

## 6-CHANNEL ELECTRONIC VOLUME

### ■ GENERAL DESCRIPTION

The **NJW1151** is a 6-CHANNEL ELECTRONIC VOLUME, which also includes tone control, balance and trim level control. The **NJW1151** is suitable for multi-channel audio system, such as AV amplifier, mini stereo component, speaker system, and others.

All of internal status and variables are controlled by I<sup>2</sup>C BUS interface.

### ■ PACKAGE OUTLINE

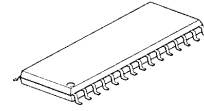

**NJW1151M**

### ■ FEATURES

- Operating Voltage +8.0 to +15.0V
- I<sup>2</sup>C BUS Interface
- 6-Chnnel Master Volume 0 to -79dB, MUTE
- Balance control for L, R-ch 0 to -30dB, MUTE
- Trim Level Control for C, SL, SR, SW-ch 0 to -20dB
- Independent Tone Control (Bass, Treble) for L, R-ch
- Bi-CMOS Technology
- Package Outline SDMP30

### ■ BLOCK DIAGRAM

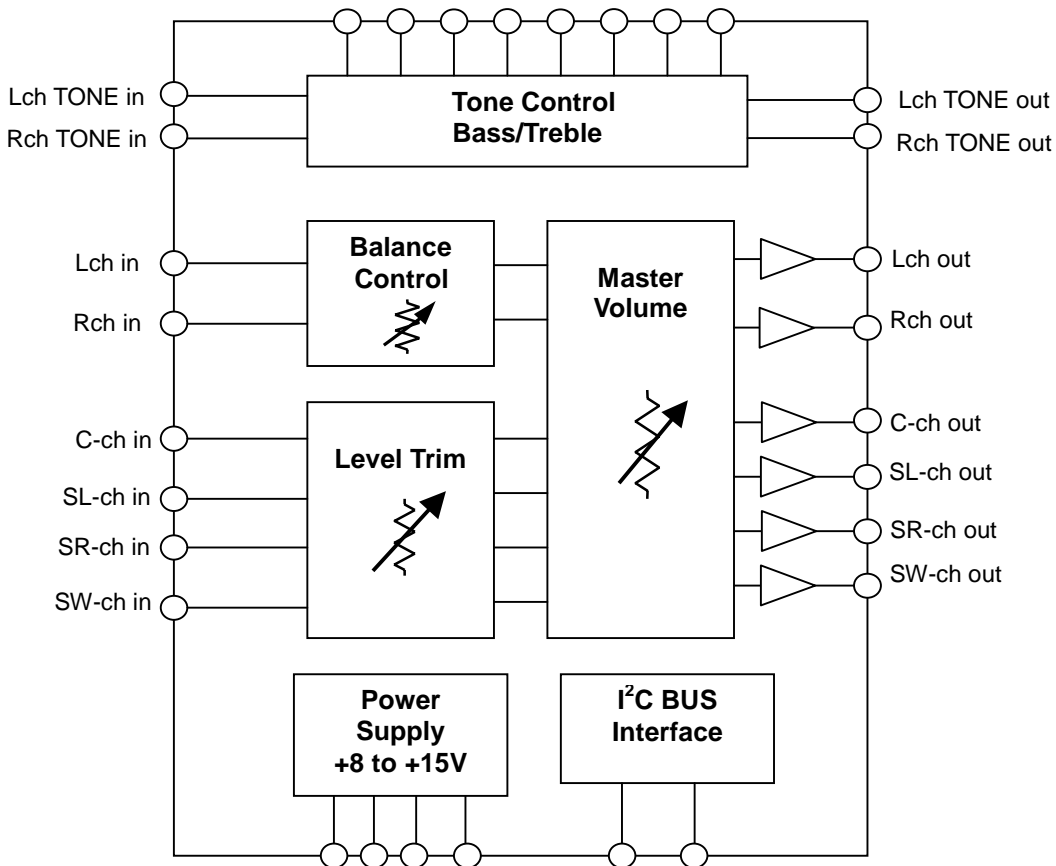

# NJW1151

## ■ PIN FUNCTION

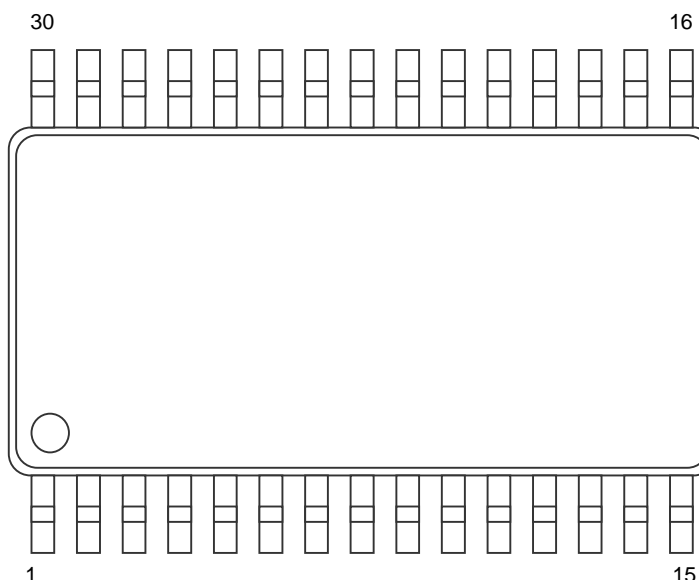

No.	SYMBOL	FUNCTION	No.	SYMBOL	FUNCTION
1	VREF	Reference voltage	16	SCL	I <sup>2</sup> C bus clock input
2	V+	Power supply voltage	17	SDA	I <sup>2</sup> C bus data input
3	VREFC	Reference voltage stabilization capacitor	18	SWOUT	Volume Sub Woofer channel output
4	RTIN	Tone control Right channel input	19	SROUT	Volume Surround Right channel output
5	RTOUT	Tone control Right channel output	20	SLOUT	Volume Surround Left channel volume output
6	RTC	Tone control Right channel Treble filter capacitor	21	COUT	Volume Center channel output
7	RBC1	Tone control Right channel Bass filter capacitor	22	ROUT	Volume Right channel output
8	RBC2	Tone control Right channel Bass filter capacitor	23	LOUT	Volume Left channel output
9	RBC3	Tone control Right channel Bass DC cut capacitor	24	LBC3	Tone control Left channel Bass DC cut capacitor
10	LIN	Volume Left channel input	25	LBC2	Tone control Left channel Bass filter capacitor
11	RIN	Volume Right channel input	26	LBC1	Tone control Left channel Bass filter capacitor
12	CIN	Volume Center channel input	27	LTC	Tone control Left channel Treble filter capacitor
13	SLIN	Volume Surround Left channel input	28	LTOUT	Tone control Left channel output
14	SRIN	Volume Surround Right channel input	29	LTIN	Tone control Left channel input
15	SWIN	Volume Sub Woofer channel input	30	GND	Ground (IC substrate)

## ■ ABSOLUTE MAXIMUM RATING (Ta=25°C)

PARAMETER	SYMBOL	RATING	UNIT
Supply Voltage	V <sup>+</sup>	+15	V
Maximum Input Voltage	V <sub>IM</sub>	V <sup>+</sup> (*)	V
Power Dissipation	P <sub>D</sub>	700	mW
Operating Temperature Range	Topr	-40 to +85	°C
Storage Temperature Range	Tstg	-40 to +125	°C

(\*) For the maximum input voltage less than 0 to V<sup>+</sup>

## ■ ELECTRICAL CHARACTERISTICS ( Ta=25°C, V<sup>+</sup>=14V, V<sub>DD</sub>=5V)

PARAMETER	SYMBOL	TEST CONDITION	MIN.	TYP.	MAX.	UNIT
<b>◆ Power Supply</b>						
Operating Voltage	V <sup>+</sup>		8.0	14.0	15.0	V
Supply Current	I <sub>CC</sub>	No Signal	-	10	30	mA
<b>◆ Input/Output Characteristics</b>						
Voltage Gain	G <sub>V</sub>	V <sub>IN</sub> =1Vrms, f=1kHz Master=0dB, Balance=0dB Trimmer=0dB	-0.5	0	0.5	dB
Voltage Gain Error	ΔG <sub>V</sub>	V <sub>IN</sub> =1Vrms, f=1kHz Master=0dB	-0.5	0	0.5	dB
Maximum Attenuation 1	A <sub>TT1</sub>	f=1kHz, V <sub>IN</sub> =1Vrms Master=-79dB	-	-79	-	dB
Maximum Attenuation 2	A <sub>TT2</sub>	f=1kHz, V <sub>IN</sub> =1Vrms Mute	-	-90	-	dB
Attenuation Error	ΔA <sub>TT</sub>	f=1kHz, V <sub>IN</sub> =1Vrms Master=-50dB Trimmer=-10dB	-1	0	1	dB
Maximum Output Voltage	V <sub>OM</sub>	f=1kHz, THD=1% Master=0dB	3.0	4.0	-	Vrms
Output Noise	V <sub>NO</sub>	Master=0dB, Rg=0, A-weight	-	-110 (3.2μ)	-100 (10μ)	dBV (Vrms)
Total Harmonic Distortion	T.H.D.	f=1kHz, Vo=1Vrms, Master=0dB, Trimmer=0dB	-	0.005	0.05	%
Channel Separation	CS	f=1kHz, Vo=1Vrms Master=0dB, A-weight	-	-90	-80	dB
<b>◆ Tone Control Characteristics</b>						
Treble Boost Gain1	HF <sub>BST</sub>	Vo=1Vrms f=10kHz Treble=10dB	8	10	12	dB
Treble Boost Gain2	HF <sub>CUT</sub>	Vo=1Vrms f=10kHz Treble=-10dB	-12	-10	-8	dB
Bass Boost Gain1	LF <sub>BST</sub>	Vo=1Vrms f=50Hz Bass=10dB	8	10	12	dB
Bass Boost Gain2	LF <sub>CUT</sub>	Vo=1Vrms f=50Hz Bass=-10dB	-12	-10	-8	dB

# NJW1151

## ■ I<sup>2</sup>C BUS Block CHARACTERISTICS (SDA, SCL)

PARAMETER	SYMBOL	MIN.	TYP.	MAX.	UNIT
High Level Input Voltage	$V_{IH}$	3.0	-	5.0	V
Low Level Input Voltage	$V_{IL}$	0	-	1.5	V
High Level Input Current	$I_{IH}$	-	-	10	$\mu$ A
Low Level Input Current	$I_{IL}$	-	-	10	$\mu$ A
Low Level Output Voltage (3mA at SDA pin)	$V_{OL}$	0	-	0.4	V
Maximum Output Current	$I_{OL}$	-3.0	-	-	mA
Maximum Clock Frequency	$f_{SCL}$	-	-	100	kHz
Data Change Minimum Waiting Time	$t_{BUF}$	4.7	-	-	$\mu$ s
Data Transfer Start Minimum Waiting Time	$t_{HD:STA}$	4.0	-	-	$\mu$ s
Low Level Clock Pulse Width	$t_{LOW}$	4.7	-	-	$\mu$ s
High Level Clock Pulse Width	$T_{HIGH}$	4.0	-	-	$\mu$ s
Minimum Start Preparation Waiting Time	$t_{SU:STA}$	4.7	-	-	$\mu$ s
Minimum Data Hold Time	$t_{HD:DAT}$	0	-	3.45	$\mu$ s
Minimum Data Preparation Time	$t_{SU:DAT}$	250	-	-	ns
Rise Time	$t_R$	-	-	1.0	$\mu$ s
Fall Time	$t_F$	-	-	300	ns
Minimum Stop Preparation Waiting Time	$t_{SU:STO}$	4.7	-	-	$\mu$ s

I<sup>2</sup>C BUS Load Condition: Pull up resistance 4k $\Omega$  (Connected to +5V)  
Load capacitance 200pF (Connected to GND)

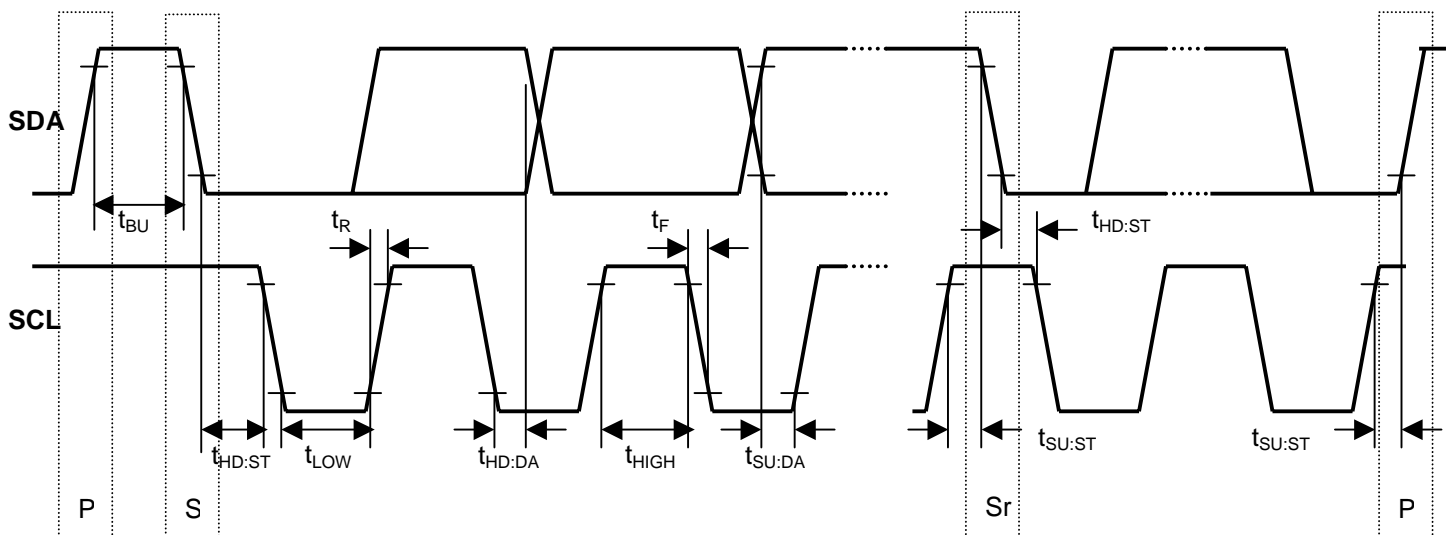

## ■ TERMINAL DESCRIPTION

No.	SYMBOL	FUNCTION	EQUIVALENT CIRCUIT	TERMINAL VOLTAGE
1	VREF	Reference voltage		$V+ / 2$
2	V+	Power supply voltage		$V+$
3	VREFC	Reference voltage stabilization capacitor		$V+ / 2$
4 29	RTIN LTIN	Tone control Right channel input Left channel input		$V+ / 2$

# NJW1151

## ■TERMINAL DESCRIPTION

No.	SYMBOL	FUNCTION	EQUIVALENT CIRCUIT	TERMINAL VOLTAGE
5 28	RTOUT LTOUT	Tone control Right channel output Left channel output		$V+ / 2$
6 27	RTC LTC	Tone control Right channel Treble filter capacitor Left channel Treble filter capacitor		$V+ / 2$
7 26	RBC1 LBC1	Tone control Right channel Bass filter capacitor Left channel Bass filter capacitor		$V+ / 2$
8 25	RBC2 LBC2	Tone control Right channel Bass filter capacitor Left channel Bass filter capacitor		$V+ / 2$

## ■ TERMINAL DESCRIPTION

No.	SYMBOL	FUNCTION	EQUIVALENT CIRCUIT	TERMINAL VOLTAGE
9 24	RBC3 LBC3	Tone control Right channel Bass DC cut capacitor Left channel Bass DC cut capacitor		$V+ / 2$
10 11 12 13 14 15	LIN RIN CIN SLIN SRIN SWIN	Volume Left channel input Right channel input Center channel input Surround Left channel input Surround Right channel input Sub Woofer channel input		$V+ / 2$
16	SCL	I <sup>2</sup> C bus clock input	<p>( Rp ; External pull up resistor )</p>	-
17	SDA	I <sup>2</sup> C bus data input	<p>( Rp ; External pull up resistor )</p>	-

# NJW1151

## ■TERMINAL DESCRIPTION

No.	SYMBOL	FUNCTION	EQUIVALENT CIRCUIT	TERMINAL VOLTAGE
18	SWOUT	Volume		$V+ / 2$
19	SROUT	Left channel output		
20	SLOUT	Right channel output		
21	COUT	Center channel output		
22	ROUT	Surround Left channel output		
23	LOUT	Surround Right channel output	Sub Woofer channel output	



## APPLICATION CIRCUIT

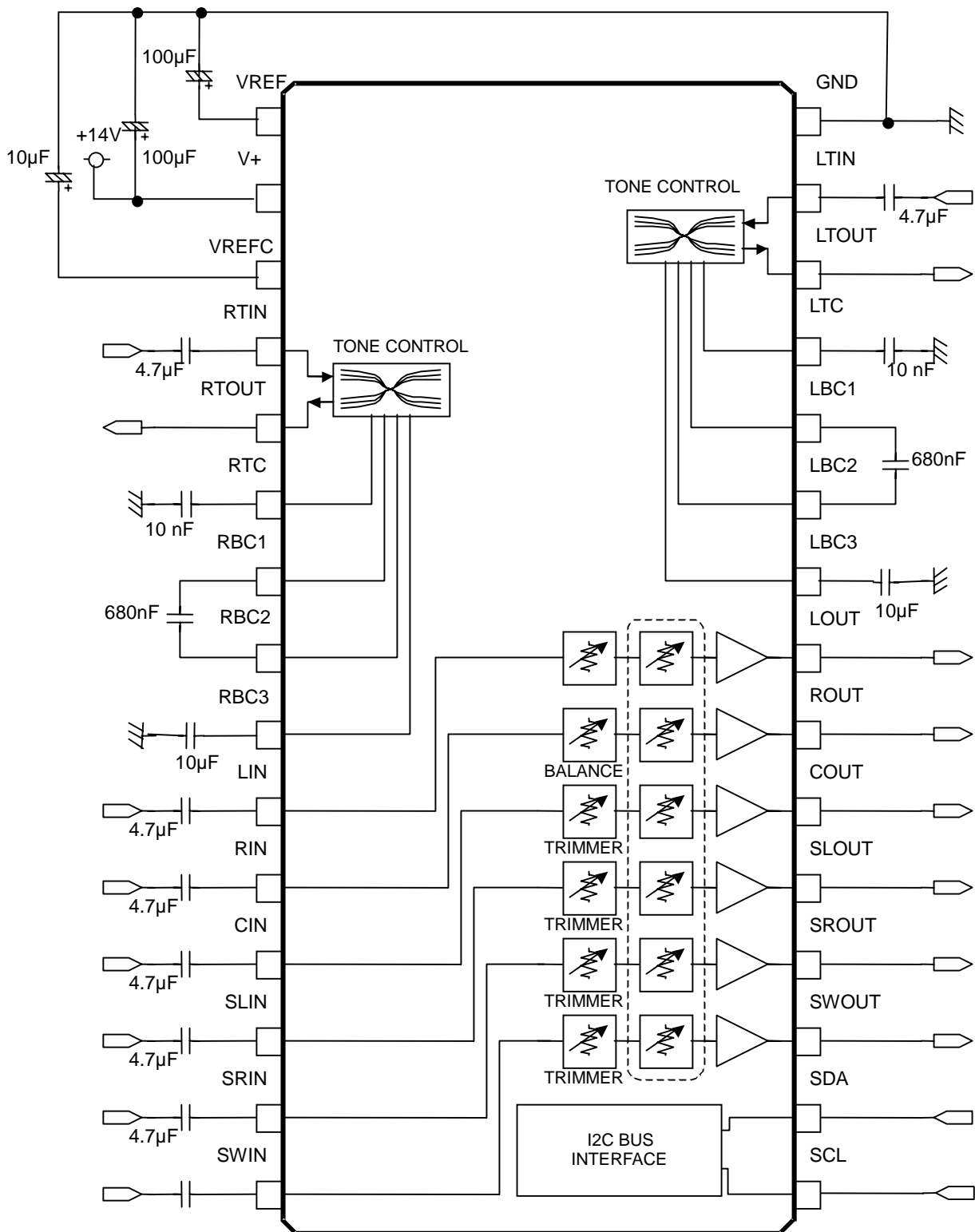

# NJW1151

## ■ Definition of cut-off frequency for Tone Control

Cut-off frequency for Tone Control is adjustable with changing the capacitor C1, C2 in below circuit.  
See the next function for the cut-off frequency.

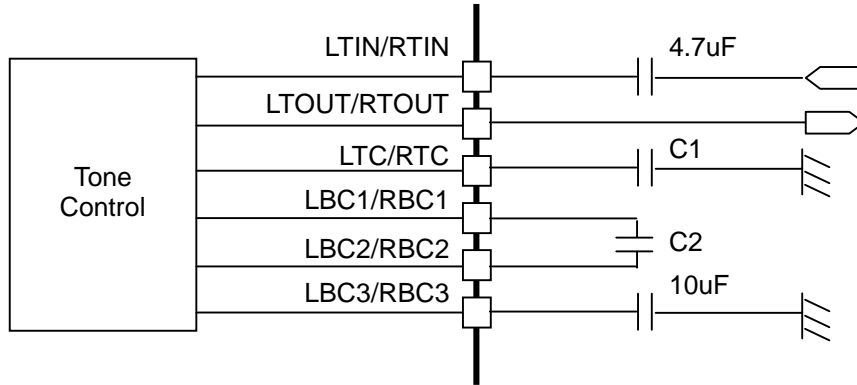

EX) C1 = 10uF, C2 = 680nF  
 Cut-off frequency for Treble = 3.9kHz  
 Cut-off frequency for Bass = 238Hz

1) TREBLE = +/-10dB

2) BASS = +/-10dB

$$f_c = \frac{39.2 * 10^{-6}}{C1}$$

$$f_c = \frac{161.7 * 10^{-6}}{C2}$$

## ■ DEFINITION OF I<sup>2</sup>C REGISTER

### ● I<sup>2</sup>C BUS FORMAT

S: Starting Term      A: Acknowledge Bit      P: Ending Term

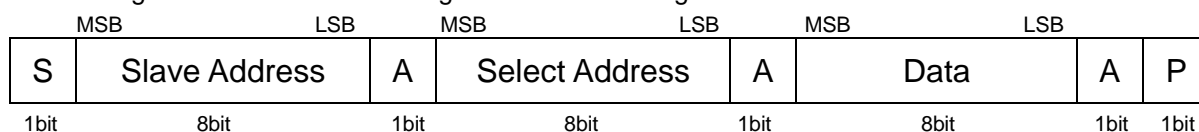

### ● SLAVE ADDRESS

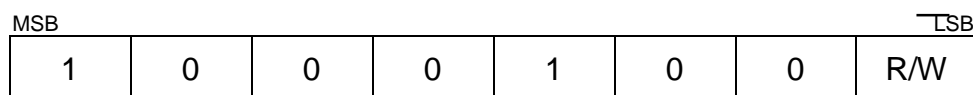

R/W=0: Receive Only

R/W=1: No Output Data

### ● CONTROL REGISTER TABLE

Select Address	BIT							
	D7	D6	D5	D4	D3	D2	D1	D0
00H	*	Master Volume						
01H		*	Left channel Balance					
02H		*	Right channel Balance					
03H		*	Center Channel Trimmer					
04H		*	SL Channel Trimmer					
05H		*	SR Channel Trimmer					
06H		*	SW Channel Trimmer					
07H	Tone (Treble)				Tone (Bass)			
08H	*	MUTE						

\* : Don't care.

On Power up, the master volume mute is activated.

### ● CONTROL REGISTER DEFAULT VALUE

Select Address	BIT							
	D7	D6	D5	D4	D3	D2	D1	D0
00H	0	1	0	1	0	0	0	0
01H	0	0	0	0	0	0	0	0
02H	0	0	0	0	0	0	0	0
03H	0	0	0	0	1	0	1	0
04H	0	0	0	0	1	0	1	0
05H	0	0	0	0	1	0	1	0
06H	0	0	0	0	1	0	1	0
07H	0	0	0	0	0	0	0	0
08H	0	0	0	0	0	0	0	0

## ● CONTROL COMMAND TABLE

Select Address	BIT								REMARKS
	D7	D6	D5	D4	D3	D2	D1	D0	
00H	*	VOL							VOL : Volume control for all channel (1dB/step) Ex.) "0000000"= 0dB "0000001"=-1dB "0000010"=- 2dB .  "1001111"=-79dB "1010000"=MUTE:Default Value Maximum Attenuation : Master Volume :-79dB Trimmer -20dB Minimum Attenuation : Master Volume 0dB Trimmer 0dB
		0	0	0	0	0	0	0	
		0	0	0	0	0	0	1	
		0	0	0	0	0	1	0	
		:	:	:	:	:	:	:	
1	0	0	1	1	1	1			
1	0	1	0	0	0	0			
01H	*	L-BAL						L-BAL : Balance control for Left channel (1dB/step) Ex.) "00000"=0dB "00001"=-1dB : : "11110"=-30dB "11111"=MUTE	
		0	0	0	0	0	0		
		0	0	0	0	0	1		
		0	0	0	1	1	0		
		:	:	:	:	:	:		
1	1	1	1	1	1				
02H	*	R-BAL						R-BAL : Balance control for Right channel (1dB/step) Ex.) "00000"=0dB "00001"=-1dB : : "11110"=-30dB "11111"= MUTE	
		0	0	0	0	0	0		
		0	0	0	0	0	1		
		0	0	0	1	1	0		
		:	:	:	:	:	:		
1	1	1	1	1	1				
03H	*	C TRIM					C TRIM :Center Channel Trimmer Control Ex.) "00000"=0dB "00001"=-1dB "00010"=-2dB : : "10100"=-20dB "00001010"=-10dB Default Value		
		0	0	0	0	0			
		0	0	0	0	1			
		0	0	0	1	0			
		:	:	:	:	:			
1	0	1	0	0					
04H	*	SL TRIM					SL TRIM :SL Channel Trimmer Control Ex.) "00000"=0dB "00001"=-1dB "00010"=-2dB : : "10100"=-20dB "00001010"=-10dB Default Value		
		0	0	0	0	0			
		0	0	0	0	1			
		0	0	0	1	0			
		:	:	:	:	:			
1	0	1	0	0					
05H	*	SR TRIM					SR TRIM :SR Channel Trimmer Control Ex.) "00000"=0dB "00001"=-1dB "00010"=-2dB : : "10100"=-20dB "00001010"=-10dB Default Value		
		0	0	0	0	0			
		0	0	0	0	1			
		0	0	0	1	0			
		:	:	:	:	:			
1	0	1	0	0					
06H	*	SW TRIM					SW TRIM :SW Channel Trimmer Control Ex.) "00000"=0dB "00001"=-1dB "00010"=-2dB : : "10100"=-20dB "00001010"=-10dB Default Value		
		0	0	0	0	0			
		0	0	0	0	1			
		0	0	0	1	0			
		:	:	:	:	:			
1	0	1	0	0					

## ● CONTROL COMMAND TABLE

Select Address	BIT								REMARKS
	D7	D6	D5	D4	D3	D2	D1	D0	
07H	TREBLE				BASS				TONE CONTROL Ex.) "11011101"=+10dB "11001100"=+8dB : "10001000"=0dB "00000000"=0dB : "01000111"=-8dB "01010101"=-10dB
	1	1	0	1	1	1	0	1	
	1	1	0	0	1	1	0	0	
	:								
	1	0	0	0	1	0	0	0	
	0	0	0	0	0	0	0	0	
	:								
0	1	0	0	0	1	0	0		
0	1	0	1	0	1	0	1		
08H	MUTE								MUTE CONTROL Ex.) "0"=OFF "1"=MUTE D5=L ch,D4=R ch,D3=C ch,D2=SL ch,D1=SR ch,D0=SW ch
	0								
	1								

## TYPICAL CHARACTERISTICS

Operating Current vs. Supply Voltage  
Ta=25°C

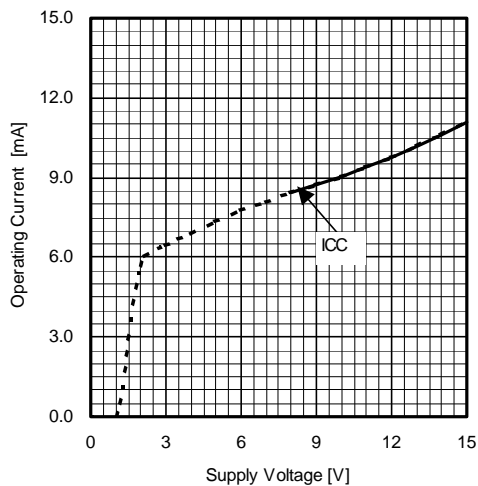

Volume Attenuation Level vs. Setting Level  
V+=14V f=1kHz Ta=25°C

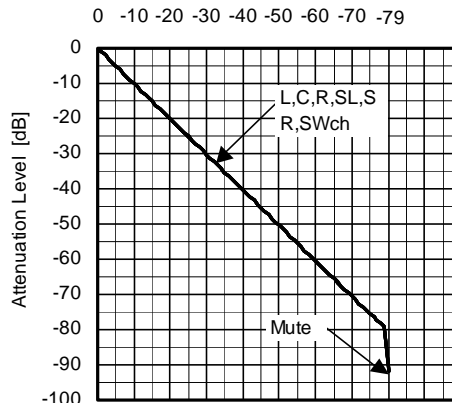

Tone Control Voltage Gain vs Frequency  
V+=14V Vin=1Vrms Ta=25°C

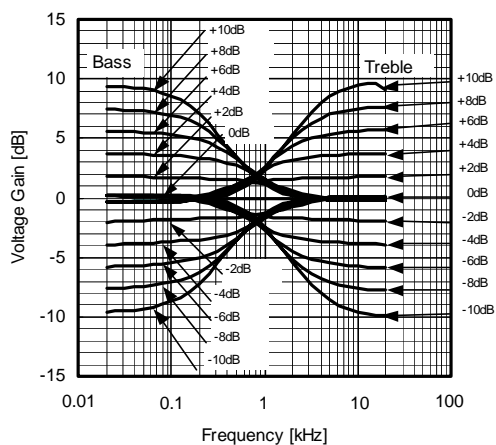

Volume THD+N vs. Input Level  
Vin=1Vrms V+=14V Ta=25°C

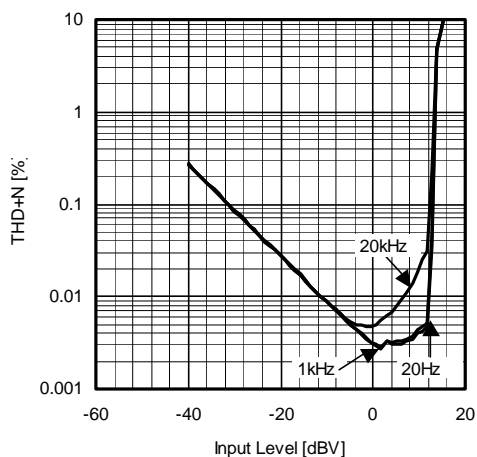

Volume THD+N vs. Input Level  
V+=14V Ta=25°C

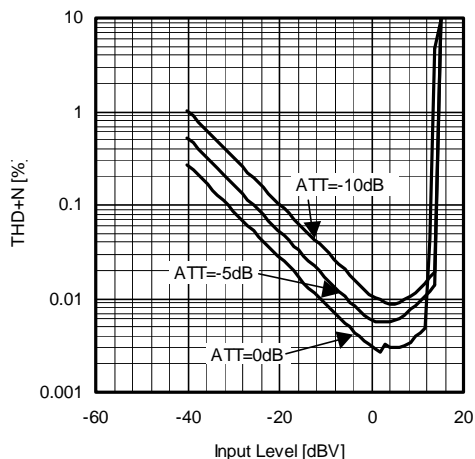

Tone Control THD+N vs. Input Level  
(ATT=0dB; Flat)  
Vin=1Vrms V+=14V Ta=25°C

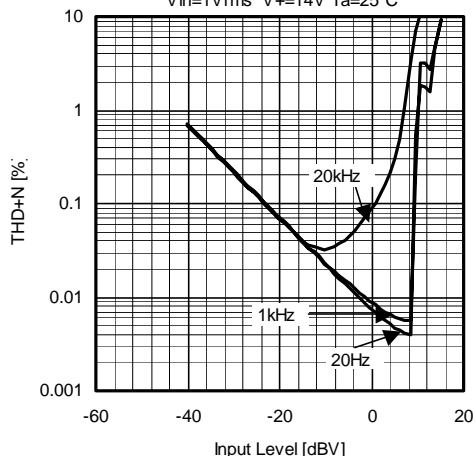

## TYPICAL CHARACTERISTICS

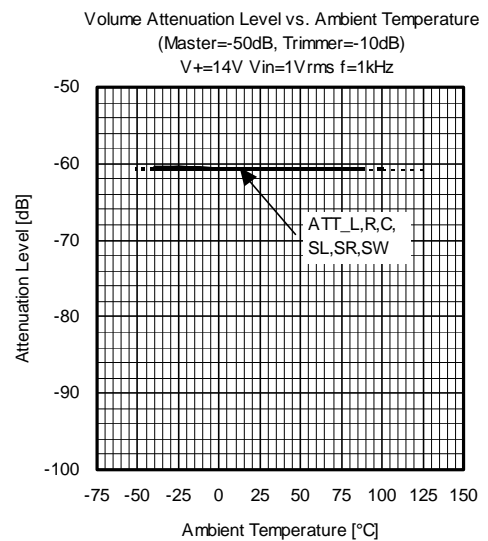
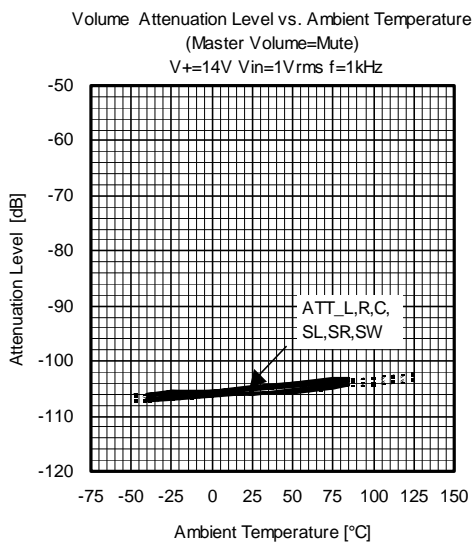
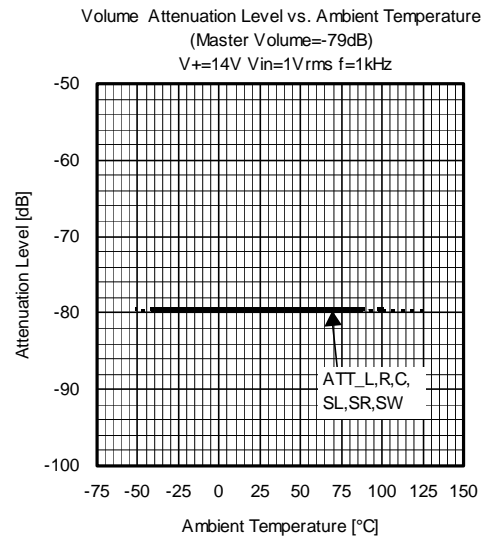
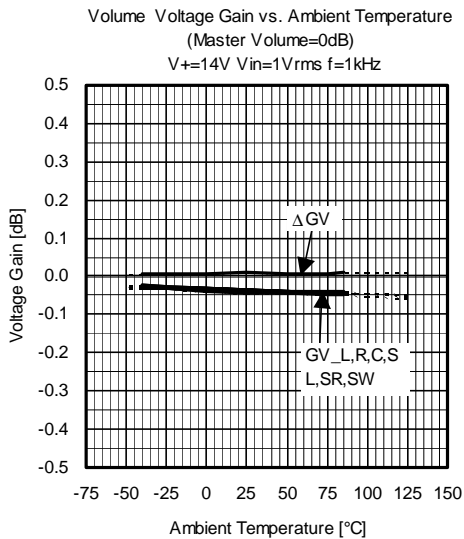
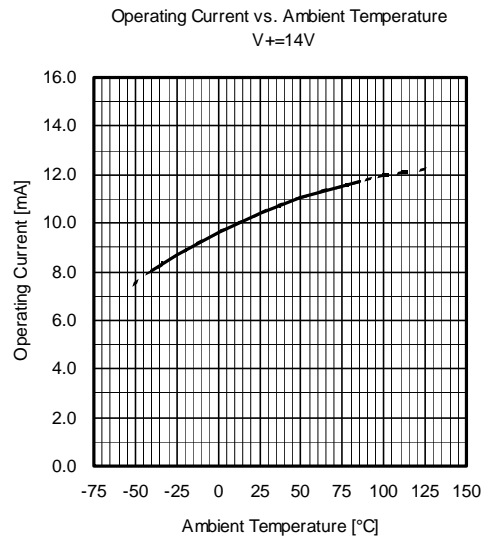
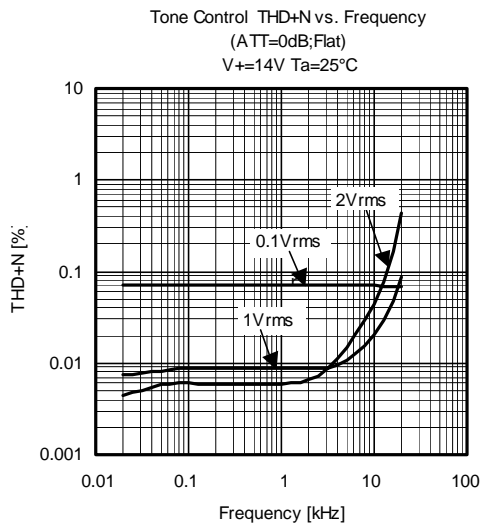

## ■ TYPICAL CHARACTERISTICS

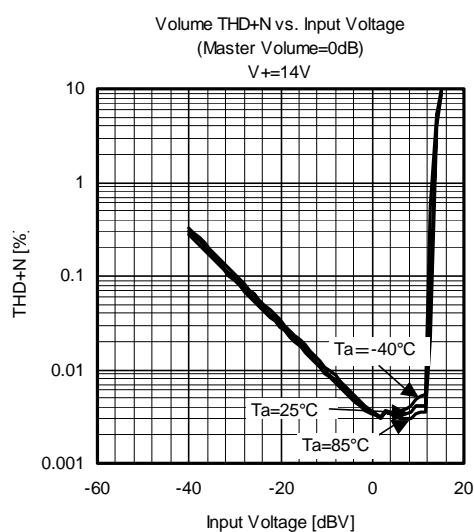
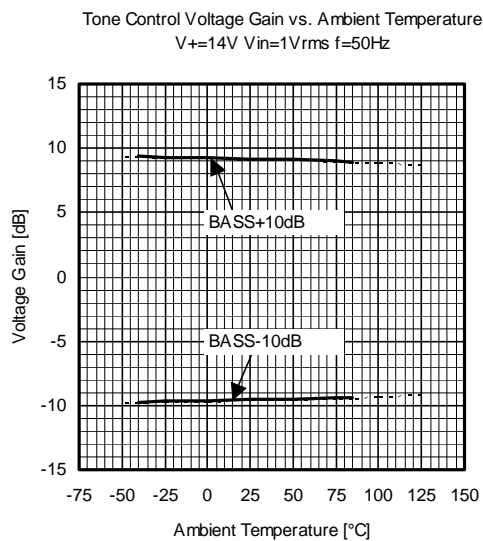
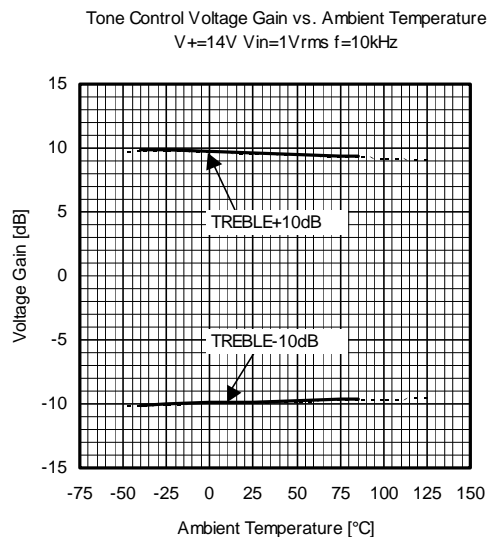
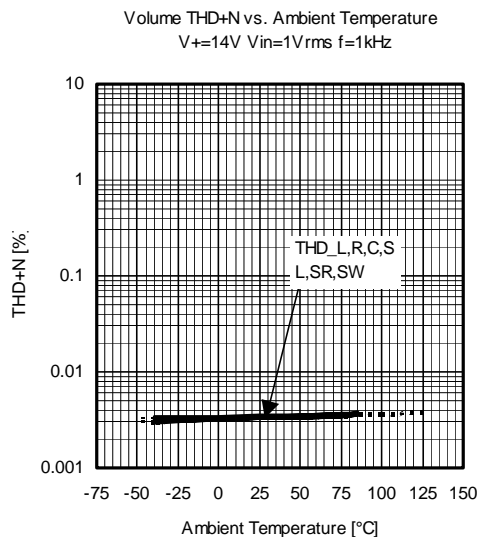
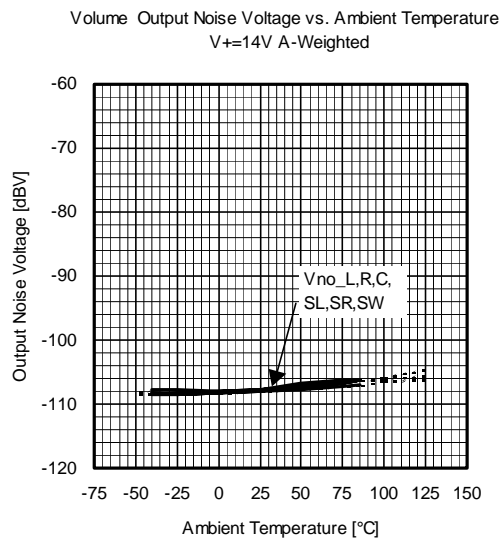
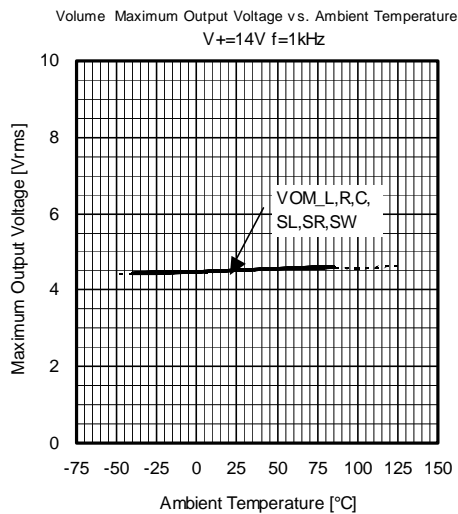



## ■ TYPICAL CHARACTERISTICS

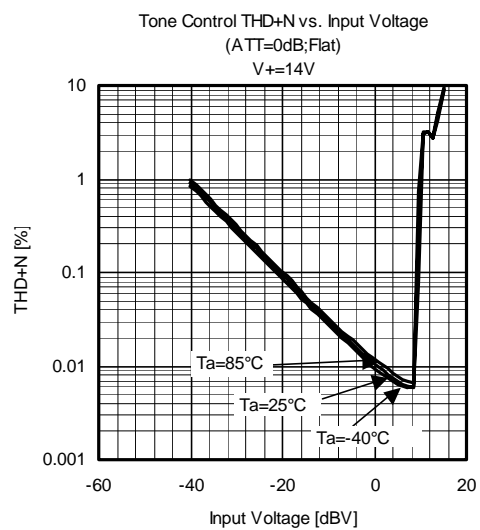

**[CAUTION]**

The specifications on this databook are only given for information, without any guarantee as regards either mistakes or omissions. The application circuits in this databook are described only to show representative usages of the product and not intended for the guarantee or permission of any right including the industrial rights.