

# NL17SZ74

## Single D Flip Flop

The NL17SZ74 is a high performance, full function Edge triggered D Flip Flop, with all the features of a standard logic device such as the 74LCX74.

- Extremely High Speed:  $t_{PD}$  2.6 ns (typical) at  $V_{CC} = 5$  V
- Designed for 1.65 V to 5.5 V  $V_{CC}$  Operation
- 5 V Tolerant Inputs – Interface Capability with 5 V TTL Logic
- LVTTTL Compatible
- LVCMOS Compatible
- 24 mA Balanced Output Sink and Source Capability
- Near Zero Static Supply Current (10  $\mu$ A) Substantially Reduces System Power Requirements
- Replacement for NC7SZ74
- Tiny Ultra Small Package Only 2.1 X 3.0 mm
- High ESD Ratings: 2000 V Human Body Model  
200 V Machine Model
- Chip Complexity: FET = 64

### TRUTH TABLE

Inputs				Outputs		Operating Mode
PR	CLR	CP	D	Q	$\bar{Q}$	
L	H	X	X	H	L	Asynchronous Set Asynchronous Clear Undetermined
H	L	X	X	L	H	
L	L	X	X	H	H	
H	H	$\uparrow$	h	H	L	Load and Read Register
H	H	$\uparrow$	l	L	H	
H	H	$\uparrow$	X	NC	NC	Hold

- H = High Voltage Level
- h = High Voltage Level One Setup Time Prior to the Low-to-High Clock Transition
- L = Low Voltage Level
- l = Low Voltage Level One Setup Time Prior to the Low-to-High Clock Transition
- NC = No Change
- X = High or Low Voltage Level and Transitions are Acceptable
- $\uparrow$  = Low-to-High Transition
- $\uparrow$  = Not a Low-to-High Transition

For  $I_{CC}$  reasons, DO NOT FLOAT Inputs



ON Semiconductor®

<http://onsemi.com>

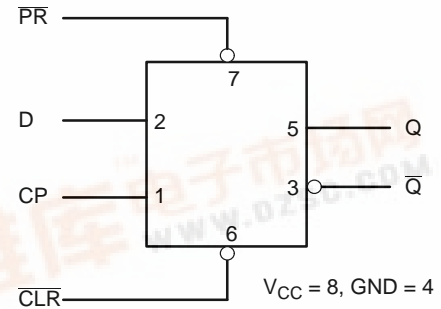
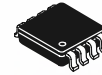
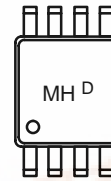

Figure 1. Logic Diagram



US8  
CASE 493  
US SUFFIX

### MARKING DIAGRAM



MH = Specific Device Code  
D = Date Code

### PINOUT

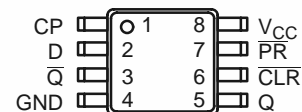

### ORDERING INFORMATION

Device	Package	Shipping
NL17SZ74US	US8	3000/Tape & Reel



# NL17SZ74

## MAXIMUM RATINGS

Symbol	Parameter	Value	Unit
V <sub>CC</sub>	DC Supply Voltage	-0.5 to +7.0	V
V <sub>I</sub>	DC Input Voltage	-0.5 to +7.0	V
V <sub>O</sub>	DC Output Voltage – Output in High or Low State (Note 1)	-0.5 to V <sub>CC</sub> +0.5	V
I <sub>IK</sub>	DC Input Diode Current V <sub>I</sub> < GND	-50	mA
I <sub>OK</sub>	DC Output Diode Current V <sub>O</sub> < GND	-50	mA
I <sub>O</sub>	DC Output Sink Current	±50	mA
I <sub>CC</sub>	DC Supply Current Per Supply Pin	±100	mA
I <sub>GND</sub>	DC Ground Current Per Ground Pin	±100	mA
T <sub>STG</sub>	Storage Temperature Range	-65 to +150	°C
T <sub>L</sub>	Lead Temperature, 1 mm from Case for 10 Seconds	260	°C
T <sub>J</sub>	Junction Temperature Under Bias	+150	°C
θ <sub>JA</sub>	Thermal Resistance (Note 2)	250	°C/W
P <sub>D</sub>	Power Dissipation in Still Air at 85°C	250	mW
MSL	Moisture Sensitivity	Level 1	
F <sub>R</sub>	Flammability Rating Oxygen Index: 28 to 34	UL 94 V-0 @ 0.125 in	
V <sub>ESD</sub>	ESD Withstand Voltage Human Body Model (Note 3) Machine Model (Note 4) Charged Device Model (Note 5)	>2000 >200 N/A	V

Maximum Ratings are those values beyond which damage to the device may occur. Exposure to these conditions or conditions beyond those indicated may adversely affect device reliability. Functional operation under absolute maximum-rated conditions is not implied. Functional operation should be restricted to the Recommended Operating Conditions.

1. I<sub>O</sub> absolute maximum rating must be observed.
2. Measured with minimum pad spacing on an FR4 board, using 10 mm X 1 inch, 2 ounce copper trace with no air flow.
3. Tested to EIA/JESD22-A114-A.
4. Tested to EIA/JESD22-A115-A.
5. Tested to JESD22-C101-A.

## RECOMMENDED OPERATING CONDITIONS

Symbol	Parameter	Min	Max	Unit
V <sub>CC</sub>	Supply Voltage Operating Data Retention Only	1.65 1.5	5.5 5.5	V
V <sub>I</sub>	Input Voltage (Note 6)	0	5.5	V
V <sub>O</sub>	Output Voltage (HIGH or LOW State)	0	V <sub>CC</sub>	V
T <sub>A</sub>	Operating Free-Air Temperature	-40	+85	°C
Δt/ΔV	Input Transition Rise or Fall Rate V <sub>CC</sub> = 2.5 V ±0.2 V V <sub>CC</sub> = 3.0 V ±0.3 V V <sub>CC</sub> = 5.0 V ±0.5 V	0 0 0	20 10 5.0	ns/V

6. Unused inputs may not be left open. All inputs must be tied to a high-logic voltage level or a low-logic input voltage level.

# NL17SZ74

## DC ELECTRICAL CHARACTERISTICS

Symbol	Parameter	Condition	V <sub>CC</sub> (V)	T <sub>A</sub> = 25°C			-40°C ≤ T <sub>A</sub> ≤ 85°C		Unit
				Min	Typ	Max	Min	Max	
V <sub>IH</sub>	High-Level Input Voltage		1.65	0.75 V <sub>CC</sub>			0.75 V <sub>CC</sub>		V
			2.3 to 5.5	0.7 V <sub>CC</sub>			0.7 V <sub>CC</sub>		
V <sub>IL</sub>	Low-Level Input Voltage		1.65			0.25 V <sub>CC</sub>		0.25 V <sub>CC</sub>	V
			2.3 to 5.5			0.3 V <sub>CC</sub>		0.3 V <sub>CC</sub>	
V <sub>OH</sub>	High-Level Output Voltage V <sub>IN</sub> = V <sub>IL</sub> or V <sub>IH</sub>	I <sub>OH</sub> = 100 μA	1.65 to 5.5	V <sub>CC</sub> - 0.1	V <sub>CC</sub>		V <sub>CC</sub> - 0.1		V
		I <sub>OH</sub> = -3 mA	1.65	1.29	1.52		1.29		
		I <sub>OH</sub> = -8 mA	2.3	1.9	2.1		1.9		
		I <sub>OH</sub> = -12 mA	2.7	2.2	2.4		2.2		
		I <sub>OH</sub> = -16 mA	3.0	2.4	2.7		2.4		
		I <sub>OH</sub> = -24 mA	3.0	2.3	2.5		2.3		
		I <sub>OH</sub> = -32 mA	4.5	3.8	4.0		3.8		
V <sub>OL</sub>	Low-Level Output Voltage V <sub>IN</sub> = V <sub>IH</sub>	I <sub>OL</sub> = 100 μA	1.65 to 5.5		0.008	0.1		0.1	V
		I <sub>OL</sub> = 3 mA	1.65		0.10	0.24		0.24	
		I <sub>OL</sub> = 8 mA	2.3		0.12	0.3		0.3	
		I <sub>OL</sub> = 12 mA	2.7		0.15	0.4		0.4	
		I <sub>OL</sub> = 16 mA	3.0		0.19	0.4		0.4	
		I <sub>OL</sub> = 24 mA	3.0		0.30	0.55		0.55	
		I <sub>OL</sub> = 32 mA	4.5		0.30	0.55		0.55	
I <sub>IN</sub>	Input Leakage Current	V <sub>IN</sub> = V <sub>CC</sub> or GND	5.5			±0.1		±1.0	μA
I <sub>OFF</sub>	Power off Input Leakage Current	5.5V or V <sub>IN</sub> = GND	0			1.0		10	μA
I <sub>CC</sub>	Quiescent Supply Current	V <sub>IN</sub> = V <sub>CC</sub> or GND	5.5			1.0		10	μA

# NL17SZ74

## AC ELECTRICAL CHARACTERISTICS (Input $t_r = t_f = 3.0$ ns)

Symbol	Parameter	V <sub>CC</sub> (V)	Test Conditions	T <sub>A</sub> = 25°C			T <sub>A</sub> = -40 to 85°C		Unit
				Min	Typ	Max	Min	Max	
f <sub>MAX</sub>	Maximum Clock Frequency (50% Duty Cycle) (Waveform 1)	1.8 ± 0.15	C <sub>L</sub> = 15 pF R <sub>D</sub> = 1 MΩ S <sub>1</sub> = Open	75			75		MHz
		2.5 ± 0.2		150			150		
		3.3 ± 0.3		200			200		
		5.0 ± 0.5		250			250		
		3.3 ± 0.3	C <sub>L</sub> = 50 pF, R <sub>D</sub> = 500 Ω, S <sub>1</sub> = Open	175			175		
		5.0 ± 0.5		200			200		
t <sub>PLH</sub> , t <sub>PHL</sub>	Propagation Delay, CP to Q or Q̄ (Waveform 1)	1.8 ± 0.15	C <sub>L</sub> = 15 pF R <sub>D</sub> = 1 MΩ S <sub>1</sub> = Open	2.5	6.5	12.5	2.5	13	ns
		2.5 ± 0.2		1.5	3.8	7.5	1.5	8.0	
		3.3 ± 0.3		1.0	2.8	6.5	1.0	7.0	
		5.0 ± 0.5		0.8	2.2	4.5	0.8	5.0	
		3.3 ± 0.3	C <sub>L</sub> = 50 pF, R <sub>D</sub> = 500 Ω, S <sub>1</sub> = Open	1.0	3.4	7.0	1.0	7.5	
		5.0 ± 0.5		1.0	2.6	5.0	1.0	5.5	
t <sub>PLH</sub> , t <sub>PHL</sub>	Propagation Delay, PR or CLR to Q or Q̄ (Waveform 2)	1.8 ± 0.15	C <sub>L</sub> = 15 pF R <sub>D</sub> = 1 MΩ S <sub>1</sub> = Open	2.5	6.5	14	2.5	14.5	ns
		2.5 ± 0.2		1.5	3.8	9.0	1.5	9.5	
		3.3 ± 0.3		1.0	2.8	6.5	1.0	7.0	
		5.0 ± 0.5		0.8	2.2	5.0	0.8	5.5	
		3.3 ± 0.3	C <sub>L</sub> = 50 pF, R <sub>D</sub> = 500 Ω, S <sub>1</sub> = Open	1.0	3.4	7.0	1.0	7.5	
		5.0 ± 0.5		1.0	2.6	5.0	1.0	5.5	
t <sub>S</sub>	Setup Time, D to CP (Waveform 1)	1.8 ± 0.15	C <sub>L</sub> = 15 pF R <sub>D</sub> = 1 MΩ S <sub>1</sub> = Open	6.5			6.5		ns
		2.5 ± 0.2		3.5			3.5		
		3.3 ± 0.3		2.0			2.0		
		5.0 ± 0.5		1.5			1.5		
		3.3 ± 0.3	C <sub>L</sub> = 50 pF, R <sub>D</sub> = 500 Ω, S <sub>1</sub> = Open	2.0			2.0		
		5.0 ± 0.5		1.5			1.5		
t <sub>H</sub>	Hold Time, D to CP (Waveform 1)	1.8 ± 0.15	C <sub>L</sub> = 15 pF R <sub>D</sub> = 1 MΩ S <sub>1</sub> = Open	0.5			0.5		ns
		2.5 ± 0.2		0.5			0.5		
		3.3 ± 0.3		0.5			0.5		
		5.0 ± 0.5		0.5			0.5		
		3.3 ± 0.3	C <sub>L</sub> = 50 pF, R <sub>D</sub> = 500 Ω, S <sub>1</sub> = Open	0.5			0.5		
		5.0 ± 0.5		0.5			0.5		
t <sub>W</sub>	Pulse Width, CP, CLR, PR (Waveform 3)	1.8 ± 0.15	C <sub>L</sub> = 15 pF R <sub>D</sub> = 1 MΩ S <sub>1</sub> = Open	6.0			6.0		ns
		2.5 ± 0.2		4.0			4.0		
		3.3 ± 0.3		3.0			3.0		
		5.0 ± 0.5		2.0			2.0		
		3.3 ± 0.3	C <sub>L</sub> = 50 pF, R <sub>D</sub> = 500 Ω, S <sub>1</sub> = Open	3.0			3.0		
		5.0 ± 0.5		2.0			2.0		
t <sub>REC</sub>	Recover Time PR; CLR to CP (Waveform 3)	1.8 ± 0.15	C <sub>L</sub> = 15 pF R <sub>D</sub> = 1 MΩ S <sub>1</sub> = Open	8.0			8.0		MHz
		2.5 ± 0.2		4.5			4.5		
		3.3 ± 0.3		3.0			3.0		
		5.0 ± 0.5		3.0			3.0		
		3.3 ± 0.3	C <sub>L</sub> = 50 pF, R <sub>D</sub> = 500 Ω, S <sub>1</sub> = Open	3.0			3.0		
		5.0 ± 0.5		3.0			3.0		

7. C<sub>PD</sub> is defined as the value of the internal equivalent capacitance which is calculated from the operating current consumption without load. Average operating current can be obtained by the equation: I<sub>CC(OPR)</sub> = C<sub>PD</sub> • V<sub>CC</sub> • f<sub>in</sub> + I<sub>CC</sub>/2 (per flip-flop). C<sub>PD</sub> is used to determine the no-load dynamic power consumption; P<sub>D</sub> = C<sub>PD</sub> • V<sub>CC</sub><sup>2</sup> • f<sub>in</sub> + I<sub>CC</sub> • V<sub>CC</sub>.

## NL17SZ74

### CAPACITANCE (Note 8)

Symbol	Parameter	Condition	Typical	Unit
C <sub>IN</sub>	Input Capacitance	V <sub>CC</sub> = 5.5 V	7.0	pF
C <sub>OUT</sub>	Output Capacitance	V <sub>CC</sub> = 5.5 V	7.0	pF
C <sub>PD</sub>	Power Dissipation Capacitance (Note 9) Frequency = 10 MHz	V <sub>CC</sub> = 3.3 V	16	pF
		V <sub>CC</sub> = 5.0 V	21	

8. T<sub>A</sub> = +25°C, f = 1 MHz

9. C<sub>PD</sub> is defined as the value of the internal equivalent capacitance which is derived from dynamic operating current consumption (I<sub>CCD</sub>) at no output loading and operating at 50% duty cycle. (See Figure 2) C<sub>PD</sub> is related to I<sub>CCD</sub> dynamic operating current by the expression:

$$I_{CCD} = C_{PD} \cdot V_{CC} \cdot f_{in} + I_{CC(static)}$$

## NL17SZ74

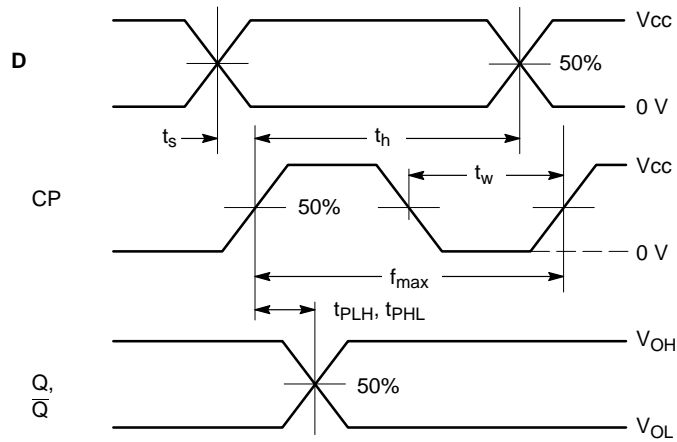

**WAVEFORM 1 – PROPAGATION DELAYS, SETUP AND HOLD TIMES**

$t_R = t_F = 3.0$  ns, 10% to 90%;  $f = 1$  MHz;  $t_w = 500$  ns

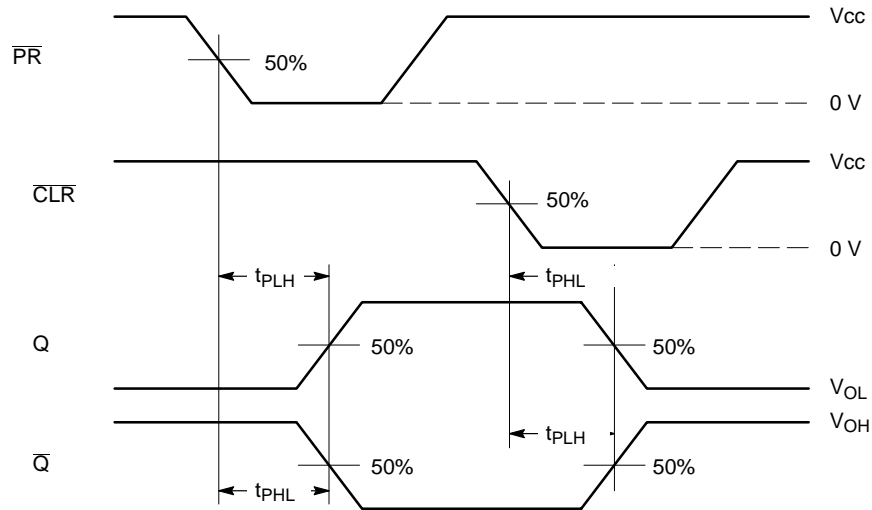

**WAVEFORM 2 – PROPAGATION DELAYS**

$t_R = t_F = 3.0$  ns, 10% to 90%;  $f = 1$  MHz;  $t_w = 500$  ns

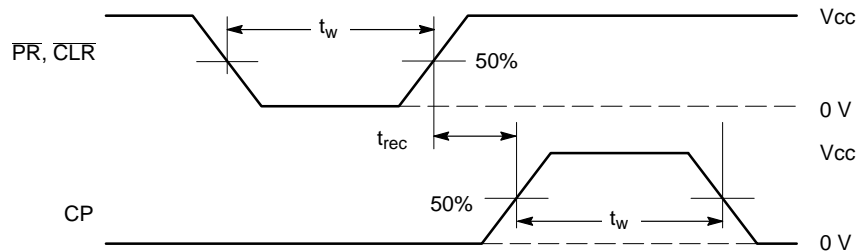

**WAVEFORM 3 – RECOVERY TIME**

$t_R = t_F = 3.0$  ns from 10% to 90%;  $f = 1$  MHz;  $t_w = 500$  ns  
Output Reg:  $V_{OL} \leq 0.8$  V,  $V_{OH} \geq 2.0$  V

**Figure 2. AC Waveforms**

# NL17SZ74

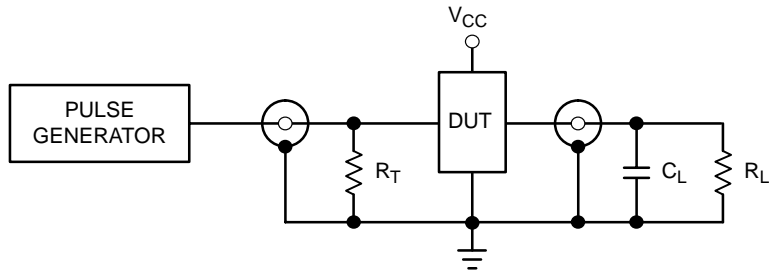

Figure 3. Test Circuit

## DEVICE ORDERING INFORMATION

Device Order Number	Device Nomenclature						Package Type	Tape and Reel Size
	Logic Circuit Indicator	No. of Gates per Package	Temp Range Identifier	Technology	Device Function	Package Suffix		
NL17SZ74US	NL	1	7	SZ	74	US	US8	178 mm, 3000 Unit

# NL17SZ74

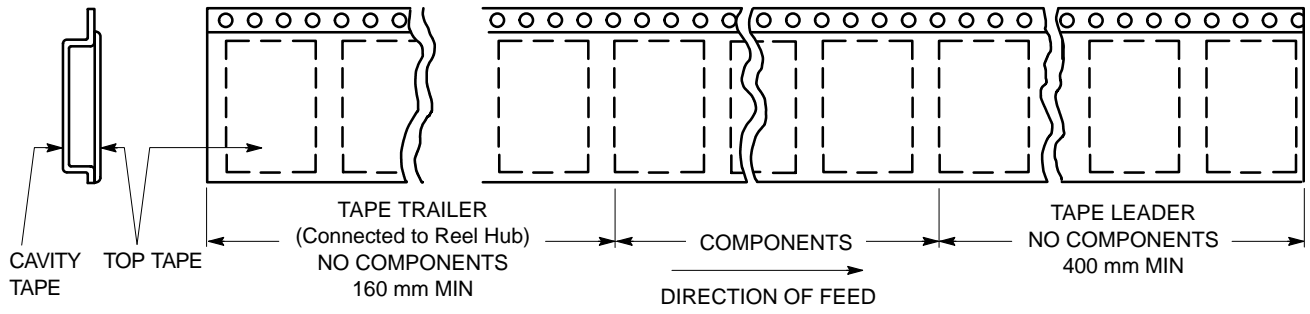

Figure 4. Tape Ends for Finished Goods

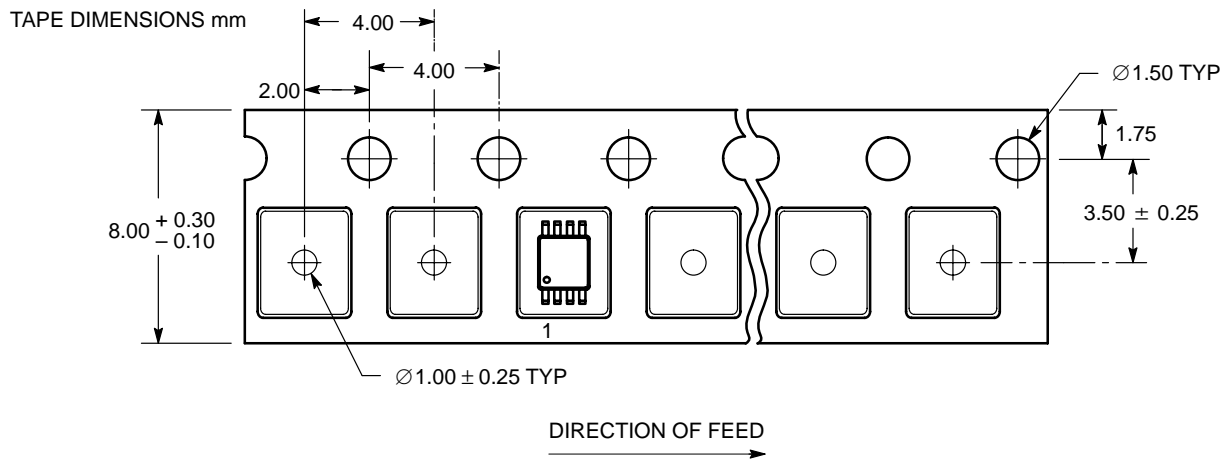

Figure 5. US8 Reel Configuration/Orientation



# NL17SZ74

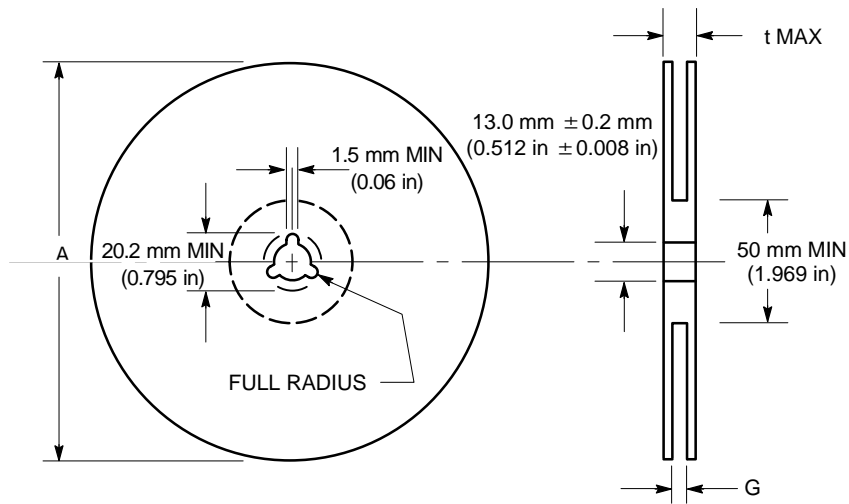

Figure 6. Reel Dimensions

## REEL DIMENSIONS

Tape Size	T and R Suffix	A Max	G	t Max
8 mm	US	178 mm (7 in)	8.4 mm, + 1.5 mm, -0.0 (0.33 in + 0.059 in, -0.00)	14.4 mm (0.56 in)

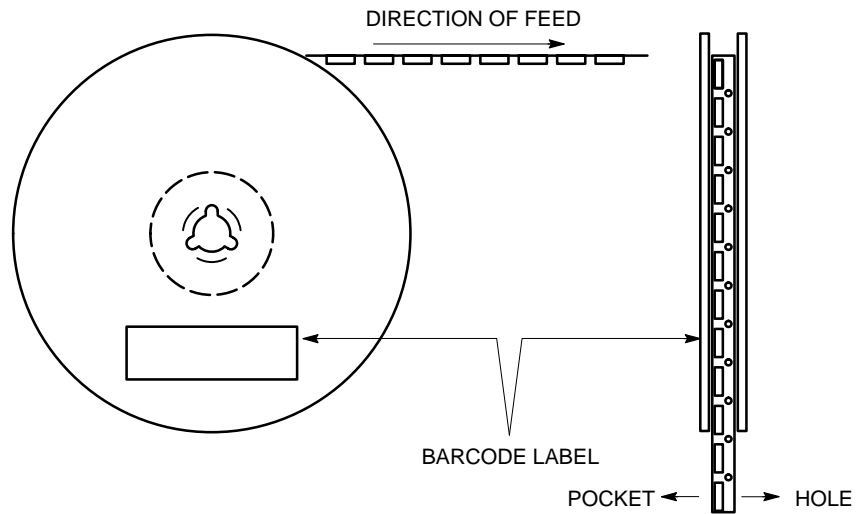
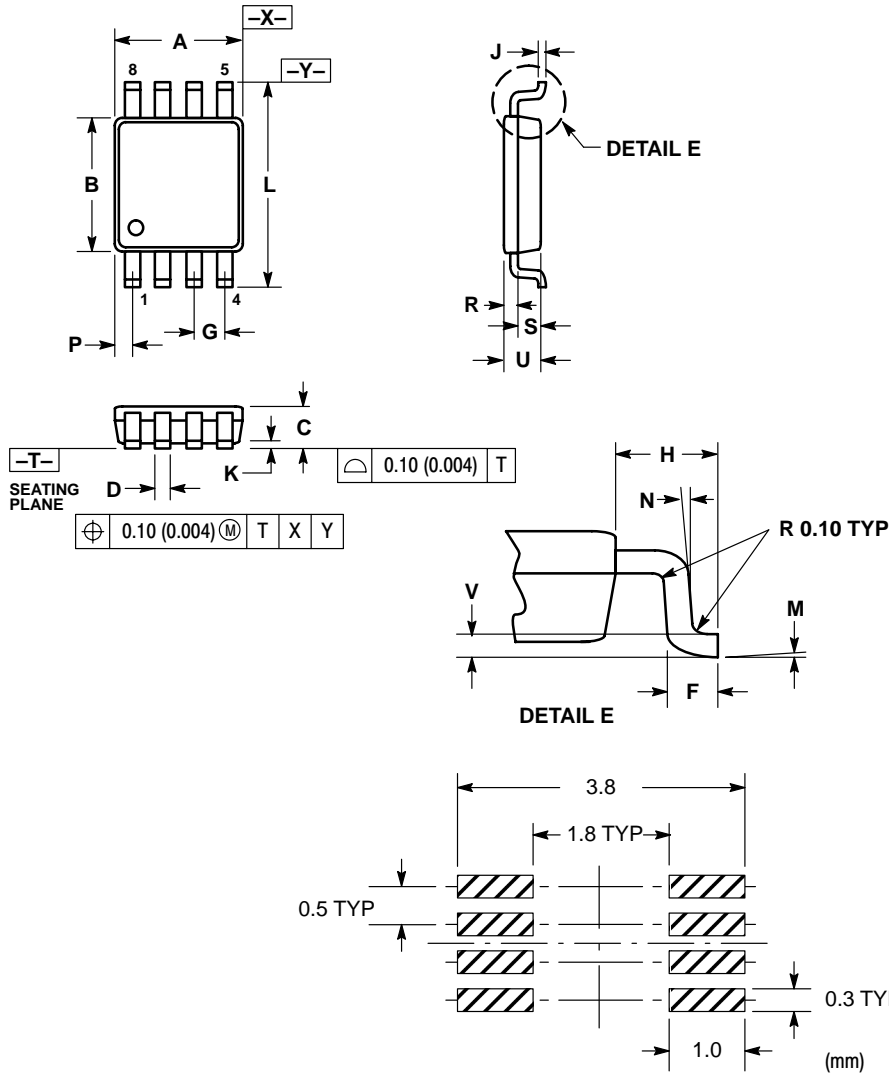

Figure 7. Reel Winding Direction

# NL17SZ74

## PACKAGE DIMENSIONS

US8  
US SUFFIX  
CASE 493-01  
ISSUE O



### NOTES:

1. DIMENSIONING AND TOLERANCING PER ANSI Y14.5M, 1982.
2. CONTROLLING DIMENSION: MILLIMETERS
3. DIMENSION "A" DOES NOT INCLUDE MOLD FLASH, PROTRUSION OR GATE BURR. MOLD FLASH, PROTRUSION AND GATE BURR SHALL NOT EXCEED 0.140 MM (0.0055") PER SIDE.
4. DIMENSION "B" DOES NOT INCLUDE INTER-LEAD FLASH OR PROTRUSION. INTER-LEAD FLASH AND PROTRUSION SHALL NOT EXCEED 0.140 (0.0055") PER SIDE.
5. LEAD FINISH IS SOLDER PLATING WITH THICKNESS OF 0.0076-0.0203 MM. (300-800 mINCH).
6. ALL TOLERANCE UNLESS OTHERWISE SPECIFIED  $\pm 0.0508$  (0.0002").

NL17SZ74

**Notes**

## NL17SZ74

**ON Semiconductor** and  are registered trademarks of Semiconductor Components Industries, LLC (SCILLC). SCILLC reserves the right to make changes without further notice to any products herein. SCILLC makes no warranty, representation or guarantee regarding the suitability of its products for any particular purpose, nor does SCILLC assume any liability arising out of the application or use of any product or circuit, and specifically disclaims any and all liability, including without limitation special, consequential or incidental damages. "Typical" parameters which may be provided in SCILLC data sheets and/or specifications can and do vary in different applications and actual performance may vary over time. All operating parameters, including "Typicals" must be validated for each customer application by customer's technical experts. SCILLC does not convey any license under its patent rights nor the rights of others. SCILLC products are not designed, intended, or authorized for use as components in systems intended for surgical implant into the body, or other applications intended to support or sustain life, or for any other application in which the failure of the SCILLC product could create a situation where personal injury or death may occur. Should Buyer purchase or use SCILLC products for any such unintended or unauthorized application, Buyer shall indemnify and hold SCILLC and its officers, employees, subsidiaries, affiliates, and distributors harmless against all claims, costs, damages, and expenses, and reasonable attorney fees arising out of, directly or indirectly, any claim of personal injury or death associated with such unintended or unauthorized use, even if such claim alleges that SCILLC was negligent regarding the design or manufacture of the part. SCILLC is an Equal Opportunity/Affirmative Action Employer.

### PUBLICATION ORDERING INFORMATION

**Literature Fulfillment:**

Literature Distribution Center for ON Semiconductor  
P.O. Box 5163, Denver, Colorado 80217 USA  
**Phone:** 303-675-2175 or 800-344-3860 Toll Free USA/Canada  
**Fax:** 303-675-2176 or 800-344-3867 Toll Free USA/Canada  
**Email:** ONlit@hibbertco.com

**N. American Technical Support:** 800-282-9855 Toll Free USA/Canada

**JAPAN:** ON Semiconductor, Japan Customer Focus Center  
4-32-1 Nishi-Gotanda, Shinagawa-ku, Tokyo, Japan 141-0031  
**Phone:** 81-3-5740-2700  
**Email:** r14525@onsemi.com

**ON Semiconductor Website:** <http://onsemi.com>

For additional information, please contact your local Sales Representative.