

**14 cm (5.5 inches), 320 × 240 Pixels, Full color
NTSC/PAL mode, Wide temperature range**

DESCRIPTION

NL3224AC35-01 and NL3224AC35-13 are TFT (thin film transistor) active matrix color liquid crystal displays (LCD) comprising amorphous silicon TFT attached to each signal electrode, a driving circuit and a backlight. Both the products have a built-in backlight.

Their 14 cm diagonal display area contain 320 × 240 pixels and can display full-color simultaneously.

The difference between NL3224AC35-01 and NL3224AC35-13 is as follows:

- NL3224AC35-01: Antiglare polarizer surface
- NL3224AC35-13: Smooth polarizer surface

FEATURES

- High luminance
- NTSC/PAL mode
- Reversible horizontal and vertical scanning
- 234/240 line display
- Wide temperature range
- Analog RGB interface
- Incorporated edge type backlight

APPLICATIONS

- Car navigations
- TV monitors
- Video games
- Monitors for process controller



The information in this document is subject to change without notice.
Please confirm with the delivery specification before starting to design the system.

STRUCTURE AND FUNCTIONS

A TFT color LCD module comprised a TFT LCD panel, LSIs for driving liquid crystal, and a backlight. The TFT LCD panel is composed of a TFT array glass substrate superimposed on a color filter glass substrate with liquid crystal filled in the narrow gap between two substrates. The backlight apparatus is located on the backside of the LCD panel.

RGB (Red, Green, Blue) data signals are sent to LCD panel drivers after modulation into suitable forms for active matrix addressing through signal processor.

Each of the liquid crystal cells acts as an electro-optical switch that controls the light transmission from the backlight by a signal applied to a signal electrode through the TFT switch.

OUTLINE OF CHARACTERISTICS (at room temperature)

| Items | Description |
|---|---|
| Display area | 111.36 (H) × 83.52 (V) mm |
| Drive system | a-Si TFT active matrix |
| Display colors | Full-color |
| Number of pixels | 320 × 240 |
| Pixel arrangement | RGB vertical stripe |
| Pixel pitch | 0.348 (H) × 0.348 (V) mm |
| Module size | 134.0 (H) × 110.0 (V) × 23.0 max. (D) mm |
| Weight | 315 g (typ.) |
| Contrast ratio | 85:1 (typ.) |
| Viewing angle (more than the contrast ratio of 10:1) | <ul style="list-style-type: none"> • Horizontal: 45° (typ. left side, right side) • Vertical: 30° (typ. up side), 15° (typ. down side) |
| Designed viewing direction | <ul style="list-style-type: none"> • wider viewing angle with contrast ratio : up side (12 o'clock) • wider viewing angle without image reversal : down side (6 o'clock) • optimum grayscale ($\gamma = 2.2$) : perpendicular |
| Color gamut | 50 % (typ. center, to NTSC) |
| Response time | 16 ms (typ.), "white" to "black" |
| Luminance | 250 cd/m ² (typ.) |
| Signal system | Analog RGB signals, synchronous signals (CLK, HS, VS) |
| Backlight | Edge light type, one fluorescent lamp (cold cathode type) Back-Light Unit. (Parts No.: 55LHS-1) |
| Supply voltage | 9.5 V (LCD power supply), 9.5 V (Backlight power supply) |
| Power consumption | 6.6 W (typ.) |

BLOCK DIAGRAM OF BASIC STRUCTURE

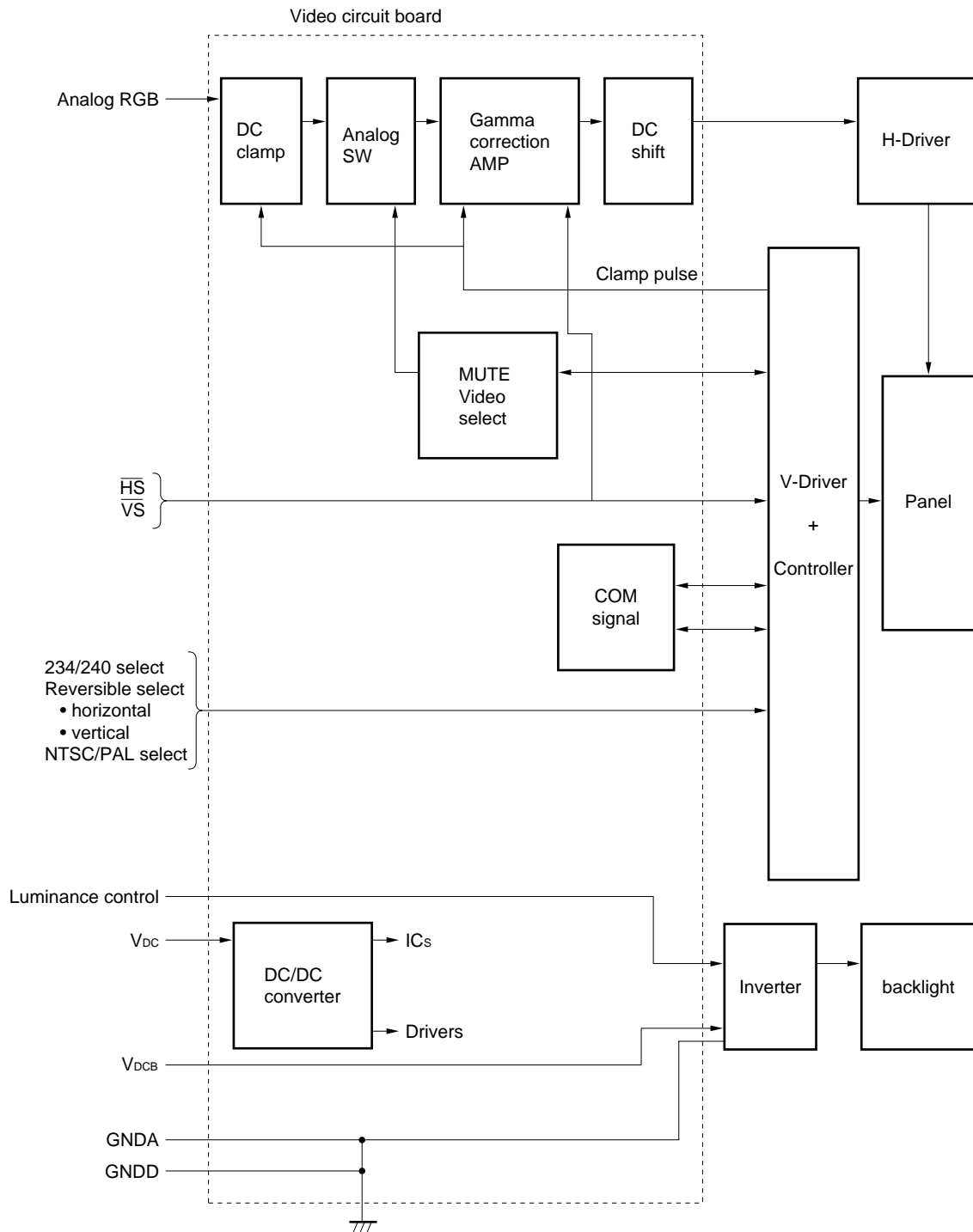

Note 1. Frame is contacted with both GND and GND

GENERAL SPECIFICATIONS

| Items | Description | Unit |
|-------------------|---|-------|
| Module size | 134.0 ± 0.5 (H) × 110.0 ± 0.5 (V) × 23.0 max. (D) | mm |
| Display area | 111.36 (H) × 83.52 (V) | mm |
| Number of dots | 320 × 3 (H) × 240 (V) | dot |
| Dot pitch | 0.116 (H) × 0.348 (V) | mm |
| Pixel pitch | 0.348 (H) × 0.348 (V) | mm |
| Pixel arrangement | RGB (Red, Green, Blue) vertical stripe | – |
| Display colors | Full-color | color |
| Weight | 330 (max.) | g |

Note An inverter is incorporated with the module.

ABSOLUTE MAXIMUM RATINGS

| Parameters | Symbols | Ratings | Unit | Remarks | |
|-------------------------|------------------|--|------------------|--|-----------------|
| Supply voltage | V _{DC} | –0.5 to 20.0 | V | T _a = 25°C | |
| | V _{DCB} | –0.5 to 20.0 | V | | |
| Analog RGB input signal | V _{IN1} | –2.5 to 2.5 | V | T _a = 25°C V _{DC} = 9.5 V | |
| Logic input voltage | V _{IN2} | –0.5 to 5.5 | V | | |
| Storage temp. | T _{ST} | –40 to 95 | °C | – | |
| Operating temp. | T _{OP} | –30 to 85 | °C | Note 1 | |
| Relative humidity (RH) | | ≤ 95 | % | T _a ≤ 40°C | no condensation |
| | | ≤ 85 | % | 40 < T _a ≤ 50°C | |
| Absolute humidity | | Absolute humidity shall not exceed T _a = 50°C, RH = 85% | g/m ³ | T _a > 50°C | |

Note 1. Module surface: measured at the display center.

ELECTRICAL CHARACTERISTICS

(1) Power supply, logic input

T_a = 25°C

| Parameters | Symbol | Min. | Typ. | Max. | Unit | Remarks |
|--------------------------|------------------|------|------|------|------|--|
| Supply voltage | V _{DC} | 8.0 | 9.5 | 13.0 | V | For processor, controller and driver |
| | V _{DCB} | 8.0 | 9.5 | 13.0 | V | For backlight |
| Logic input "L" voltage | V _{IL} | 0 | – | 0.9 | V | – |
| Logic input "H" voltage | V _{IH} | 3.15 | – | 5.0 | V | |
| Logic output "L" voltage | V _{OL} | 0 | – | 0.3 | V | |
| Logic output "H" voltage | V _{OH} | 4.5 | – | 5.0 | V | |
| Supply current | I _{DC} | – | 147 | 200 | mA | At dot-checked pattern (V _{DC} = 9.5 V) |
| | I _{DCB} | – | 541 | 600 | mA | Maximum luminance (V _{DCB} = 9.5 V) |

(2) Analog RGB signals

T_a = 25°C

| Parameters | Min. | Typ. | Max. | Unit | Remarks |
|--|------|------|------|------------------|-----------------------|
| Analog RGB input voltage (white - black) | 0 | – | 0.7 | V _{p-p} | Z _i = 75 Ω |
| DC input level (black level) | –1.0 | – | 1.0 | V | |

SUPPLY VOLTAGE SEQUENCE

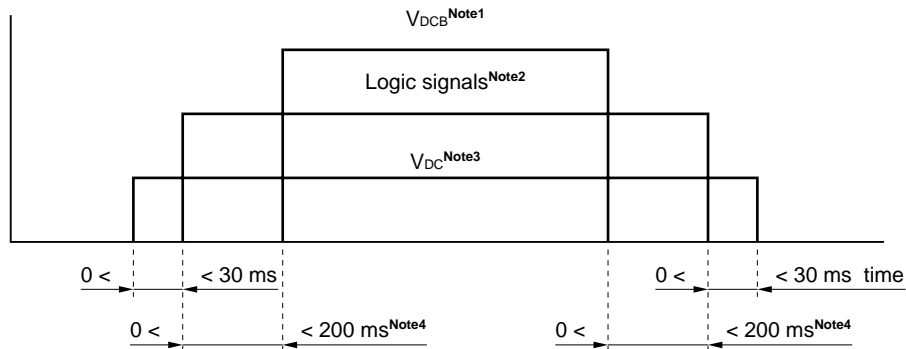

- Notes 1.** Apply V_{DCB} within the LCD operation period. When the backlight turns on before LCD operation or the LCD operation turns off before the backlight turns off, the display may momentarily become white.
- 2.** When the V_{DC} is off, please keep whole logic signals at "0 V." In case of the signal more than "0.3 V," internal circuit may get damaged.
- 3.** Please turn off V_{DC} when the signals are put off. If the signals are put off without keep V_{DC}, the display may be un-uniformity.
- 4.** Reference value.
- 5.** While the power is off, please keep whole signals (HS, VS, EXTCLK) at low level or high impedance.
- 6.** Wrong power sequence may damage to the module.

INTERFACE PIN CONFIGURATION

(1) Connector (CN1)

- Part no. : 52610-3090
- Supplier : Molex
- Adaptable cable : SUMI-CARD 1.0 mm pitch 30 wick 85°C quality
- Supplier : SUMITOMO ELECTRIC INDUSTRIES, LTD.

| Pin No. | Symbol | Pin No. | Symbol | Pin No. | Symbol |
|---------|----------------------|---------|------------------|---------|--------|
| 1 | GNDD | 11 | EXTCSL | 21 | GNDD |
| 2 | EXTCLK | 12 | GNDD | 22 | GNDD |
| 3 | GNDD | 13 | N/P | 23 | GNDD |
| 4 | \overline{HS} | 14 | MTSL | 24 | GNDA |
| 5 | \overline{VS} | 15 | $\overline{U/D}$ | 25 | R |
| 6 | $\overline{H_{OUT}}$ | 16 | R/L | 26 | GNDA |
| 7 | $\overline{V_{OUT}}$ | 17 | GNDD | 27 | G |
| 8 | B _{PLS} | 18 | V _{DCB} | 28 | GNDA |
| 9 | GNDD | 19 | V _{DCB} | 29 | B |
| 10 | GNDD | 20 | V _{DC} | 30 | GNDA |

<Connector location>

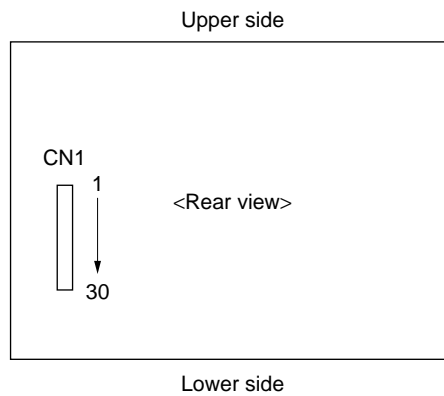

PIN DESCRIPTION

| Symbols | In/Out | Logics | Description |
|-------------------|-------------------|----------|---|
| EXTCLK | In Note 1 | – | External clock EXTCLK becomes active, when EXTCSL is “H” |
| EXTCSL | In Note 1 | Positive | Clock select signal Default value is L H: External clock L: Internal clock |
| \overline{HS} | In Note 1 | Negative | Horizontal synchronous signal |
| \overline{VS} | In Note 1 | Negative | Vertical synchronous signal |
| \overline{HOUT} | Out Note 1 | Negative | Horizontal synchronous signal output |
| \overline{VOUT} | Out Note 1 | Negative | Vertical synchronous signal output |
| R | In | – | Analog Red signal 0.7 Vp-p Zi = 75 Ω |
| G | In | – | Analog Green signal 0.7 Vp-p Zi = 75 Ω |
| B | In | – | Analog Blue signal 0.7 Vp-p Zi = 75 Ω |
| R/L | In Note 1 | – | Horizontal scanning select signal Default value is L H: Right scanning L: Left scanning |
| U/D | In Note 1 | – | Vertical scanning select signal Default value is L H: down scanning L: up scanning |
| N/P | In Note 1 | – | Display mode select Default value is L H: PAL mode L: NTSC mode |
| MTSL | In Note 1 | – | Vertical display area select signal Default value is L H: 240 lines L: 234 lines |
| B _{PLS} | In Note 1 | – | Luminance control signal (pulse input) Luminance is controlled by the pulse width. Duty 100%: luminance Max. Refer to P17 (note 8). |
| V _{DC} | In | – | Power supply for processor, controller and driver (+9.5 V) |
| V _{DCB} | In | – | Power supply for backlight (+9.5 V) |
| GNDA | – Note 2 | – | Ground for analog RGB signal |
| GNDD | – Note 2 | – | Ground for logic (V _{DC}) and backlight (V _{DCB}) |

Notes 1. CMOS level

2. GNDA should be separated from GNDD to avoid display noise.

SIGNALS

| No. | Functions | Description |
|-----|--------------------------------|--|
| 1 | Reversible horizontal scanning | $\overline{R/L}$ signal is able to reverse scanning direction. (Right → Left or Left → Right) |
| 2 | Reversible vertical scanning | $\overline{U/D}$ signal is able to reverse scanning direction. (Up → Down or Down → Up) |
| 3 | NTSC/PAL mode | $\overline{N/P}$ signal is able to change operating mode. (NTSC → PAL or PAL → NTSC) Scanning line is thinned out at the rate of seven to six lines in the PAL mode. |
| 4 | 234/240 line display | MTSL signal is able to change scanning line. (234 lines → 240 lines or 240 lines → 234 lines) |

INPUT SIGNAL TIMING

(1) mode

(a) NTSC, internal CLK

| Parameters | | Symbols | Min. | Typ. | Max. | Unit | Remarks |
|-------------------------------------|----------------------------|---------|--------|--------|-------|---------------|------------|
| Internal-CLK | Frequency | 1/tc | – | 6.36 | – | MHz | – |
| | | | – | 157.32 | – | ns | – |
| | Rise/fall | tcrf | – | – | 70 | ns | – |
| | Duty | tch/tc | 0.4 | 0.5 | 0.6 | – | – |
| $\overline{\text{HS}}$ | Frequency | th | 60.38 | 63.56 | 66.74 | μs | 15.734 kHz |
| | | | – | 404 | – | CLK | (typ.) |
| | Display | thd | – | 50.34 | – | μs | – |
| | | | – | 320 | – | CLK | – |
| | Pulse-width | thp | 1.0 | 4.7 | – | μs | – |
| | | | – | 30 | – | CLK | – |
| | Pulse-width +back-porch | thpb | – | 11.01 | – | μs | 234 line |
| | | | – | 70 | – | CLK | – |
| | | – | – | 12.11 | – | μs | 240 line |
| | | | – | 77 | – | CLK | – |
| CLK-Hsync timing hold/setup time | thch | 10.0 | – | – | ns | – | |
| | thcs | 10.0 | – | – | ns | – | |
| V-Hsync timing hold/setup time | thvh | 1 | – | – | CLK | – | |
| | thvs | 10.0 | – | – | ns | – | |
| Rise/fall | thrf | – | – | 10.0 | ns | – | |
| $\overline{\text{VS}}$ | Frequency | tv | 15.85 | 16.68 | 17.51 | ms | 59.94 Hz |
| | | | – | 262.5 | – | H | (typ.) |
| | Display | tvd | – | 14.87 | – | ms | 234 line |
| | | | – | 234 | – | H | – |
| | | – | – | 15.25 | – | ms | 240 line |
| | | | – | 240 | – | H | – |
| | Pulse-width | tvtp | 158.89 | 190.67 | – | μs | – |
| | | – | 3 | – | H | – | |
| Pulse-width +back-porch | tvtpb | – | 1.33 | – | ms | – | |
| | | – | 21 | – | H | – | |
| Rise/fall | tvrf | – | – | 10.0 | ns | – | |

Note In the display start period (pulse-width + back-porch), analog RGB signals should be blanking level.

(b) PAL, internal CLK

| Parameters | | Symbols | Min. | Typ. | Max. | Unit | Remarks |
|-----------------------------------|-------------------------------------|---------|--------|--------|-------|----------|------------|
| Internal-CLK | Frequency | 1/tc | – | 6.45 | – | MHz | – |
| | | | – | 154.96 | – | ns | – |
| | Rise/fall | tcrf | – | – | 70 | ns | – |
| | Duty | tch/tc | 0.4 | 0.5 | 0.6 | – | – |
| \overline{HS} | Frequency | th | 60.80 | 64.00 | 67.20 | μ s | 15.625 kHz |
| | | | – | 413 | – | CLK | (typ.) |
| | Display | thd | – | 49.60 | – | μ s | – |
| | | | – | 320 | – | CLK | – |
| | Pulse-width | thp | 1.0 | 4.7 | – | μ s | – |
| | | | – | 30 | – | CLK | – |
| | Pulse-width +back-porch | thpb | – | 11.93 | – | μ s | 234 line |
| | | | – | 77 | – | CLK | – |
| | | | – | 12.71 | – | μ s | 240 line |
| | CLK-Hsync timing hold/setup time | thch | 10.0 | – | – | ns | – |
| thcs | | | 10.0 | – | – | ns | – |
| V-Hsync timing hold/setup time | thvh | 1 | – | – | CLK | – | |
| | | thvs | 10.0 | – | – | ns | – |
| Rise/fall | thrf | – | – | 10.0 | ns | – | |
| \overline{VS} | Frequency | tv | 19.00 | 20.00 | 21.00 | ms | 50.00 Hz |
| | | | – | 312.5 | – | H | (typ.) |
| | Display | tvd | – | 17.47 | – | ms | 234 line |
| | | | – | 273 | – | H | – |
| | | | – | 17.92 | – | ms | 240 line |
| | | | – | 280 | – | H | – |
| | Pulse-width | tvp | 153.60 | 192.00 | – | μ s | – |
| | | | – | 2.5 | – | H | – |
| Pulse-width +back-porch | tvpb | – | 1.86 | – | ms | 234 line | |
| | | – | 29 | – | H | – | |
| | | – | 1.66 | – | ms | 240 line | |
| | | | – | 26 | – | H | – |
| | | | | | | | |
| Rise/fall | tvrf | – | – | 10.0 | ns | – | |

Note In the display start period (pulse-width + back-porch), analog RGB signals should be blanking level.

(c) NTSC, external CLK

| Parameters | | Symbols | Min. | Typ. | Max. | Unit | Remarks |
|-------------------|-------------------------------------|---------|-------------|----------------|-------------|----------------|----------------------|
| EXTCLK | Frequency | 1/tc | – 118.75 | 8.0 125.00 | – 131.25 | MHz ns | – |
| | Rise/fall | tcrf | – | – | 10 | ns | – |
| | Duty | tch/tc | 0.4 | 0.5 | 0.6 | – | – |
| \overline{HS} | Frequency | th | 60.38 – | 63.56 508 | 66.74 – | μ s CLK | 15.734 kHz (typ.) |
| | Display | thd | – – | 40.00 320 | – – | μ s CLK | – |
| | Pulse-width | thp | 1.0 – | 4.7 38 | – – | μ s CLK | – |
| | Pulse-width +back-porch | thpb | – – | 8.75 70 | – – | μ s CLK | 234 line |
| | | | – – | 9.63 77 | – – | μ s CLK | 240 line |
| | CLK-Hsync timing hold/setup time | thch | 10.0 | – | – | ns | – |
| | | thcs | 10.0 | – | – | ns | – |
| | V-Hsync timing hold/setup time | thvh | 1 | – | – | CLK | – |
| | | thvs | 10.0 | – | – | ns | – |
| Rise/fall | thrf | – | – | 10.0 | ns | – | |
| \overline{VS} | Frequency | tv | 15.85 – | 16.68 262.5 | 17.51 – | ms H | 59.94 Hz (typ.) |
| | Display | tvd | – – | 14.87 234 | – – | ms H | 234 line |
| | | | – – | 15.25 240 | – – | ms H | 240 line |
| | | | – – | – – | – – | – – | – – |
| | Pulse-width | tvp | 158.89 – | 190.67 3 | – – | μ s H | – |
| | Pulse-width +back-porch | tvpb | – – | 1.33 21 | – – | ms H | – |
| Rise/fall | tvrf | – | – | 10.0 | ns | – | |
| Analog R, G, B | Setup time | tdas | 10.0 | – | – | ns | – |
| | Hold time | tdah | 10.0 | – | – | ns | – |

Note In the display start period (pulse-width + back-porch), analog RGB signals should be blanking level.

(d) PAL, external CLK

| Parameters | | Symbols | Min. | Typ. | Max. | Unit | Remarks | |
|-------------------|-------------------------------------|-----------------------------------|-------------------------------------|----------------|---------------|----------------|----------------------|----------------|
| EXTCLK | Frequency | 1/tc | – 118.75 | 8.0 125.00 | – 131.25 | MHz ns | – | |
| | | Rise/fall | tcrf | – | – | 10 | ns | – |
| | Duty | tch/tc | 0.4 | 0.5 | 0.6 | – | – | |
| \overline{HS} | Frequency | th | 60.80 – | 64.00 512 | 67.20 – | μ s CLK | 15.625 kHz (typ.) | |
| | | Display | thd | – – | 40.00 320 | – – | μ s CLK | – |
| | Pulse-width | thp | 1.0 – | 4.7 38 | – – | μ s CLK | – | |
| | | | Pulse-width +back-porch | thpb | – – | 9.63 77 | – – | μ s CLK |
| | Pulse-width +back-porch | thpb | – – | 10.25 82 | – – | μ s CLK | 240 line | |
| | | | CLK-Hsync timing hold/setup time | thch | 10.0 | – | – | ns |
| | CLK-Hsync timing hold/setup time | thcs | 10.0 | – | – | – | ns | – |
| | | V-Hsync timing hold/setup time | thvh | 1 | – | – | CLK | – |
| | V-Hsync timing hold/setup time | | thvs | 10.0 | – | – | ns | – |
| | | Rise/fall | thrf | – | – | 10.0 | ns | – |
| \overline{VS} | Frequency | tv | 19.00 – | 20.00 312.5 | 21.00 – | ms H | 50.00 Hz (typ.) | |
| | | Display | tv | – – | 17.47 273 | – – | ms H | 234 line |
| | Display | | tv | – – | 17.92 280 | – – | ms H | 240 line |
| | | Pulse-width | tvp | 153.60 – | 192.00 2.5 | – – | μ s H | – |
| | Pulse-width +back-porch | | | tvpb | – – | 1.86 29 | – – | ms H |
| | | Pulse-width +back-porch | tvpb | | – – | 1.66 26 | – – | ms H |
| | Rise/fall | | | tvrf | – | – | 10.0 | ns |
| Analog R, G, B | Setup time | tdas | 10.0 | – | – | ns | – | |
| | Hold time | tdah | 10.0 | – | – | ns | – | |

Note In the display start period (pulse-width + back-porch), analog RGB signals should be blanking level.

(2) DEFINITION OF INPUT SIGNAL TIMING

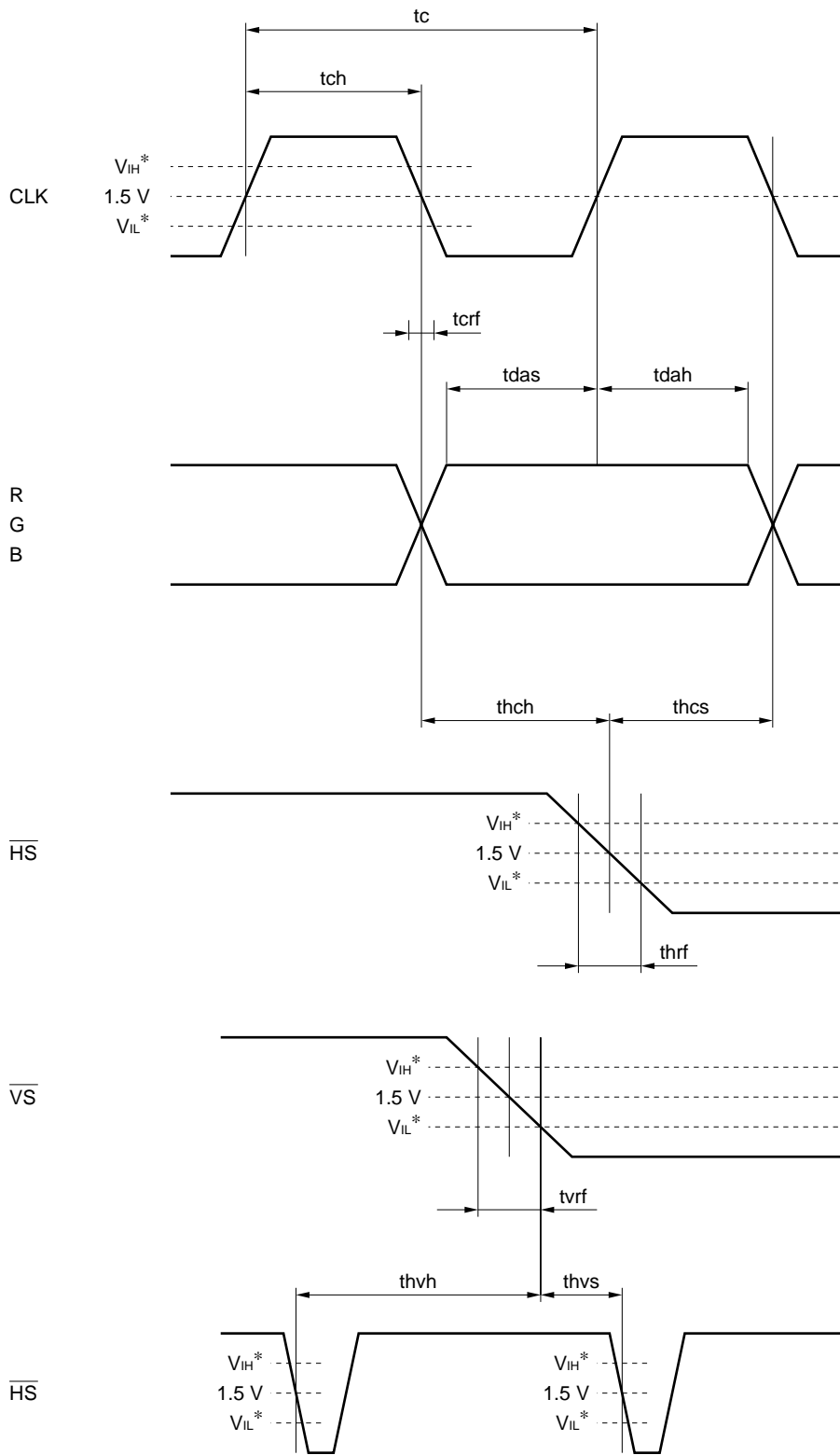

* $V_{IH} = 3.15 \text{ V (min.) to } 5.00 \text{ V (max.)}$
 $V_{IL} = 0.00 \text{ V (min.) to } 0.90 \text{ V (max.)}$

<Vertical>

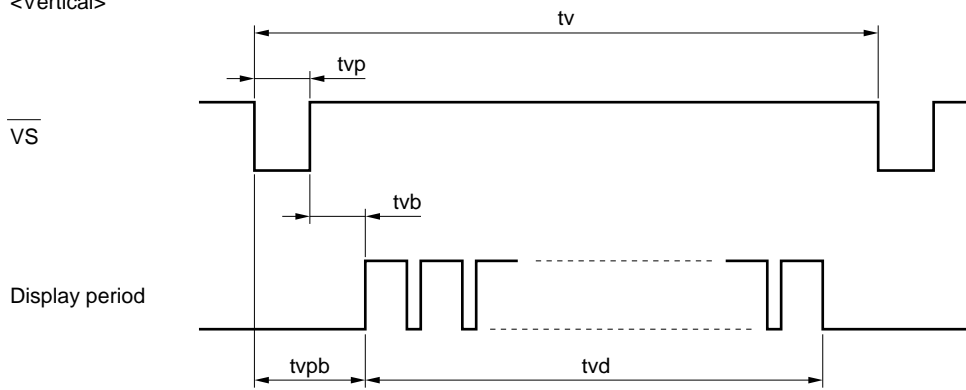

<Horizontal>

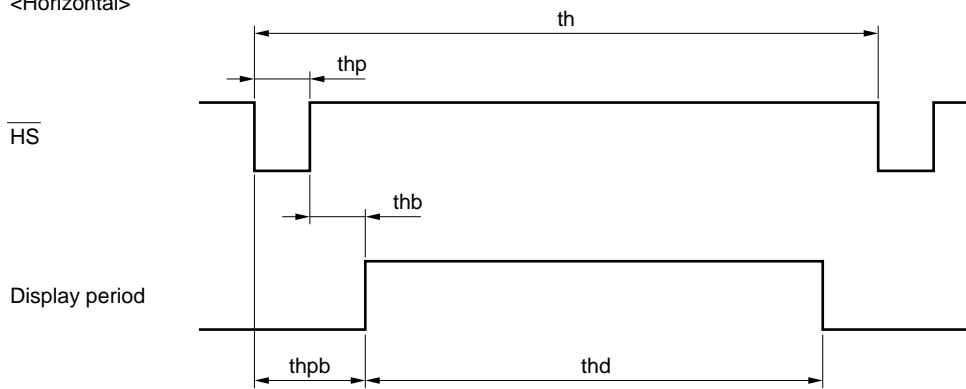

OPTICAL CHARACTERISTICS

($T_a = 25^\circ\text{C}$, $V_{DC} = 12\text{ V}$, $V_{DCB} = 12\text{ V}$) **Note 1**

| Item | Symbol | Condition | Min. | Typ. | Max. | Unit | Remark |
|----------------------|--------|---------------|------|------|------|-------------------|---------------|
| Contrast ratio | CR | Note 2 | 70 | 85 | – | – | Note 3 |
| Luminance | Lvmax | Note 2 | 200 | 250 | – | cd/m ² | Note 4 |
| Luminance uniformity | – | max./min. | – | – | 1.5 | – | Note 5 |

Reference data

($T_a = 25^\circ\text{C}$, $V_{DC} = 12\text{ V}$, $V_{DCB} = 12\text{ V}$)

| Item | Symbol | Condition | Min. | Typ. | Max. | Unit | Remark |
|-------------------------|---------------|---|------|------|------|------|---------------|
| Contrast ratio | CR | $\theta_x = \pm 0^\circ$, $\theta_y = -5^\circ$ | 80 | 100 | – | – | Note 3 |
| Viewing angle range | θ_{x+} | CR > 10, $\theta_y = -5^\circ$ white/black | 40 | 45 | 55 | deg. | Note 6 |
| | θ_{x-} | | 40 | 45 | 55 | deg. | |
| | θ_{y+} | CR > 10, $\theta_x = \pm 30^\circ$ white/black | 18 | 30 | 35 | deg. | |
| | θ_{y-} | | 10 | 15 | 25 | deg. | |
| Color gamut | C | $\theta_x = \pm 0^\circ$, $\theta_y = \pm 0^\circ$ to NTSC | 40 | 50 | – | % | – |
| Response time | Ton | white to black | – | 16 | 30 | ms | Note 7 |
| | Toff | black to white | – | 44 | 60 | ms | Note 7 |
| Luminance control range | – | max. = 100% | 10 | – | 100 | % | Note 8 |

Notes 1. $T_a = 25^\circ\text{C}$, $V_{DC} = 9.5\text{ V}$, $V_{DCB} = 9.5\text{ V}$

2. Viewing angle is $\theta_x = \pm 0^\circ$, $\theta_y = \pm 0^\circ$. At center.

3. The contrast ratio is calculated by using the following formula.

$$\text{Contrast ratio (CR)} = \frac{\text{Luminance with all pixels in "white"}}{\text{Luminance with all pixels in "black"}}$$

The luminance is measured in a darkroom.

4. The luminance is measured after 20 minutes from the module works, with all pixels in "white". The typical value is measured after luminance saturation.

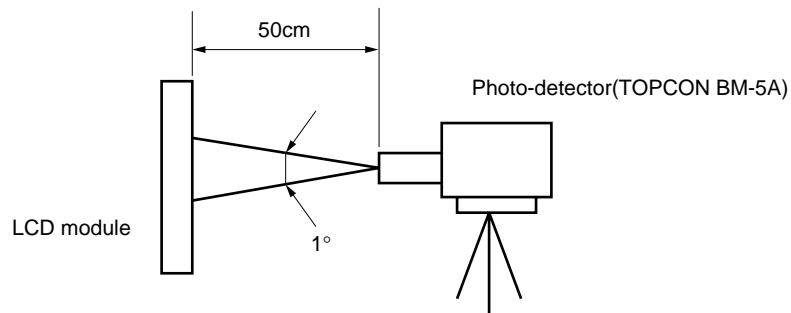

Notes 5. The measurement-point of Brightness (Luminance) uniformity.

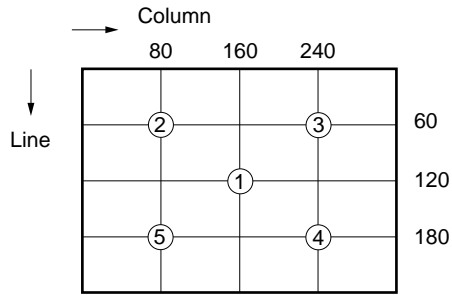

6. Definitions of viewing angle are as follows.

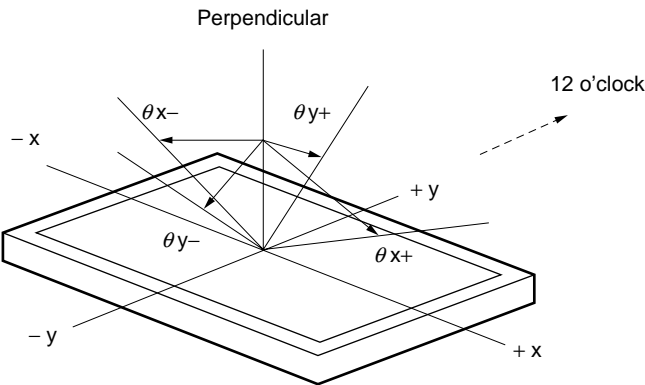

7. Definitions of response time is as follows.

Photo-detector output signal is measured when the luminance changes “white” to “black” and “black” to “white”. Response time are Ton and Toff of the photo-detector output amplitude. Ton is the time between 100% and 10%. Toff is the time between 0% and 90%.

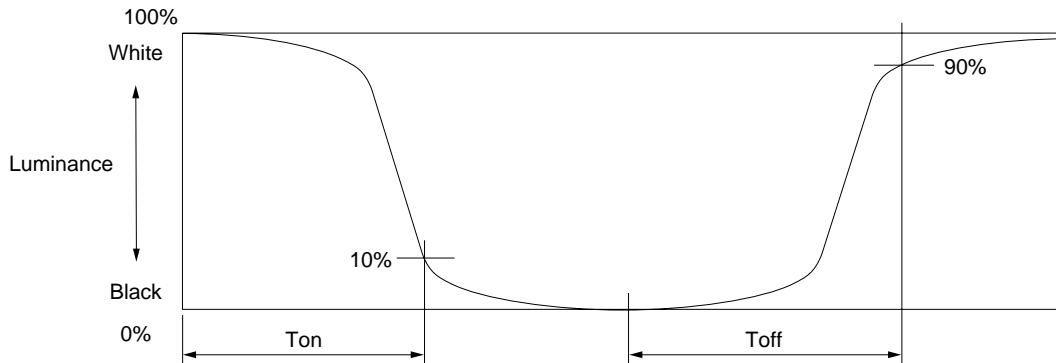

8. The pulse signal for luminous control needs to feed B_{PLS}-pin in the white-color data. (CMOS level)

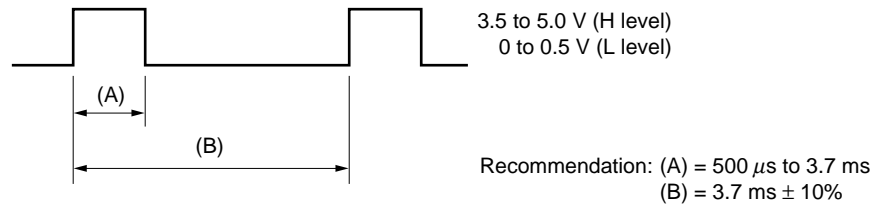

Pulse (A) duty 100%: Relative luminance is 100%

Pulse (A) duty 20%: Relative luminance is 10% (reference value)

The luminance control function works more than 10°C

Luminance control returns default (factory set) for the stability of the lamp operation when the LCD is less than 10°C.

RELIABILITY TEST SPECIFICATIONS

| No. | Test item | Test condition | Judgement |
|-----|---------------------------------------|--|--------------------------------|
| 1 | High temperature (operation) | <1> 85 ± 2°C at the display area <2> 192 heures <3> Others are based on JASO-D001-94. | Note 1 |
| 2 | Low temperature (operation) | <1> -30°C ± 4°C at the display area <2> 192 heures <3> Others are based on JASO-D001-94. | Note 1 |
| 3 | High temperature (non-operation) | <1> 95°C ± 2°C <2> 192 heures <3> Others are based on JASO-D001-94. | Note 1 |
| 4 | Low temperature (non-operation) | <1> -40°C ± 4°C <2> 192 heures <3> Others are based on JASO-D001-94. | Note 1 |
| 5 | High temperature/Humidity (operation) | <1> 60°C ± 2°C, 90% relative humidity <2> 192 heures <3> Others are based on JASO-D001-94. | Note 1 |
| 6 | Heat - Humidity cycle (operation) | <1> First step : 23 ± 2°C, 65% relative humidity, 4 hours Second step : 55 ± 2°C, 97% relative humidity, 10 hours Third step : -40 ± 4°C, 2 hours no-humidity arrangement Fourth step : 85 ± 2°C, 2 hours no-humidity arrangement <2> 10 cycles, 24 hours/cycle (Note 2) <3> Others are based on JASO-D001-94. | Note 1 |
| 7 | Heat cycle (operation) | <1> First step : 75 ± 2°C, 2 hours Second step : -30 ± 4°C, 2 hours <2> 35 cycles, 8 hours/cycle (Note 3) <3> Others are based on JASO-D001-94. | Note 1 |
| 8 | Thermal shock (non-operation) | <1> First step : 95 ± 2°C, 2 hours Second step : -40 ± 4°C, 2 hours 1 cycle <2> 50 cycles <3> Others are based on JASO-D001. | Note 1 |
| 9 | Vibration (non-operation) | <1> 5 to 200 Hz, 29.4 m/s ² (3G) <2> 10 min/sweep <3> X and Y direction : 2 hours Z direction : 4 hours <4> Others are based on JASO-D001. | Note 1 Note 4 |

JASO: Japanese Automobile Standards Organization

| No. | Test item | Test condition | Judgement |
|-----|----------------------------------|---|--------------------------------|
| 10 | Mechanical shock (non-operation) | <1> 980 m/s ² (100G), 11ms <2> X, Y and Z direction: 3 times each direction <3> Others are based on JASO-D001. | Note 1 |
| 11 | ESD (operation) | <1> 150 pF, 150 Ω, ± 10 KV <2> 9 points on a panel <3> 10 times/point, at an interval of 1 second | Note 1 Note 4 |
| 12 | Dust (operation) | <1> 15 kinds of dust (JIS-Z 8901) <2> 15 s/stir, 8 times | Note 1 |

JIS: Japanese Industrial Standards

- Notes**
1. Display function is checked by the same condition of the out-going inspection.
 2. Refer to Heat/Humidity cycle pattern (See the next page).
 3. Refer to heat cycle pattern (See the next page).
 4. Discharge points are shown as follow.

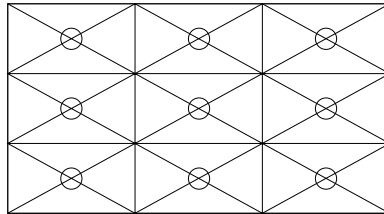

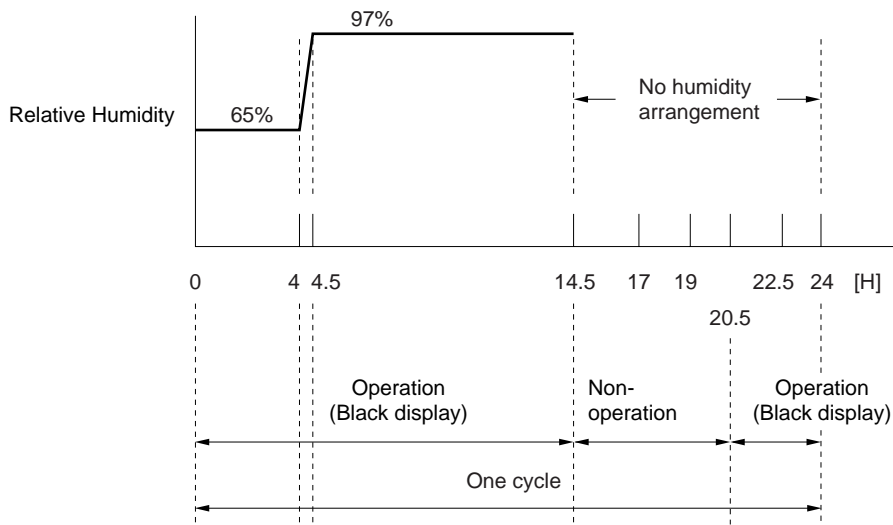
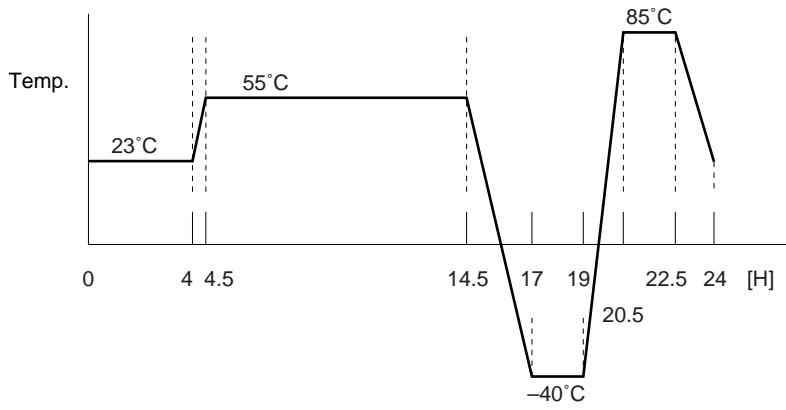

Note 2 Heat/Humidity cycle pattern

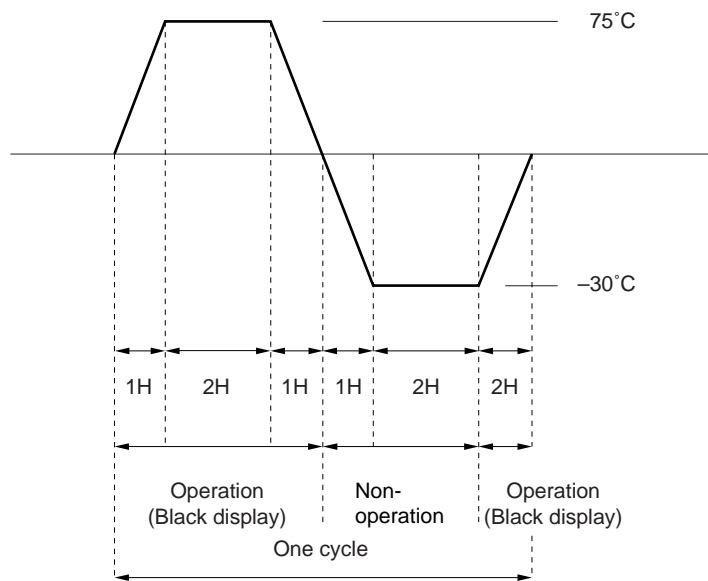



Note 3 Heat cycle pattern

GENERAL CAUTIONS

Next figures and sentence are very important, Please understand these contents as follows.

| | | |
|---|----------------|--|
|  | CAUTION | This figure is a mark that you will get hurt and/or the module will have damages when you make a mistake to operate. |
|---|----------------|--|

| | |
|---|---|
|  | This figure is a mark that you will get an electric shock when you make a mistake to operate. |
|  | This figure is a mark that you will get hurt when you make a mistake to operate |

 **CAUTION**

| | |
|---|--|
|  | Do not touch an inverter, on which is stuck a caution label... while the LCD module is under the operation, because of dangerous high voltage. |
|---|--|

- (1) Caution when taking out the module
 - a) Pick the pouch only, when taking out the module from a slipping box.

- (2) Cautions for handling the module
 - a) As the electrostatic discharges may break the LCD module, handle the LCD module with care against electrostatic discharges.
 - b)  As the LCD panel and backlight element are made from fragile glass material, impulse and pressure to the LCD module should be avoided.
 - c) As the surface of polarizer is very soft and easily scratched, use a soft dry cloth without chemicals for cleaning.
 - d) Do not pull the interface connectors in or out while the LCD module is operating.
 - e) Put the module display side down on a flat horizontal plane.
 - f) Handle connectors and cables with care.
 - g) When the module is operating, do not lose EXTCLK, HS, or VS signal. If any one of these signals is lost, the LCD panel would be damaged.

- (3) Cautions for the atmosphere
 - a) Dew drop atmosphere should be avoided.
 - b) Do not store and/or operate the LCD module in a high temperature and/or high humidity atmosphere. Storage in an Electro-conductive Polymer Packing Pouch and under relatively low temperature atmosphere is recommended.
 - c) This module uses a cold cathod fluorescent lamp. Therefore, the life time of the lamp becomes short conspicuously at low temperature.
 - d) Do not operate the LCD module in high magnetic field.

- (4) Caution for the module characteristics
 - a) Do not apply the fixed patterns data signal to the LCD module at product aging. In order to avoid image sticking, do not display with fixed pattern. Periodic change of display pattern is recommended.

(5) Other cautions

- a) Do not disassemble and/or reassemble LCD module.
- b) Do not readjust variable resistors nor switches, etc.
- c) When returning the module for repair etc., pack the module not to be broken. We recommend the original shipping packages.

Liquid Crystal Display has the following specific characteristics. There are not defects or malfunctions.

The display condition of the LCD module may be affected by the ambient temperature.

The module has cold cathode tube for backlighting. Optical characteristics, like luminance or uniformity, will change during time.

Uneven brightness and/or small spots may be noticed depending on different display patterns.

OUTLINE DRAWING (Unit in mm) Front view

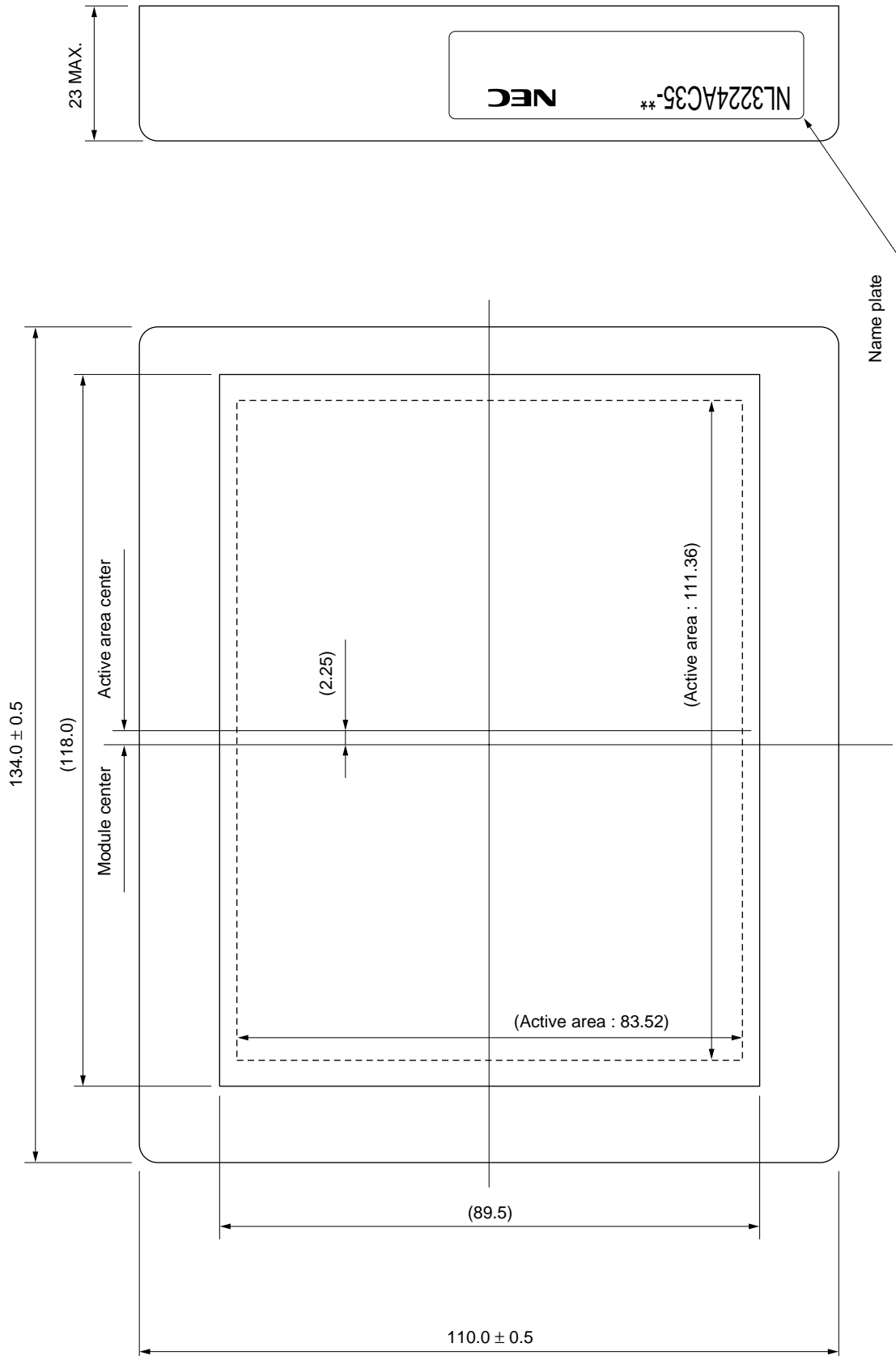

OUTLINE DRAWING (Unit in mm) Rear view

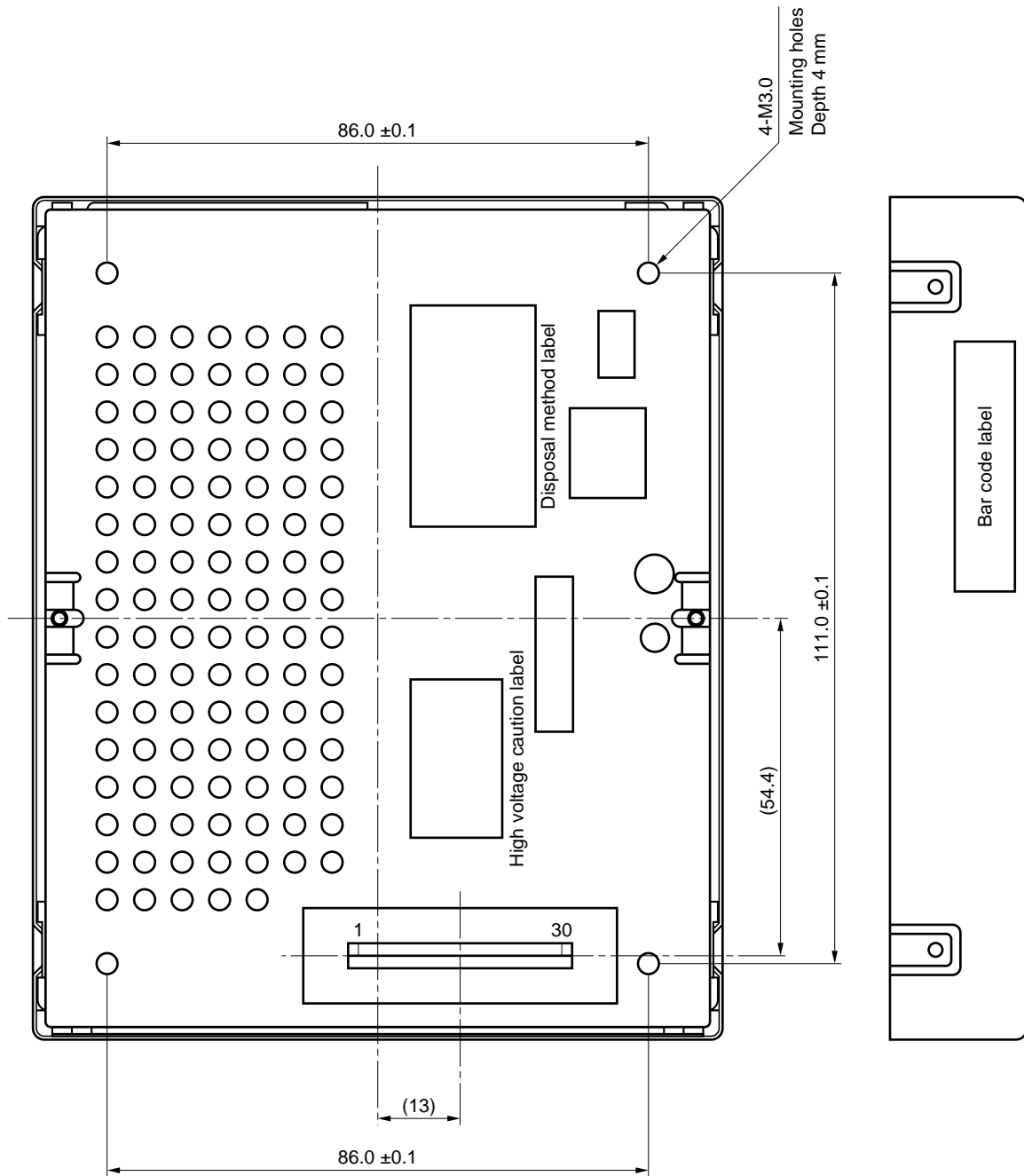

No part of this document may be copied or reproduced in any form or by any means without the prior written consent of NEC Corporation. NEC Corporation assumes no responsibility for any errors which may appear in this document.

NEC Corporation does not assume any liability for infringement of patents. Copyrights or other intellectual property rights of third parties by or arising from use of a device described herein or any other liability arising from use of such device. No license, either express, implied or otherwise, is granted under any patents, copyrights or other intellectual property rights of NEC Corporation or of others.

While NEC Corporation has been making continuous effort to enhance the reliability of its Electronic Components, the possibility of defects cannot be eliminated entirely. To minimize risks of damage or injury to persons or property arising from a defect in an NEC Electronic Components, customers must incorporate sufficient safety measures in its design, such as redundancy, fire-containment, and anti-failure features.

NEC devices are classified into the following three quantity grades:

"Standard", "Special", and "Specific". The Specific quantity grade applies only to devices developed based on a customer designated "quality assurance program" for a specific application. The recommended applications of a device depend on its quality grade, as indicated below. Customers must check the quality grade of each device before using it in a particular application.

Standard: Computers, office equipment, communications equipment, test and measurement equipment, audio and visual equipment, home electronic appliances, machine tools, personal electronic equipment and industrial robots.

Special: Transportation equipment (automobiles, trains, ships, etc.), traffic control systems, anti-disaster systems, anti-crime systems, safety equipment and medical equipment (not specifically designed for life support)

Specific: Aircrafts, aerospace equipment, submersible repeaters, nuclear reactor control systems, life support system or medical equipment for life support, etc.

The quality grade of NEC devices is "Standard" unless otherwise specified in NEC's Data Sheets or Data Books. If customers intend to use NEC devices for applications other than those specified for Standard quality grade, they should contact an NEC sales representative in advance.

Anti-radioactive design is not implemented in this product.