

# NLAS4684

## Ultra-Low Resistance Dual SPDT Analog Switch

The NLAS4684 is an advanced CMOS analog switch fabricated in Sub-micron silicon gate CMOS technology. The device is a dual Independent Single Pole Double Throw (SPDT) switch featuring Ultra-Low  $R_{ON}$  of 0.5  $\Omega$ , for the Normally Closed (NC) switch, and 0.8  $\Omega$  for the Normally Opened switch (NO) at 2.7 V.

The part also features guaranteed Break Before Make switching, assuring the switches never short the driver.

The NLAS4684 is available in a 2.0 x 1.5 mm bumped die array. The pitch of the solder bumps is 0.5 mm for easy handling.

### Features

- Ultra-Low  $R_{ON}$ , < 0.5  $\Omega$  at 2.7 V
- Threshold Adjusted to Function with 1.8 V Control at  $V_{CC} = 2.7-3.3$  V
- Single Supply Operation from 1.8-5.5 V
- Tiny 2 x 1.5 mm Bumped Die
- Low Crosstalk, < 83 dB at 100 kHz
- Full 0- $V_{CC}$  Signal Handling Capability
- High Isolation, -65 dB at 100 kHz
- Low Standby Current, < 50 nA
- Low Distortion, < 0.14% THD
- $R_{ON}$  Flatness of 0.15  $\Omega$
- Pin for Pin Replacement for MAX4684
- High Continuous Current Capability  
± 300 mA Through Each Switch
- Large Current Clamping Diodes at Analog Inputs  
± 300 mA Continuous Current Capability
- Pb-Free Package is Available\*

### Applications

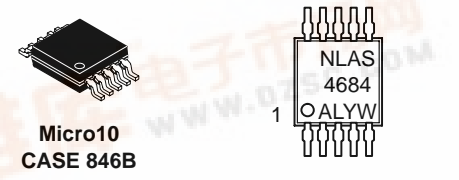
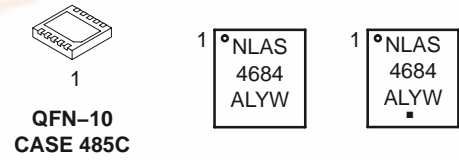
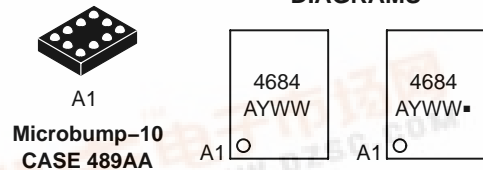
- Cell Phone
- Speaker Switching
- Power Switching
- Modems
- Automotive



ON Semiconductor®

<http://onsemi.com>

### MARKING DIAGRAMS



A = Assembly Location  
 L = Wafer Lot  
 Y = Year  
 WW, W = Work Week  
 ■ = Pb-Free Package

### FUNCTION TABLE

IN 1, 2	NO 1, 2	NC 1, 2
0	OFF	ON
1	ON	OFF

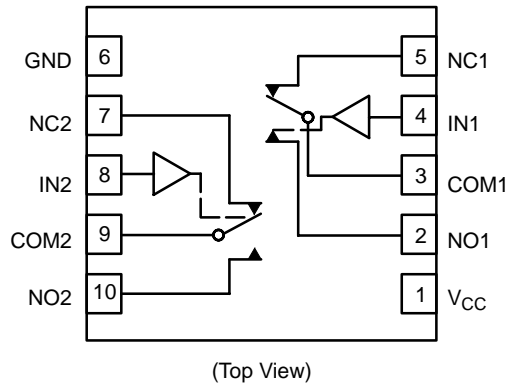
### ORDERING INFORMATION

See detailed ordering and shipping information in the package dimensions section on page 11 of this data sheet.

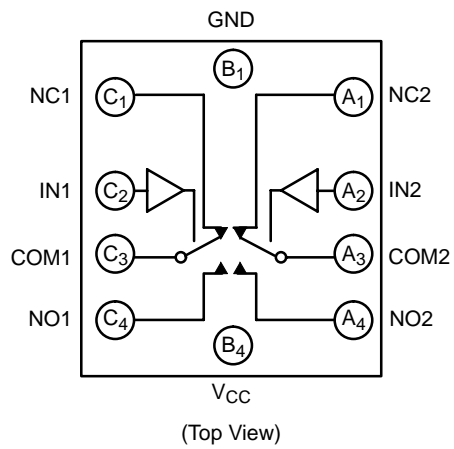
\*For additional information on our Pb-Free strategy and soldering details, please download the ON Semiconductor Soldering and Mounting Techniques Reference Manual, SOLDERRM/D.



# NLAS4684



**Figure 1. Pin Connections and Logic Diagram (QFN-10 and Micro10)**



**Figure 2. Pin Connections and Logic Diagram (Microbump-10)**

# NLAS4684

## MAXIMUM RATINGS

Symbol	Parameter	Value	Unit
V <sub>CC</sub>	Positive DC Supply Voltage	-0.5 to +7.0	V
V <sub>IS</sub>	Analog Input Voltage (V <sub>NO</sub> , V <sub>NC</sub> , or V <sub>COM</sub> )	-0.5 ≤ V <sub>IS</sub> ≤ V <sub>CC</sub> + 0.5	V
V <sub>IN</sub>	Digital Select Input Voltage	-0.5 ≤ V <sub>I</sub> ≤ +7.0	V
I <sub>anl1</sub>	Continuous DC Current from COM to NC/NO	±300	mA
I <sub>anl-pk 1</sub>	Peak Current from COM to NC/NO, 10 duty cycle (Note 1)	±500	mA
I <sub>clmp</sub>	Continuous DC Current into COM/NO/NC	±300	mA
I <sub>clmp 1</sub>	Peak Current into Input Clamp Diodes at COM/NC/NO	±500	mA

Maximum ratings are those values beyond which device damage can occur. Maximum ratings applied to the device are individual stress limit values (not normal operating conditions) and are not valid simultaneously. If these limits are exceeded, device functional operation is not implied, damage may occur and reliability may be affected.

1. Defined as 10% ON, 90% off duty cycle.

## RECOMMENDED OPERATING CONDITIONS

Symbol	Parameter	Min	Max	Unit
V <sub>CC</sub>	DC Supply Voltage	1.8	5.5	V
V <sub>IN</sub>	Digital Select Input Voltage	GND	5.5	V
V <sub>IS</sub>	Analog Input Voltage (NC, NO, COM)	GND	V <sub>CC</sub>	V
T <sub>A</sub>	Operating Temperature Range	-55	+125	°C
t <sub>r</sub> , t <sub>f</sub>	Input Rise or Fall Time, SELECT	V <sub>CC</sub> = 3.3 V ± 0.3 V V <sub>CC</sub> = 5.0 V ± 0.5 V	0 100 20	ns/V

## DC CHARACTERISTICS – Digital Section (Voltages Referenced to GND)

Symbol	Parameter	Condition	V <sub>CC</sub> ± 10%	Guaranteed Limit			Unit
				-55°C to 25°C	< 85°C	< 125°C	
V <sub>IH</sub>	Minimum High-Level Input Voltage, Select Inputs (Figure 10)		2.0	1.4	1.4	1.4	V
			2.5	1.4	1.4	1.4	
			3.0	1.4	1.4	1.4	
			5.0	2.0	2.0	2.0	
V <sub>IL</sub>	Maximum Low-Level Input Voltage, Select Inputs (Figure 10)		2.0	0.5	0.5	0.5	V
			2.5	0.5	0.5	0.5	
			3.0	0.5	0.5	0.5	
			5.0	0.8	0.8	0.8	
I <sub>IN</sub>	Maximum Input Leakage Current, Select Inputs	V <sub>IN</sub> = 5.5 V or GND	5.5	± 1.0	± 1.0	± 1.0	µA
I <sub>OFF</sub>	Power Off Leakage Current	V <sub>IN</sub> = 5.5 V or GND	0	± 10	± 10	± 10	µA
I <sub>CC</sub>	Maximum Quiescent Supply Current (Note 2)	Select and V <sub>IS</sub> = V <sub>CC</sub> or GND	5.5	± 50	± 200	± 200	nA

2. Guaranteed by design.

# NLAS4684

## DC ELECTRICAL CHARACTERISTICS – Analog Section

Symbol	Parameter	Condition	$V_{CC} \pm 10\%$	Guaranteed Maximum Limit						Unit
				-55°C to 25°C		< 85°C		< 125°C		
				Min	Max	Min	Max	Min	Max	
$R_{ON} (NC)$	NC "ON" Resistance (Note 3)	$V_{IN} \leq V_{IL}$ $V_{IS} = GND \text{ to } V_{CC}$ $ I_{IN}  \leq 100 \text{ mA}$	2.5		0.6		0.7		0.8	$\Omega$
			3.0		0.5		0.5		0.5	
			5.0		0.4		0.4		0.5	
$R_{ON} (NO)$	NO "ON" Resistance (Note 3)	$V_{IN} \geq V_{IH}$ $V_{IS} = GND \text{ to } V_{CC}$ $ I_{IN}  \leq 100 \text{ mA}$	2.5		2.0		2.0		2.0	$\Omega$
			3.0		0.8		0.8		1.0	
			5.0		0.8		0.8		0.9	
$R_{FLAT} (NC)$	NC_On-Resistance Flatness (Notes 3, 5)	$I_{COM} = 100 \text{ mA}$ $V_{IS} = 0 \text{ to } V_{CC}$	2.5		0.15		0.15		0.15	$\Omega$
			3.0		0.15		0.15		0.15	
			5.0		0.15		0.15		0.15	
$R_{FLAT} (NO)$	NO_On-Resistance Flatness (Notes 3, 5)	$I_{COM} = 100 \text{ mA}$ $V_{IS} = 0 \text{ to } V_{CC}$	2.5		0.35		0.35		0.35	$\Omega$
			3.0		0.35		0.35		0.35	
			5.0		0.35		0.35		0.35	
$\Delta R_{ON}$	On-Resistance Match Between Channels (Notes 3 and 4)	$V_{IS} = 1.3 \text{ V};$ $I_{COM} = 100 \text{ mA}$ $V_{IS} = 1.5 \text{ V};$ $I_{COM} = 100 \text{ mA}$ $V_{IS} = 2.8 \text{ V};$ $I_{COM} = 100 \text{ mA}$	2.5		0.18		0.18		0.18	$\Omega$
			3.0		0.06		0.06		0.06	
			5.0		0.06		0.06		0.06	
$I_{NC(OFF)}$ $I_{NO(OFF)}$	NC or NO Off Leakage Current (Figure 13) (Note 3)	$V_{IN} = V_{IL} \text{ or } V_{IH}$ $V_{NO} \text{ or } V_{NC} = 1.0$ $V_{COM} = 4.5 \text{ V}$	5.5	-1	1	-10	10	-100	100	nA
$I_{COM(ON)}$	COM ON Leakage Current (Figure 13) (Note 3)	$V_{IN} = V_{IL} \text{ or } V_{IH}$ $V_{NO} 1.0 \text{ V or } 4.5 \text{ V with}$ $V_{NC} \text{ floating or}$ $V_{NC} 1.0 \text{ V or } 4.5 \text{ V with}$ $V_{NO} \text{ floating}$ $V_{COM} = 1.0 \text{ V or } 4.5 \text{ V}$	5.5	-2	2	-20	20	-200	200	nA

3. Guaranteed by design. Resistance measurements do not include test circuit or package resistance.

4.  $\Delta R_{ON} = R_{ON(MAX)} - R_{ON(MIN)}$  between NC1 and NC2 or between NO1 and NO2.

5. Flatness is defined as the difference between the maximum and minimum value of on-resistance as measured over the specified analog signal ranges.

# NLAS4684

## AC ELECTRICAL CHARACTERISTICS (Input $t_r = t_f = 3.0$ ns) (Typical characteristics are at 25°C)

Symbol	Parameter	Test Conditions	V <sub>CC</sub> (V)	V <sub>IS</sub> (V)	Guaranteed Maximum Limit						Unit	
					-55°C to 25°C			< 85°C		< 125°C		
					Min	Typ	Max	Min	Max	Min		Max
t <sub>ON</sub>	Turn-On Time	R <sub>L</sub> = 50 Ω, C <sub>L</sub> = 35 pF (Figures 4 and 5)	2.5	1.3			60		70		70	ns
			3.0	1.5			50		60		60	
			5.0	2.8			30		35		35	
t <sub>OFF</sub>	Turn-Off Time	R <sub>L</sub> = 50 Ω, C <sub>L</sub> = 35 pF (Figures 4 and 5)	2.5	1.3			50		55		55	ns
			3.0	1.5			40		50		50	
			5.0	2.8			30		35		35	
t <sub>BBM</sub>	Minimum Break-Before-Make Time (Note 6)	V <sub>IS</sub> = 3.0 R <sub>L</sub> = 300 Ω, C <sub>L</sub> = 35 pF (Figure 3)	3.0	1.5	2	15						ns

		Typical @ 25, V <sub>CC</sub> = 5.0 V				pF
C <sub>NC Off</sub>	NC Off Capacitance, f = 1 MHz	102				
C <sub>NO Off</sub>	NO Off Capacitance, f = 1 MHz	104				
C <sub>NC On</sub>	NC On Capacitance, f = 1 MHz	322				
C <sub>NO On</sub>	NO On Capacitance, f = 1 MHz	330				

## ADDITIONAL APPLICATION CHARACTERISTICS (Voltages Referenced to GND Unless Noted)

Symbol	Parameter	Condition	V <sub>CC</sub> V	Typical	Unit	
				25°C		
BW	Maximum On-Channel -3dB Bandwidth or Minimum Frequency Response	V <sub>IN</sub> = 0 dBm V <sub>IN</sub> centered between V <sub>CC</sub> and GND (Figure 6)	NC	3.0	6.5	MHz
			NO	3.0	9.5	
V <sub>ONL</sub>	Maximum Feed-through On Loss	V <sub>IN</sub> = 0 dBm @ 100 kHz to 50 MHz V <sub>IN</sub> centered between V <sub>CC</sub> and GND (Figure 6)		3.0	-0.05	dB
V <sub>ISO</sub>	Off-Channel Isolation (Note 7)	f = 100 kHz; V <sub>IS</sub> = 1 V RMS; C <sub>L</sub> = 5 nF V <sub>IN</sub> centered between V <sub>CC</sub> and GND (Figure 6)		3.0	-65	dB
Q	Charge Injection Select Input to Common I/O (Figures 10 and 11)	V <sub>IN</sub> = V <sub>CC</sub> to GND, R <sub>IS</sub> = 0 Ω, C <sub>L</sub> = 1 nF Q = C <sub>L</sub> - ΔV <sub>OUT</sub> (Figure 7)		3.0	15	pC
THD	Total Harmonic Distortion THD + Noise (Figure 9)	F <sub>IS</sub> = 20 Hz to 100 kHz, R <sub>L</sub> = R <sub>gen</sub> = 600 Ω, C <sub>L</sub> = 50 pF V <sub>IS</sub> = 1 V RMS		3.0	0.14	%
VCT	Channel-to-Channel Crosstalk	f = 100 kHz; V <sub>IS</sub> = 1 V RMS, C <sub>L</sub> = 5 pF, R <sub>L</sub> = 50 Ω V <sub>IN</sub> centered between V <sub>CC</sub> and GND (Figure 6)		3.0	-83	dB

6. -55°C specifications are guaranteed by design.

7. Off-Channel Isolation = 20log<sub>10</sub> (V<sub>com</sub>/V<sub>no</sub>) (See Figure 6).

# NLAS4684

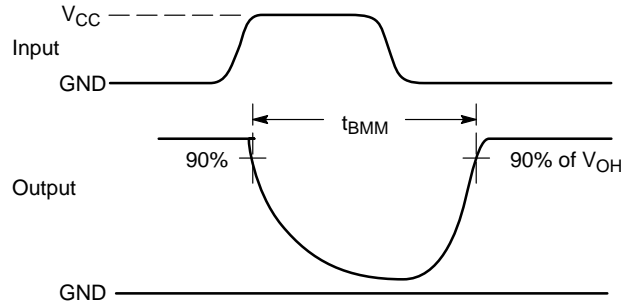
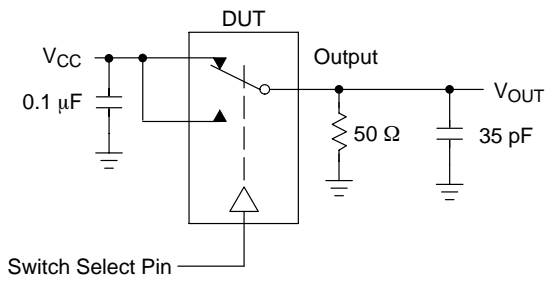


Figure 3.  $t_{BMM}$  (Time Break-Before-Make)

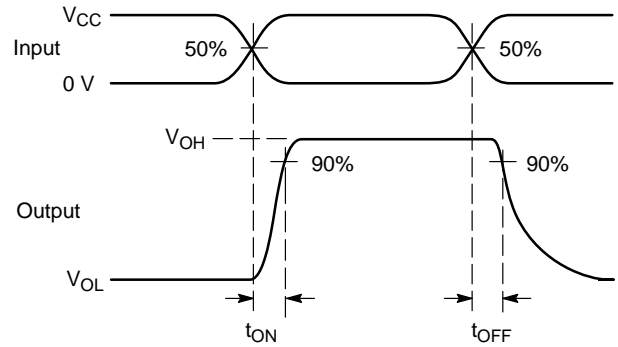
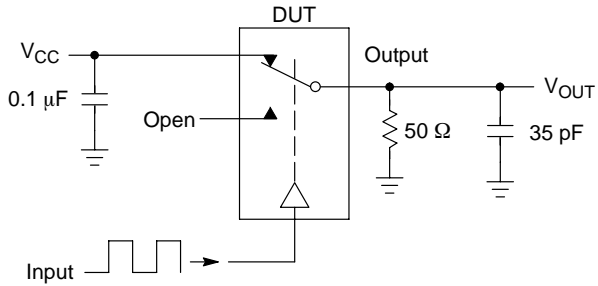


Figure 4.  $t_{ON}/t_{OFF}$

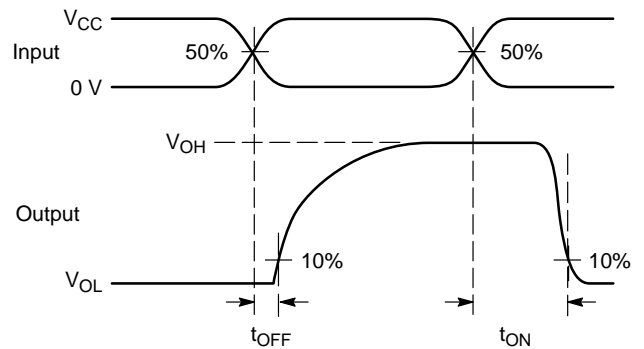
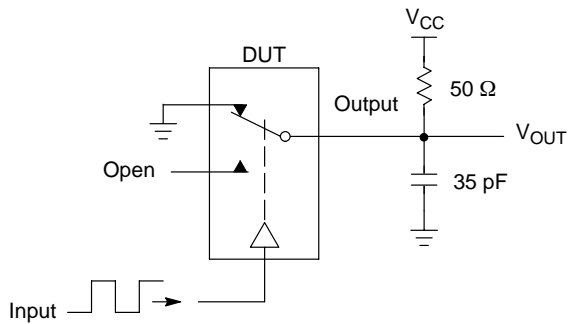
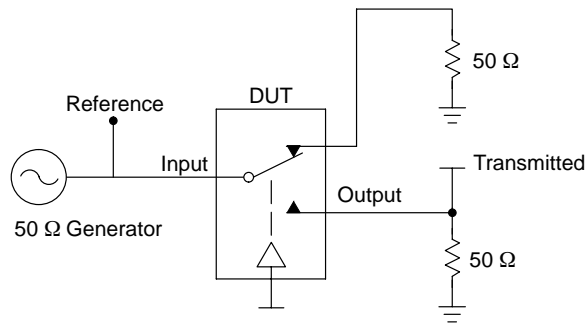


Figure 5.  $t_{ON}/t_{OFF}$

# NLAS4684



Channel switch control/s test socket is normalized. Off isolation is measured across an off channel. On loss is the bandwidth of an On switch.  $V_{ISO}$ , Bandwidth and  $V_{ONL}$  are independent of the input signal direction.

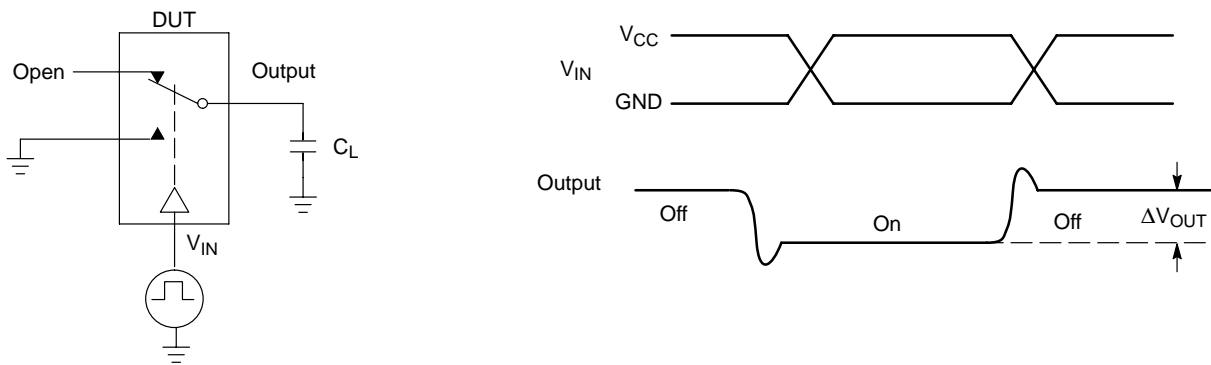
$$V_{ISO} = \text{Off Channel Isolation} = 20 \text{ Log} \left( \frac{V_{OUT}}{V_{IN}} \right) \text{ for } V_{IN} \text{ at } 100 \text{ kHz}$$

$$V_{ONL} = \text{On Channel Loss} = 20 \text{ Log} \left( \frac{V_{OUT}}{V_{IN}} \right) \text{ for } V_{IN} \text{ at } 100 \text{ kHz to } 50 \text{ MHz}$$

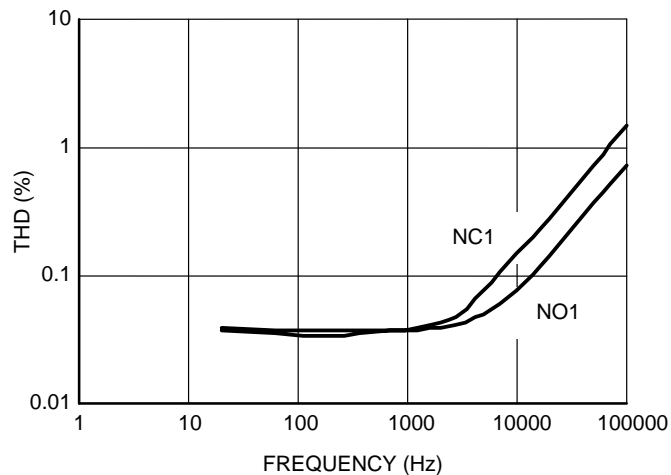
Bandwidth (BW) = the frequency 3 dB below  $V_{ONL}$

$V_{CT}$  = Use  $V_{ISO}$  setup and test to all other switch analog input/outputs terminated with 50  $\Omega$

**Figure 6. Off Channel Isolation/On Channel Loss (BW)/Crosstalk (On Channel to Off Channel)/ $V_{ONL}$**



**Figure 7. Charge Injection: (Q)**



**Figure 8. Total Harmonic Distortion Plus Noise Versus Frequency**

# NLAS4684

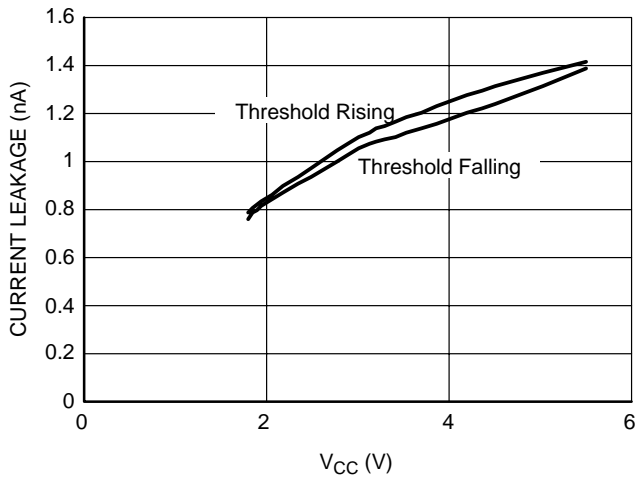


Figure 9. Voltage in Threshold on Logic Pins

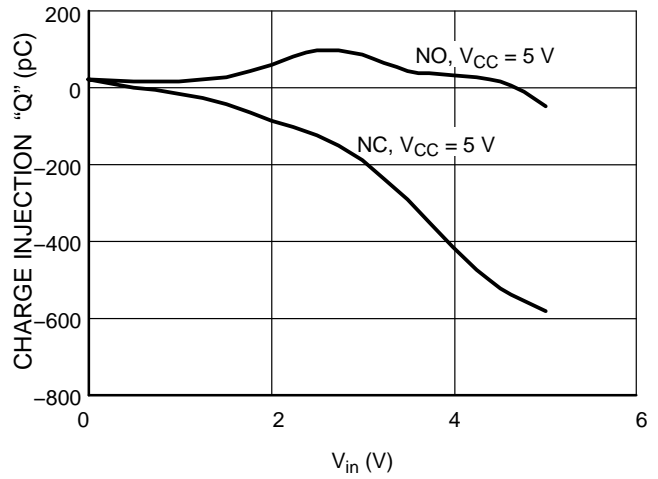


Figure 10. Charge Injection versus  $V_{IS}$

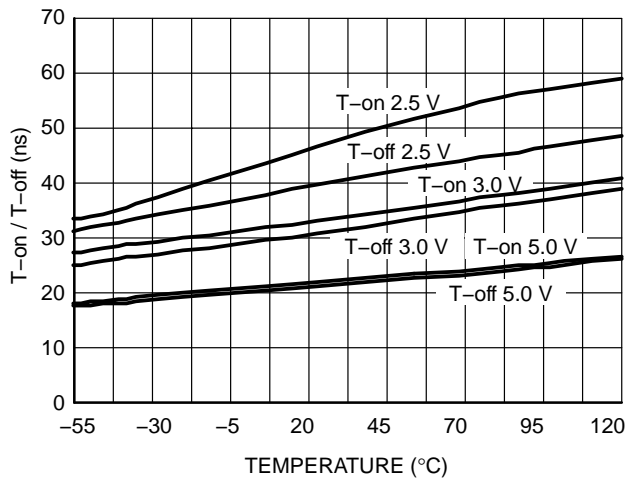


Figure 11. T-on / T-off Time versus Temperature

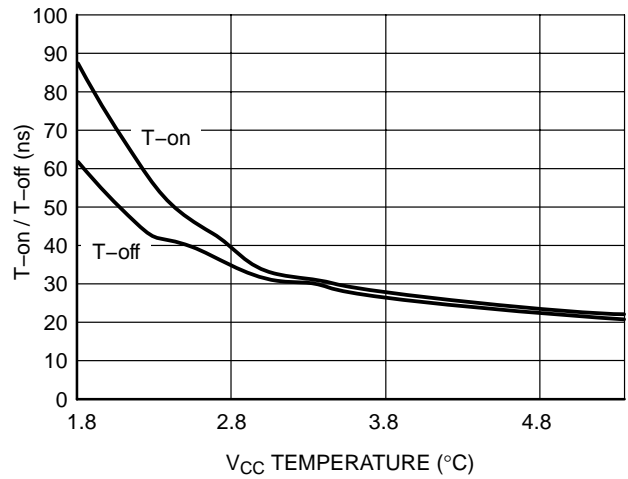


Figure 12. T-on / T-off Time versus Temperature

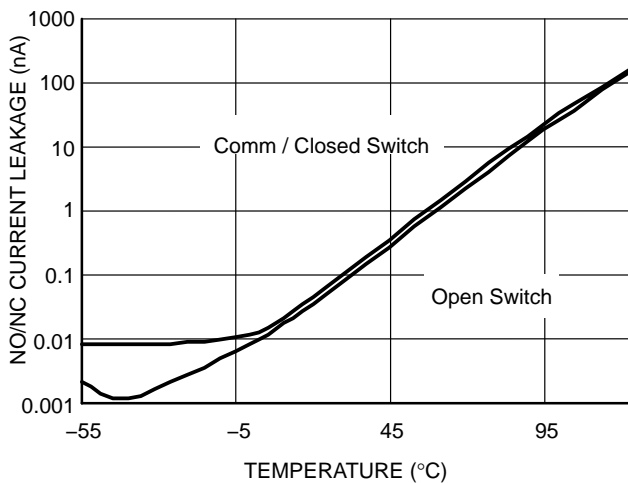


Figure 13. NO/NC Current Leakage Off and On,  $V_{CC} = 5 V$

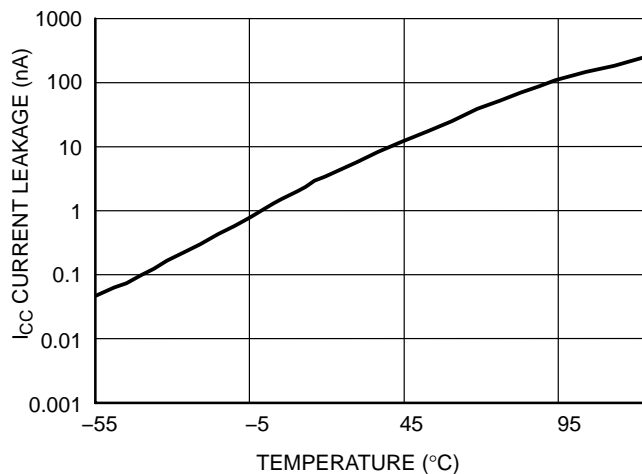
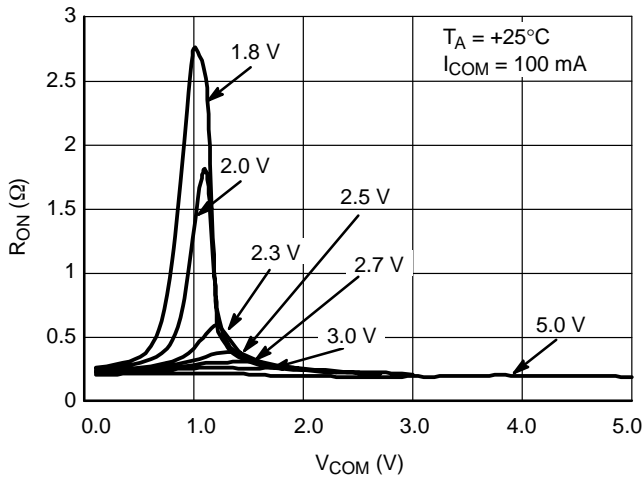


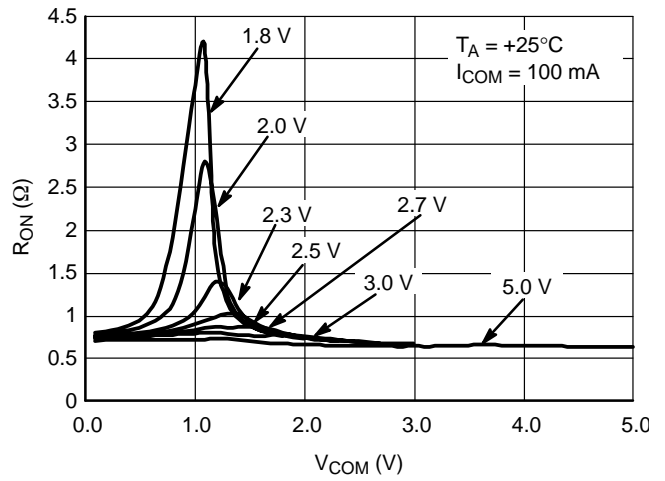
Figure 14.  $I_{CC}$  Current Leakage versus Temperature  $V_{CC} = 5.5 V$



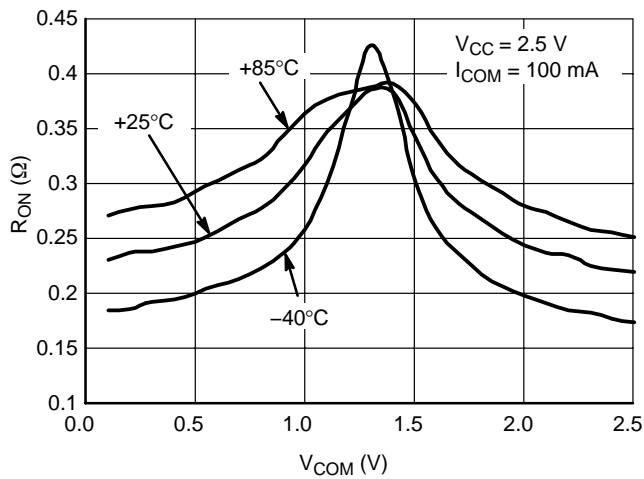
# NLAS4684



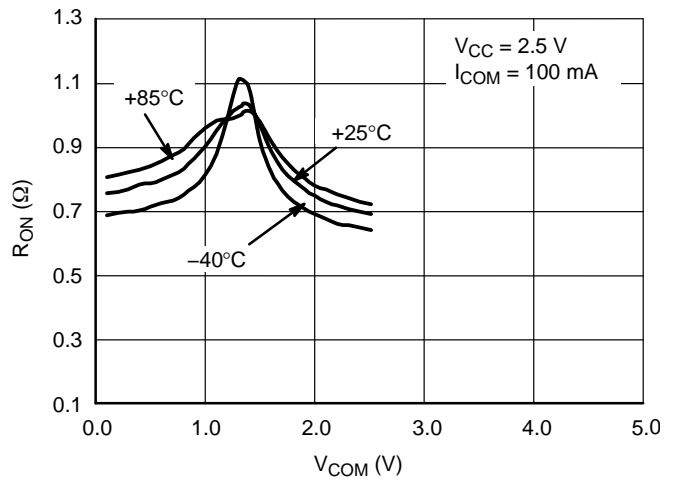
**Figure 15. NC On-Resistance versus COM Voltage**



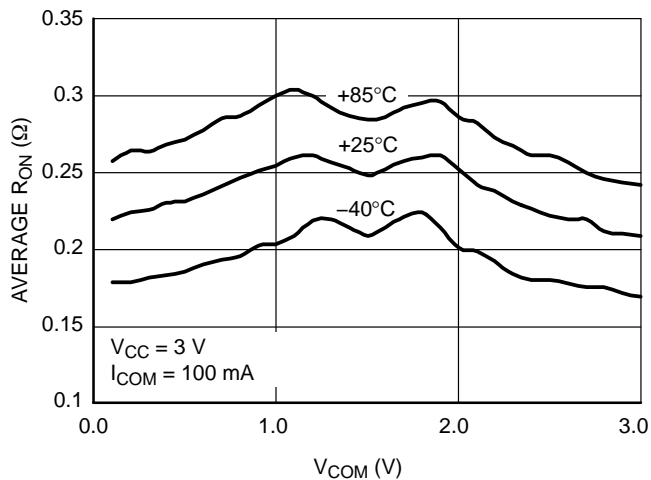
**Figure 16. NO On-Resistance versus COM Voltage**



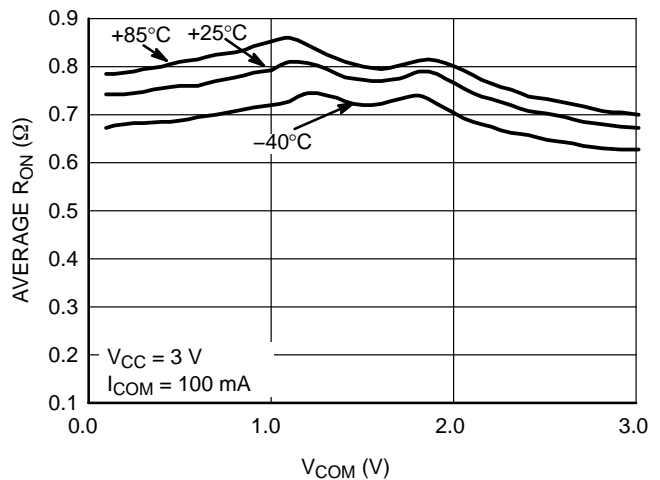
**Figure 17. NC On-Resistance versus COM Voltage**



**Figure 18. NO On-Resistance versus COM Voltage**

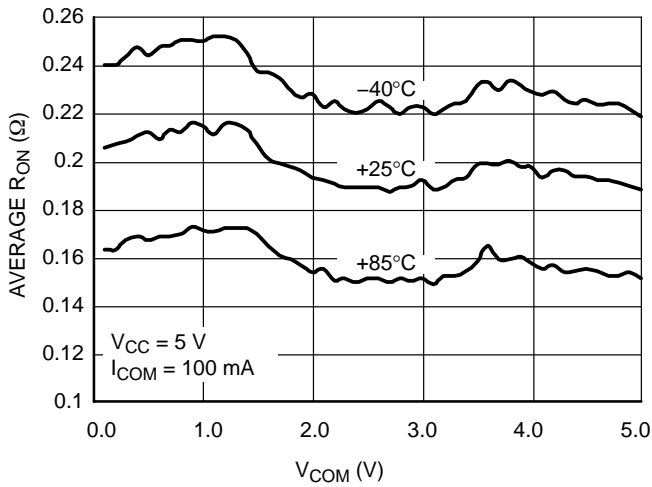


**Figure 19. NC On-Resistance versus COM Voltage**

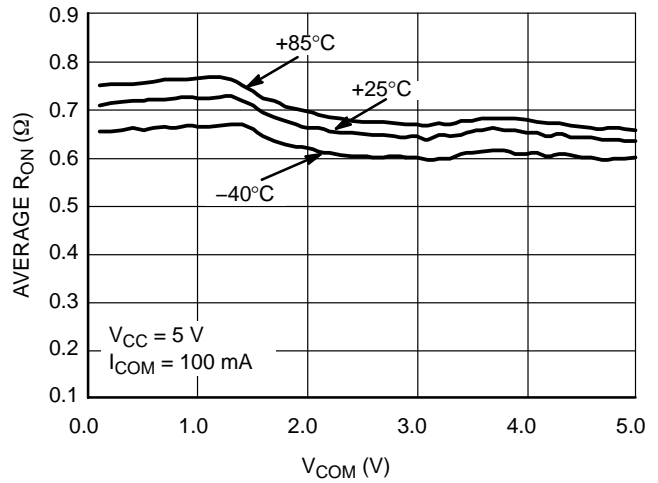


**Figure 20. NC On-Resistance versus COM Voltage**

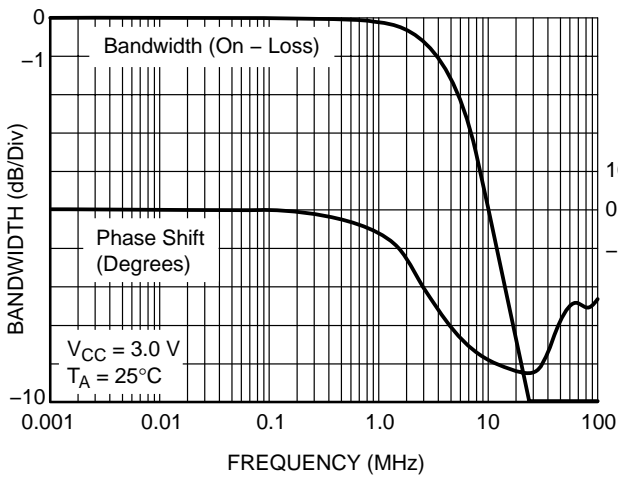
# NLAS4684



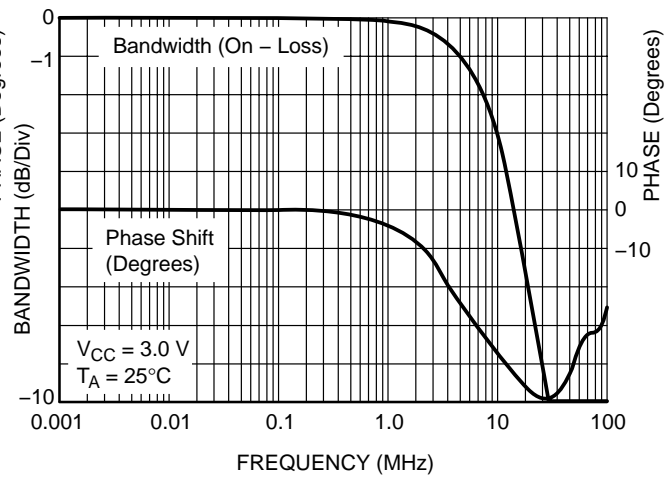
**Figure 21. NC On-Resistance versus COM Voltage**



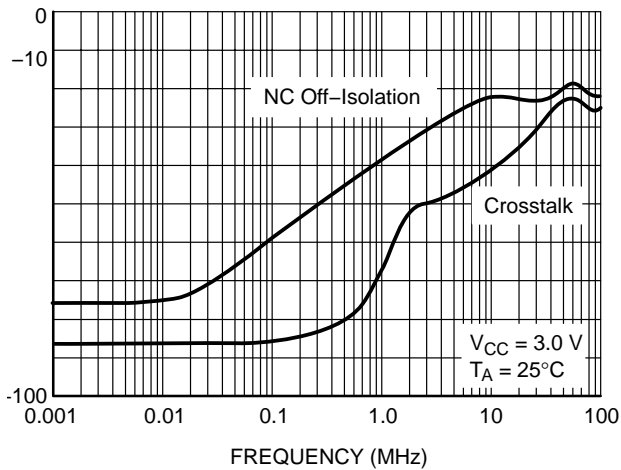
**Figure 22. NO On-Resistance versus COM Voltage**



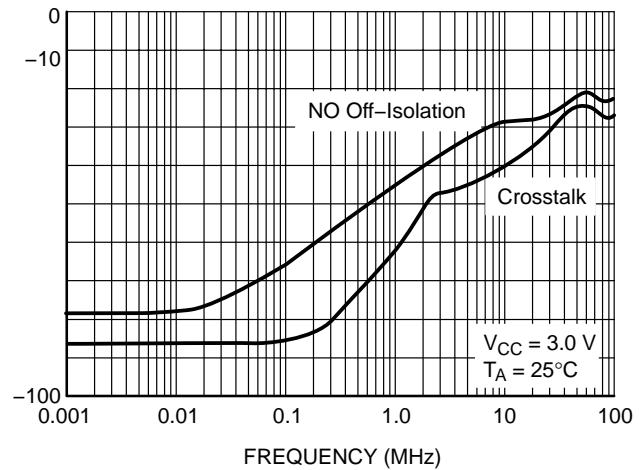
**Figure 23. NC Bandwidth and Phase Shift versus Frequency**



**Figure 24. NO Bandwidth and Phase Shift versus Frequency**



**Figure 25. NC Off Isolation and Crosstalk**



**Figure 26. NO Off Isolation and Crosstalk**

## NLAS4684

### ORDERING INFORMATION

Device	Package	Shipping†
NLAS4684FCT1	Microbump-10	3000 / Tape & Reel
NLAS4684FCT1G	Microbump-10 (Pb-Free)	3000 / Tape & Reel
NLAS4684MNR2	QFN-10	2500 / Tape & Reel
NLAS4684MNR2G	QFN-10 (Pb-Free)	2500 / Tape & Reel
NLAS4684MR2	Micro10	4000 / Tape & Reel
NLAS4684MR2G	Micro10 (Pb-Free)	4000 / Tape & Reel

†For information on tape and reel specifications, including part orientation and tape sizes, please refer to our Tape and Reel Packaging Specifications Brochure, BRD8011/D.

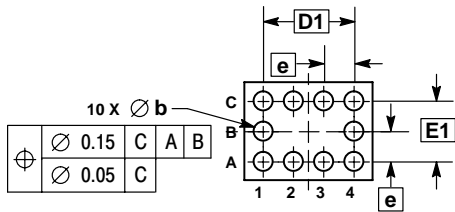
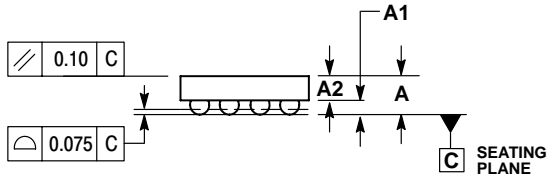
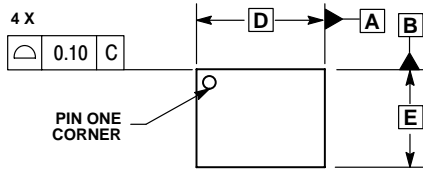
# NLAS4684

## PACKAGE DIMENSIONS

Microbump-10  
CASE 489AA-01  
ISSUE A

NOTES:

1. DIMENSIONING AND TOLERANCING PER ASME Y14.5M, 1994.
2. CONTROLLING DIMENSION: MILLIMETERS.
3. COPLANARITY APPLIES TO SPHERICAL CROWNS OF SOLDER BALLS.



DIM	MILLIMETERS	
	MIN	MAX
A	---	0.650
A1	0.210	0.270
A2	0.280	0.380
D	1.965 BSC	
E	1.465 BSC	
b	0.250	0.350
e	0.500 BSC	
D1	1.500 BSC	
E1	1.000 BSC	

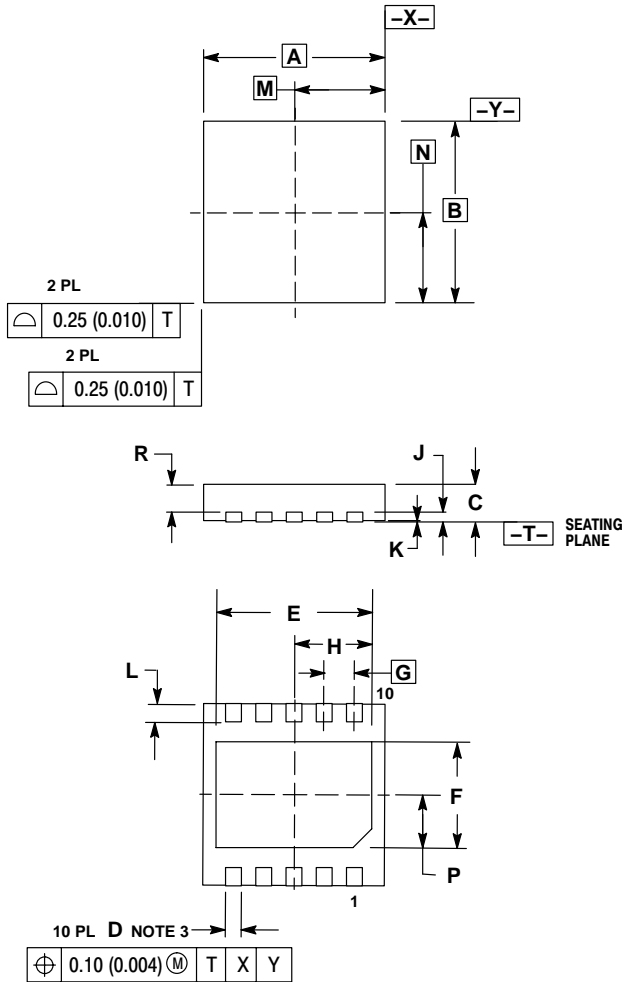
# NLAS4684

## PACKAGE DIMENSIONS

### QFN-10 (DUAL SIDED)

CASE 485C-01

ISSUE O



#### NOTES:

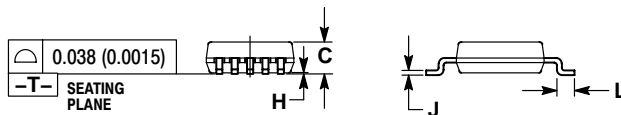
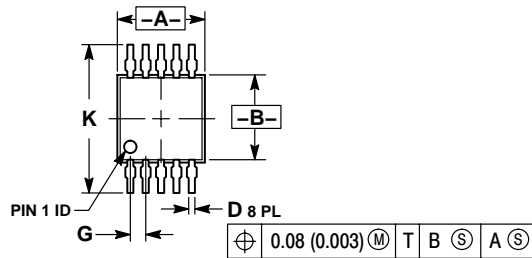
1. DIMENSIONING AND TOLERANCING PER ANSI Y14.5M, 1982.
2. CONTROLLING DIMENSION: MILLIMETERS.
3. DIMENSION D APPLIES TO PLATED TERMINAL AND IS MEASURED BETWEEN 0.25 AND 0.30 MM FROM TERMINAL.
4. COPLANARITY APPLIES TO THE EXPOSED PAD AS WELL AS THE TERMINALS.

DIM	MILLIMETERS		INCHES	
	MIN	MAX	MIN	MAX
A	3.00 BSC		0.118 BSC	
B	3.00 BSC		0.118 BSC	
C	0.80	1.00	0.031	0.039
D	0.20	0.30	0.008	0.012
E	2.45	2.55	0.096	0.100
F	1.75	1.85	0.069	0.073
G	0.50 BSC		0.020 BSC	
H	1.23	1.28	0.048	0.050
J	0.20 REF		0.008 REF	
K	0.00	0.05	0.000	0.002
L	0.35	0.45	0.014	0.018
M	1.50 BSC		0.059 BSC	
N	1.50 BSC		0.059 BSC	
P	0.88	0.93	0.035	0.037
R	0.60	0.80	0.024	0.031

# NLAS4684

## PACKAGE DIMENSIONS


**Micro10**  
CASE 846B-03  
ISSUE C



### NOTES:

1. DIMENSIONING AND TOLERANCING PER ANSI Y14.5M, 1982.
2. CONTROLLING DIMENSION: MILLIMETER.
3. DIMENSION "A" DOES NOT INCLUDE MOLD FLASH, PROTRUSIONS OR GATE BURRS. MOLD FLASH, PROTRUSIONS OR GATE BURRS SHALL NOT EXCEED 0.15 (0.006) PER SIDE.
4. DIMENSION "B" DOES NOT INCLUDE INTERLEAD FLASH OR PROTRUSION. INTERLEAD FLASH OR PROTRUSION SHALL NOT EXCEED 0.25 (0.010) PER SIDE.
5. 846B-01 OBSOLETE. NEW STANDARD 846B-02

DIM	MILLIMETERS		INCHES	
	MIN	MAX	MIN	MAX
A	2.90	3.10	0.114	0.122
B	2.90	3.10	0.114	0.122
C	0.95	1.10	0.037	0.043
D	0.20	0.30	0.008	0.012
G	0.50 BSC		0.020 BSC	
H	0.05	0.15	0.002	0.006
J	0.10	0.21	0.004	0.008
K	4.75	5.05	0.187	0.199
L	0.40	0.70	0.016	0.028

**ON Semiconductor** and  are registered trademarks of Semiconductor Components Industries, LLC (SCILLC). SCILLC reserves the right to make changes without further notice to any products herein. SCILLC makes no warranty, representation or guarantee regarding the suitability of its products for any particular purpose, nor does SCILLC assume any liability arising out of the application or use of any product or circuit, and specifically disclaims any and all liability, including without limitation special, consequential or incidental damages. "Typical" parameters which may be provided in SCILLC data sheets and/or specifications can and do vary in different applications and actual performance may vary over time. All operating parameters, including "Typicals" must be validated for each customer application by customer's technical experts. SCILLC does not convey any license under its patent rights nor the rights of others. SCILLC products are not designed, intended, or authorized for use as components in systems intended for surgical implant into the body, or other applications intended to support or sustain life, or for any other application in which the failure of the SCILLC product could create a situation where personal injury or death may occur. Should Buyer purchase or use SCILLC products for any such unintended or unauthorized application, Buyer shall indemnify and hold SCILLC and its officers, employees, subsidiaries, affiliates, and distributors harmless against all claims, costs, damages, and expenses, and reasonable attorney fees arising out of, directly or indirectly, any claim of personal injury or death associated with such unintended or unauthorized use, even if such claim alleges that SCILLC was negligent regarding the design or manufacture of the part. SCILLC is an Equal Opportunity/Affirmative Action Employer. This literature is subject to all applicable copyright laws and is not for resale in any manner.

### PUBLICATION ORDERING INFORMATION

#### LITERATURE FULFILLMENT:

Literature Distribution Center for ON Semiconductor  
P.O. Box 61312, Phoenix, Arizona 85082-1312 USA  
Phone: 480-829-7710 or 800-344-3860 Toll Free USA/Canada  
Fax: 480-829-7709 or 800-344-3867 Toll Free USA/Canada  
Email: orderlit@onsemi.com

**N. American Technical Support:** 800-282-9855 Toll Free  
USA/Canada

**Japan:** ON Semiconductor, Japan Customer Focus Center  
2-9-1 Kamimeguro, Meguro-ku, Tokyo, Japan 153-0051  
Phone: 81-3-5773-3850

**ON Semiconductor Website:** <http://onsemi.com>

**Order Literature:** <http://www.onsemi.com/litorder>

For additional information, please contact your local Sales Representative.