

SPECIFICATIONS FOR NICHIA UV LED

MODEL : **NSHU590A**

NICHIA CORPORATION

1.SPECIFICATIONS

(1) Absolute Maximum Ratings (Ta=25°C)

Item	Symbol	Absolute Maximum Rating	Unit
Forward Current	I _F	25	mA
Pulse Forward Current	I _{FP}	80	mA
Allowable Reverse Current	I _R	85	mA
Power Dissipation	P _D	100	mW
Operating Temperature	T _{opr}	-30 ~ + 85	°C
Storage Temperature	T _{stg}	-40 ~ +100	°C
Soldering Temperature	T _{sld}	265°C for 10sec.	

I_{FP} Conditions : Pulse Width \leq 10msec. and Duty \leq 1/10

(2) Initial Electrical/Optical Characteristics (Ta=25°C)

Item	Symbol	Condition	Min.	Typ.	Max.	Unit	
Forward Voltage	V _F	I _F =20[mA]	-	3.5	4.0	V	
Peak Wavelength	λ_P	I _F =20[mA]	370	375	380	nm	
Spectrum Half Width	$\Delta\lambda$	I _F =20[mA]	-	10	-	nm	
Optical Power Output	Rank 2	P _o	I _F =20[mA]	850	1000	1200	μ W
	Rank 3	P _o	I _F =20[mA]	1200	1400	1700	μ W
	Rank 4	P _o	I _F =20[mA]	1700	2000	2400	μ W

* Optical Power Output Measurement allowance is \pm 10%.

** Peak Wavelength Measurement allowance is \pm 3nm.

*** One delivery will include up to three different ranks of the products.

The quantity-ratio of the three ranks is decided by Nichia.

2.TYPICAL INITIAL OPTICAL/ELECTRICAL CHARACTERISTICS

Please refer to figure's page.

3.OUTLINE DIMENSIONS AND MATERIALS

Please refer to figure's page.

Material as follows ;

Glass	:	Hard Glass
Cap	:	Ni Plating Iron Alloy
Lead	:	Au Plating Iron Alloy

4.PACKAGING

- The LEDs are packed in cardboard boxes after packaging in anti-electrostatic bags.

Please refer to figure's page.

The label on the minimum packing unit shows ; Part Number, Lot Number, Ranking, Quantity

- In order to protect the LEDs from mechanical shock, we pack them in cardboard boxes for transportation.
- The LEDs may be damaged if the boxes are dropped or receive a strong impact against them, so precautions must be taken to prevent any damage.
- The boxes are not water resistant and therefore must be kept away from water and moisture.
- When the LEDs are transported, we recommend that you use the same packing method as Nichia.

5.LOT NUMBER

The first six digits number shows **lot number**.

The lot number is composed of the following characters;

○□×××× - △■

- - Year (3 for 2003, 4 for 2004)
- - Month (1 for Jan., 9 for Sep., A for Oct., B for Nov.)
- ×××× - Nichia's Product Number
- △ - Ranking by Wavelength
- - Ranking by Optical Power Output

6.RELIABILITY

(1) TEST ITEMS AND RESULTS

Test Item	Standard Test Method	Test Conditions	Note	Number of Damaged
Resistance to Soldering Heat	JEITA ED-4701 300 302	Tsld=260 ± 5°C, 10sec. 3mm from the base of the epoxy bulb	1 time	0/100
Solderability	JEITA ED-4701 300 303	Tsld=235 ± 5°C, 5sec. (using flux)	1 time over 95%	0/100
Thermal Shock	JEITA ED-4701 300 307	0°C ~ 100°C 15sec. 15sec.	100 cycles	0/100
Temperature Cycle	JEITA ED-4701 100 105	-40°C ~ 25°C ~ 100°C ~ 25°C 30min. 5min. 30min. 5min.	100 cycles	0/100
Moisture Resistance Cyclic	JEITA ED-4701 200 203	25°C ~ 65°C ~ -10°C 90%RH 24hrs./1cycle	10 cycles	0/100
Terminal Strength (bending test)	JEITA ED-4701 400 401	Load 5N (0.5kgf) 0° ~ 90° ~ 0° bend 2 times	Nonnoticeable damage	0/100
Terminal Strength (pull test)	JEITA ED-4701 400 401	Load 10N (1kgf) 10 ± 1 sec.	Nonnoticeable damage	0/100
High Temperature Storage	JEITA ED-4701 200 201	Ta=100°C	1000hrs.	0/100
Temperature Humidity Storage	JEITA ED-4701 100 103	Ta=60°C, RH=90%	1000hrs.	0/100
Low Temperature Storage	JEITA ED-4701 200 202	Ta=-40°C	1000hrs.	0/100
Steady State Operating Life		Ta=25°C, IF=25mA	500hrs.	0/100
Steady State Operating Life of High Humidity Heat		60°C, RH=90%, IF=15mA	500hrs.	0/100
Steady State Operating Life of Low Temperature		Ta=-30°C, IF=20mA	1000hrs.	0/100

(2) CRITERIA FOR JUDGING THE DAMAGE

Item	Symbol	Test Conditions	Criteria for Judgement	
			Min.	Max.
Forward Voltage	V _F	I _F =20mA	-	U.S.L.*) × 1.1
Optical Power Output	P _o	I _F =20mA	L.S.L.***) × 0.7	-

*) U.S.L. : Upper Standard Level

**) L.S.L. : Lower Standard Level

7. CAUTIONS

(1) Cautions

- The devices are UV light LEDs. The LED during operation radiates intense UV light, which precautions must be taken to prevent looking directly at the UV light with unaided eyes. Do not look directly into the UV light or look through the optical system. When there is a possibility to receive the reflection of light, protect by using the UV light protective glasses so that light should not catch one's eye directly.
- Put the caution label on the cardboard box.



(2) Lead Forming

- When forming leads, the leads should be bent at a point at least 3mm from the base of the lead. Do not use the base of the leadframe as a fulcrum during lead forming.
- Lead forming should be done before soldering.
- Do not apply any bending stress to the base of the lead. The stress to the base may damage the LED's characteristics or it may break the LEDs.
- When mounting the LEDs onto a printed circuit board, the holes on the circuit board should be exactly aligned with the leads of the LEDs. If the LEDs are mounted with stress at the leads, it causes deterioration of the lead and this will degrade the LEDs.

(3) Storage

- The LEDs should be stored at 30°C or less and 70%RH or less after being shipped from Nichia and the storage life limits are 3 months. If the LEDs are stored for 3 months or more, they can be stored for a year in a sealed container with a nitrogen atmosphere and moisture absorbent material.
- Nichia LED leads are comprised of a gold plated Iron alloy. The gold surface may be affected by environments which contain corrosive gases and so on. Please avoid conditions which may cause the LED to corrode, tarnish or discolor. This corrosion or discoloration may cause difficulty during soldering operations. It is recommended that the LEDs be used as soon as possible.
- Please avoid rapid transitions in ambient temperature, especially, in high humidity environments where condensation can occur.

(4) Static Electricity

- Static electricity or surge voltage damages the LEDs.
It is recommended that a wrist band or an anti-electrostatic glove be used when handling the LEDs.
- All devices, equipment and machinery must be properly grounded. It is recommended that measures be taken against surge voltage to the equipment that mounts LEDs.
- When inspecting the final products in which LEDs were assembled, it is recommended to check whether the assembled LEDs are damaged by static electricity or not. It is easy to find static-damaged LEDs by a light-on test or a VF test at a lower current (below 1mA is recommended). The LEDs should be used the light detector etc. when testing the light-on. Do not stare into the LEDs when testing.
- Damaged LEDs will show some unusual characteristics such as the forward voltage becomes lower, or the LEDs do not light at the low current.

Criteria : (VF > 2.0V at IF=0.5mA)

(5) Soldering Conditions

- Solder the LED no closer than 3mm from the base of the lead.
- Recommended soldering conditions

Dip Soldering		Soldering	
Pre-Heat	120°C Max.	Temperature	350°C Max.
Pre-Heat Time	60 seconds Max.	Soldering Time	3 seconds Max.
Solder Bath Temperature	260°C Max.	Position	No closer than 3 mm from the base of the lead.
Dipping Time	10 seconds Max.		
Dipping Position	No lower than 3 mm from the base of the lead.		

- Do not apply any stress to the lead particularly when heated.
- The LEDs must not be repositioned after soldering.
- After soldering the LEDs, the lead should be protected from mechanical shock or vibration until the LEDs return to room temperature.
- Direct soldering onto a PC board should be avoided. Mechanical stress to the glass may be caused from warping of the PC board or from the clinching and cutting of the leads. When it is absolutely necessary, the LEDs may be mounted in this fashion but the User will assume responsibility for any problems. Direct soldering should only be done after testing has confirmed that no damage, such as wire bond failure or glass deterioration, will occur. Nichia's LEDs should not be soldered directly to double sided PC boards because the heat will deteriorate the glass.
- When it is necessary to clamp the LEDs to prevent soldering failure, it is important to minimize the mechanical stress on the LEDs.
- Cut the LED leads at room temperature. Cutting the leads at high temperatures may cause failure of the LEDs.

(6) Heat Generation

- Thermal design of the end product is of paramount importance. Please consider the heat generation of the LED when making the system design. The coefficient of temperature increase per input electric power is affected by the thermal resistance of the circuit board and density of LED placement on the board, as well as other components. It is necessary to avoid intense heat generation and operate within the maximum ratings given in this specification.
- The operating current should be decided after considering the ambient maximum temperature of LEDs.

(7) Cleaning

- It is recommended that isopropyl alcohol be used as a solvent for cleaning the LEDs. When using other solvents, it should be confirmed beforehand whether the solvents will dissolve the resin or not. Freon solvents should not be used to clean the LEDs because of worldwide regulations.
- Do not clean the LEDs by the ultrasonic. When it is absolutely necessary, the influence of ultrasonic cleaning on the LEDs depends on factors such as ultrasonic power and the assembled condition. Before cleaning, a pre-test should be done to confirm whether any damage to the LEDs will occur.

(8) Safety Guideline for Human Eyes

- In 1993, the International Electric Committee (IEC) issued a standard concerning laser product safety (IEC 825-1). Since then, this standard has been applied for diffused light sources (LEDs) as well as lasers. In 1998 IEC 60825-1 Edition 1.1 evaluated the magnitude of the light source. In 2001 IEC 60825-1 Amendment 2 converted the laser class into 7 classes for end products. Components are excluded from this system. Products which contain visible LEDs are now classified as class 1. Products containing UV LEDs are class 1M. Products containing LEDs can be classified as class 2 in cases where viewing angles are narrow, optical manipulation intensifies the light, and/or the energy emitted is high. For these systems it is recommended to avoid long term exposure. It is also recommended to follow the IEC regulations regarding safety and labeling of products.

(9) Others

- The LEDs described in this brochure are intended to be used for ordinary electronic equipment (such as office equipment, communications equipment, measurement instruments and household appliances). Consult Nichia's sales staff in advance for information on the applications in which exceptional quality and reliability are required, particularly when the failure or malfunction of the LEDs may directly jeopardize life or health (such as for airplanes, aerospace, submersible repeaters, nuclear reactor control systems, automobiles, traffic control equipment, life support systems and safety devices).
- User shall not reverse engineer by disassembling or analysis of the LEDs without having the prior written consent of Nichia. When defective LEDs are found, User shall inform to Nichia directly before disassembling or analysis.
- The formal specifications must be exchanged and signed by both parties before large volume purchase begins.
- The appearance and specifications of the product may be modified for improvement without notice.

■ Forward Voltage vs. Forward Current

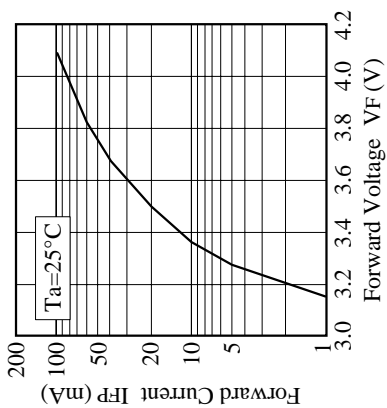

■ Forward Current vs. Relative Power Output

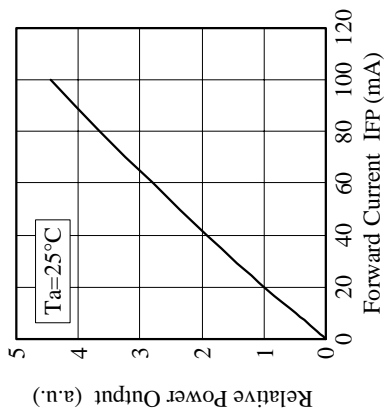

■ Duty Ratio vs. Allowable Forward Current

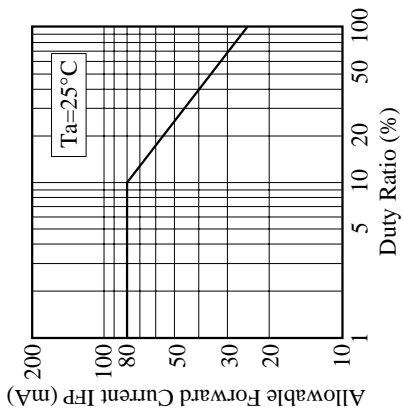

■ Ambient Temperature vs. Forward Voltage

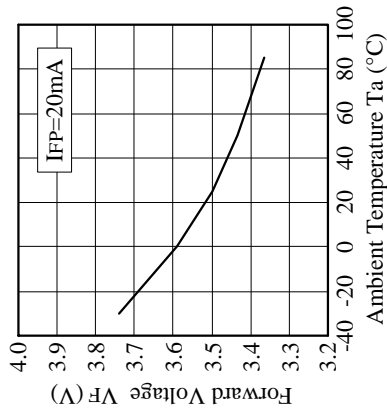

■ Ambient Temperature vs. Relative Power Output

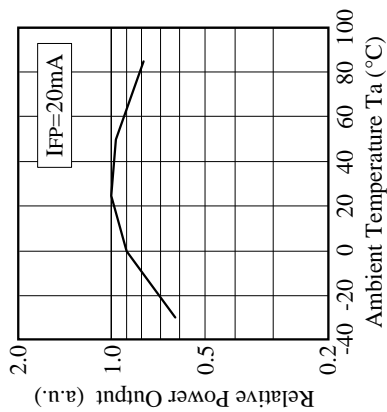

■ Ambient Temperature vs. Allowable Forward Current

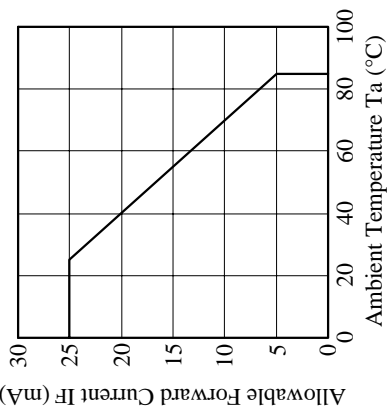

NICHIA CORPORATION	Model	NSHUxxxxA
	Title TYP.CHARACTERISTICS	
	No.	040121421401

■ Spectrum

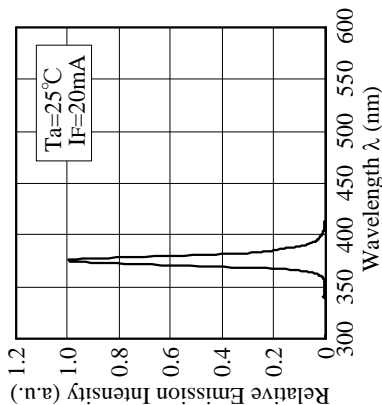

■ Directivity (NSHU590A)

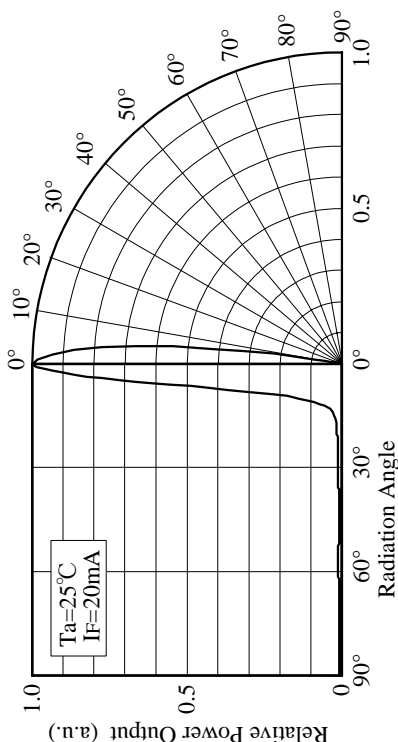

■ Forward Current vs. Peak Wavelength

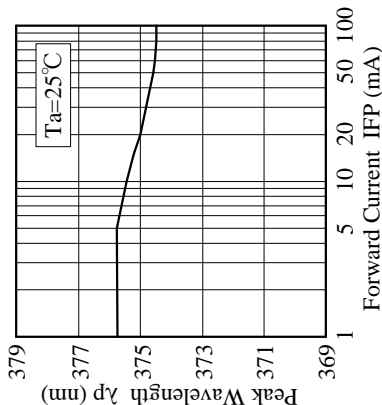

■ Ambient Temperature vs. Peak Wavelength

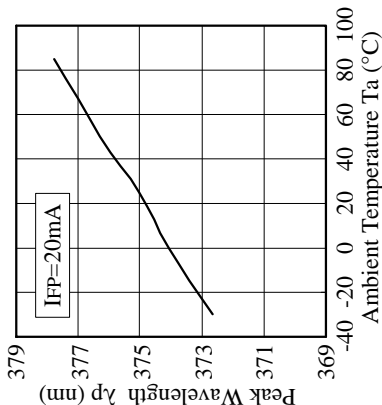

Model		NSHU590A
No.		031202200913

NICHIA CORPORATION

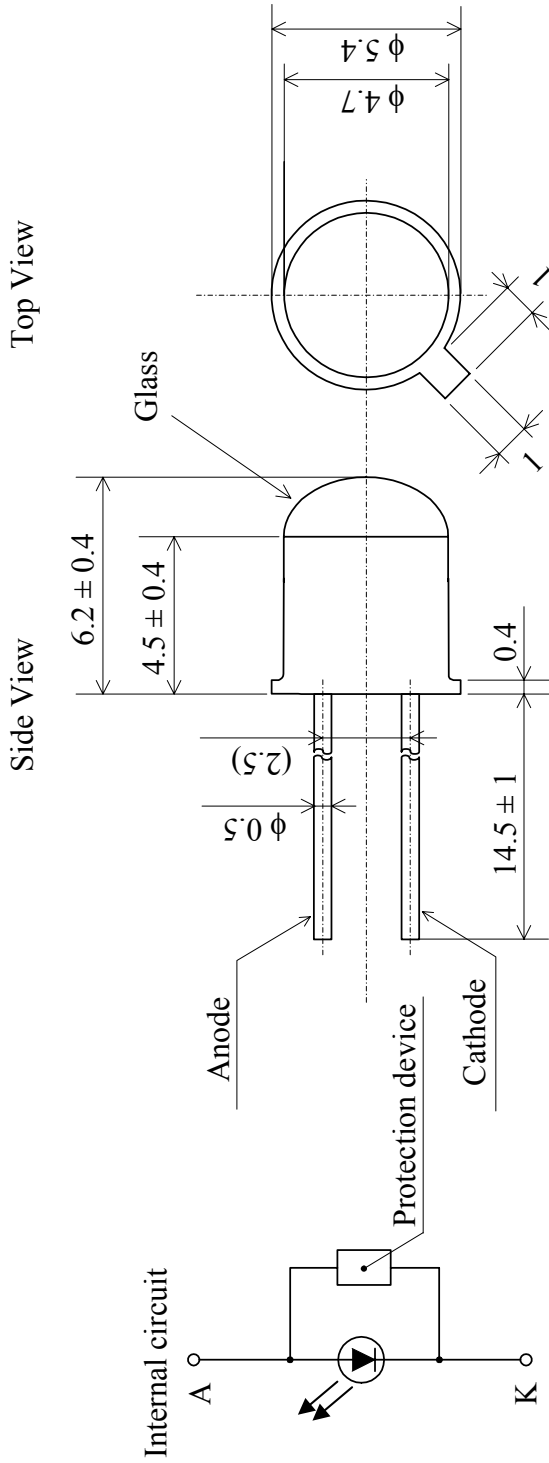

* NSHU590A has a protection device built in as a protection circuit against static electricity.

ITEM	MATERIALS
GLASS	Hard Glass
CAP	Ni Plating Iron Alloy
LEAD	Au Plating Iron Alloy

NICHIA CORPORATION	Model	NSHU590A	Unit	mm
	Title	OUTLINE DIMENSIONS	5/1	Scale
	No.	020705200151	Allow	± 0.2

Print

NICHIA
UV LED
TYPE NSHUxxx

LOT xxxxxx-△ ■ pcs
QTY
NICHIA CORPORATION
491 OKA, KAMINAKA, ANAN, TOKUSHIMA, JAPAN

UV LED

LED放射
光学測定装置で
直接観察してはならない
クラスII LED製品

LED RADIATION
DO NOT VIEW DIRECTLY WITH
OPTICAL INSTRUMENTS
CLASS II LED PRODUCT

CAUTION TO ELECTROSTATIC DAMAGE
静電気に注意

Cardboard

Anti electrostatic bag

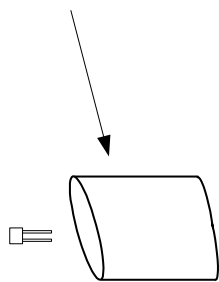

The quantity is printed on this bag.

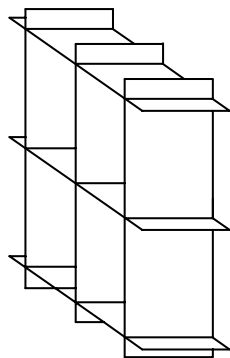

Cardboard

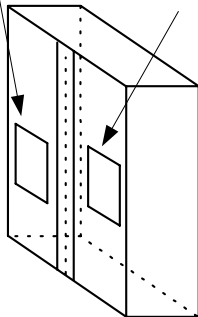

Caution Label

LED放射
光学測定装置で
直接観察してはならない
クラスII LED製品

LED RADIATION
DO NOT VIEW DIRECTLY WITH
OPTICAL INSTRUMENTS
CLASS II LED PRODUCT

UV LED

* Put the label and caution label on the cardboard box.

Label

NICHIA

UV LED
TYPE NSHUxxx
RANK △ ■ PCS
QTY

NICHIA CORPORATION
491 OKA, KAMINAKA, ANAN, TOKUSHIMA, JAPAN

Cardboard box
360×135×215×4t

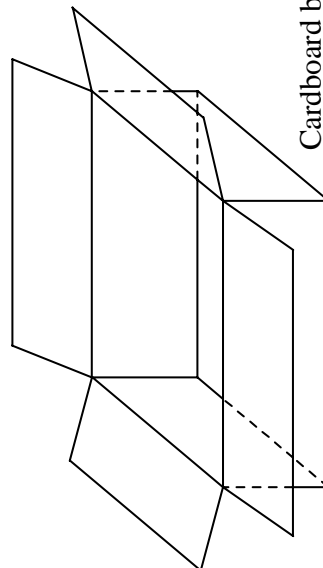

* One box contains 8 bags at maximum.

NICHIA CORPORATION	Model	NSHUxxx
	Title	PACKING
	No.	030826314421

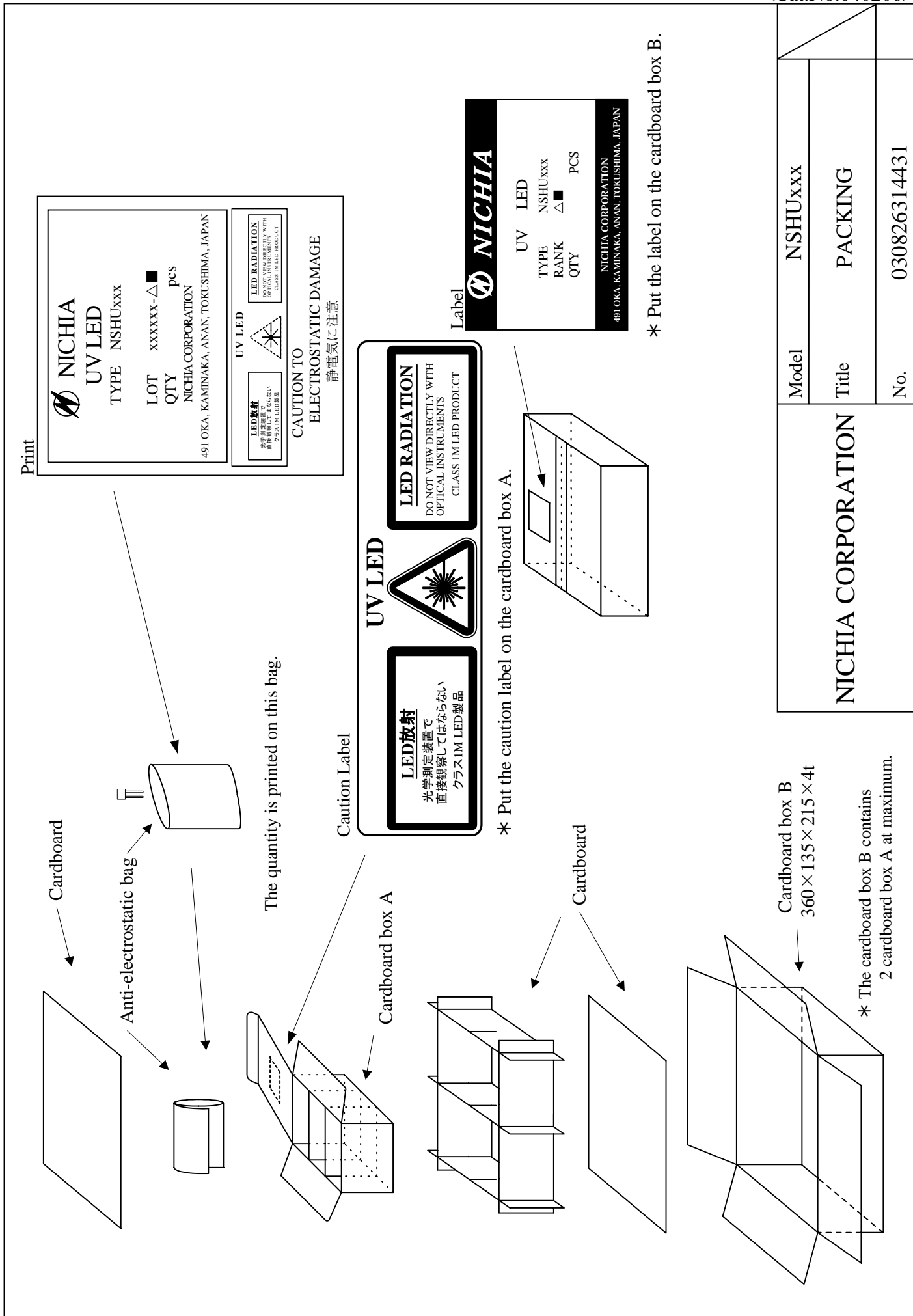

Print

NICHIA
UV LED
 TYPE NSHUxxx
 LOT xxxxxx-△■
 QTY pcs
 NICHIA CORPORATION
 491 OKA, KAMINAKA, ANAN, TOKUSHIMA, JAPAN

LED放射
 光学測定装置で
 直接観察してはならない
 クラスIM LED製品

LED RADIATION
 DO NOT VIEW DIRECTLY WITH
 OPTICAL INSTRUMENTS WITH
 CLASS IM LED PRODUCT

UV LED

CAUTION TO ELECTROSTATIC DAMAGE
 静電気に注意

The quantity is printed on this bag.

Caution Label

UV LED

LED放射
 光学測定装置で
 直接観察してはならない
 クラスIM LED製品

LED RADIATION
 DO NOT VIEW DIRECTLY WITH
 OPTICAL INSTRUMENTS
 CLASS IM LED PRODUCT

NICHIA

UV LED
 TYPE NSHUxxx
 RANK △■
 QTY PCS

NICHIA CORPORATION
 491 OKA, KAMINAKA, ANAN, TOKUSHIMA, JAPAN

* Put the caution label on the cardboard box A.

* Put the label on the cardboard box B.

Cardboard box B
 360 × 135 × 215 × 4t

* The cardboard box B contains
 2 cardboard box A at maximum.

NICHIA CORPORATION	Model	NSHUxxx
	Title	PACKING
	No.	030826314431

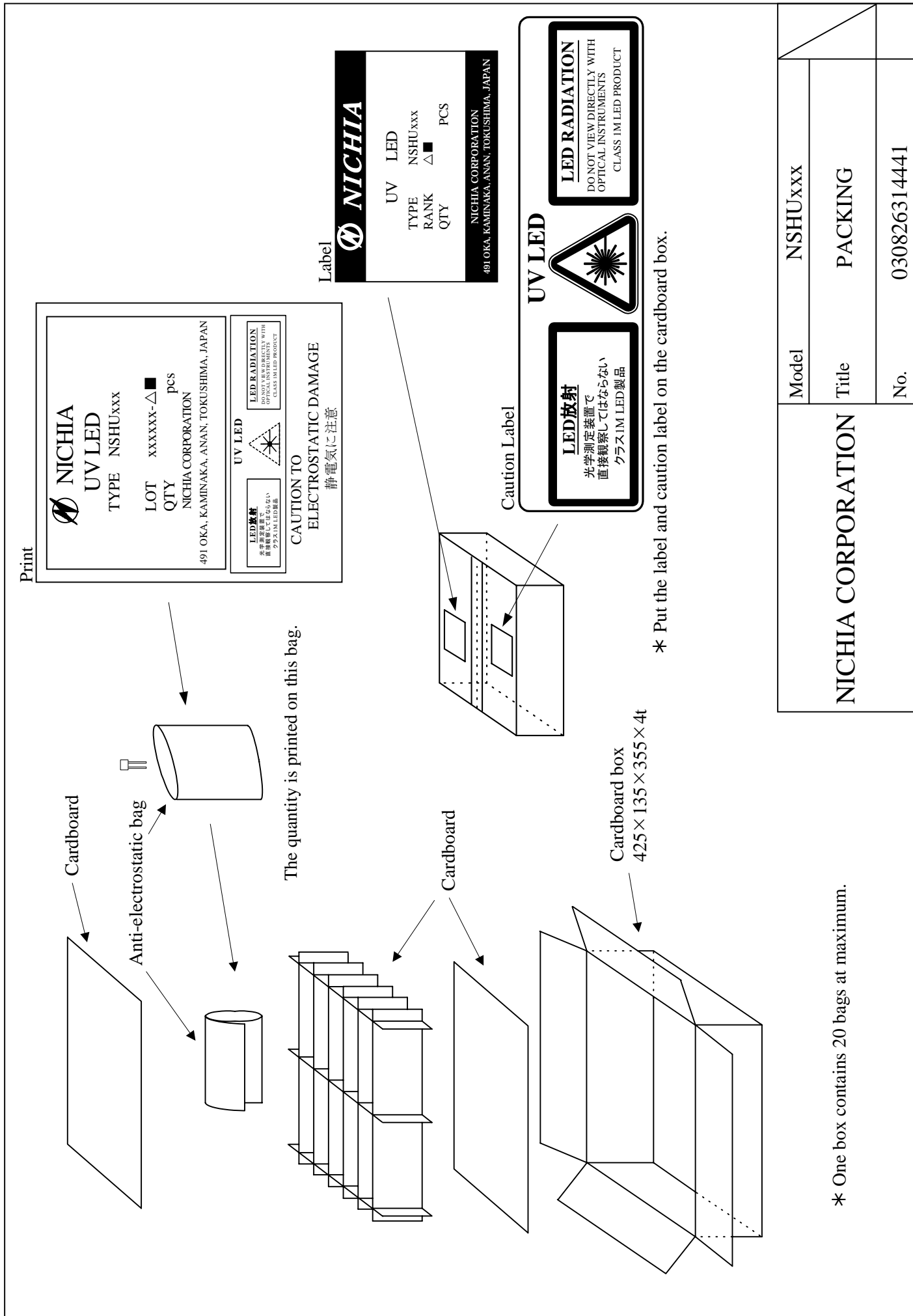

Print

NICHIA
UV LED
 TYPE NSHUxxx

LOT xxxxx-△■ pcs
 QTY
 NICHIA CORPORATION
 491 OKA, KAMINAKA, ANAN, TOKUSHIMA, JAPAN

LED放射
 光学測定装置で
 直接観察してはならない
 クラスIM LED製品

UV LED

LED RADIATION
 DO NOT VIEW DIRECTLY WITH
 OPTICAL INSTRUMENTS
 CLASS IM LED PRODUCT

CAUTION TO
ELECTROSTATIC DAMAGE
 静電気に注意

NICHIA

UV LED
 TYPE NSHUxxx
 RANK △■ PCS
 QTY

NICHIA CORPORATION
 491 OKA, KAMINAKA, ANAN, TOKUSHIMA, JAPAN

Caution Label

LED放射
 光学測定装置で
 直接観察してはならない
 クラスIM LED製品

UV LED

LED RADIATION
 DO NOT VIEW DIRECTLY WITH
 OPTICAL INSTRUMENTS
 CLASS IM LED PRODUCT

* Put the label and caution label on the cardboard box.

NICHIA CORPORATION	Model	NSHUxxx
	Title	PACKING
	No.	030826314441

* One box contains 20 bags at maximum.

Cardboard box
 425×135×355×4t

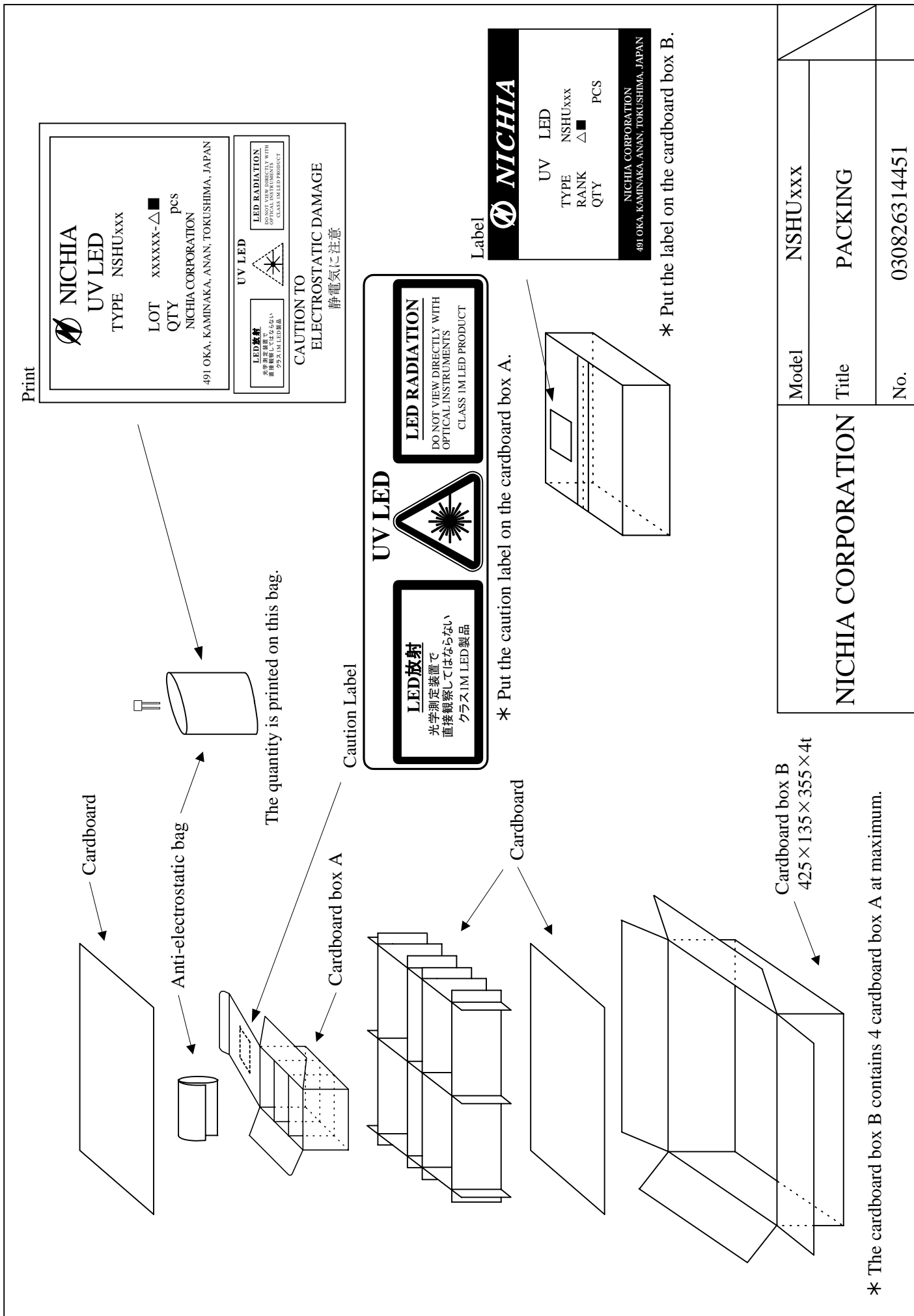

Print

NICHIA
UV LED
 TYPE NSHUxxx
 LOT xxxxxx-△■
 QTY pcs
 NICHIA CORPORATION
 491 OKA, KAMINAKA, ANAN, TOKUSHIMA, JAPAN

UV LED
 LED RADIATION DO NOT VIEW DIRECTLY WITH OPTICAL INSTRUMENTS CLASS II LED PRODUCT

LED放射
 光学測定装置で直接観察してはならない
 クラスII LED製品

CAUTION TO ELECTROSTATIC DAMAGE
 静電気に注意

The quantity is printed on this bag.

Caution Label

Label

NICHIA

UV LED
 TYPE NSHUxxx
 RANK Δ
 QTY PCS

NICHIA CORPORATION
 491 OKA, KAMINAKA, ANAN, TOKUSHIMA, JAPAN

* Put the caution label on the cardboard box A.

* Put the label on the cardboard box B.

Cardboard box B
 425 × 135 × 355 × 4t

* The cardboard box B contains 4 cardboard box A at maximum.

Model	NSHUxxx
Title	PACKING
No.	030826314451

NICHIA CORPORATION