

# NSS30101LT1G

## 30 V, 2 A, Low $V_{CE(sat)}$ NPN Transistor

ON Semiconductor's e<sup>2</sup>PowerEdge family of low  $V_{CE(sat)}$  transistors are miniature surface mount devices featuring ultra low saturation voltage ( $V_{CE(sat)}$ ) and high current gain capability. These are designed for use in low voltage, high speed switching applications where affordable efficient energy control is important.

Typical application are DC-DC converters and power management in portable and battery powered products such as cellular and cordless phones, PDAs, computers, printers, digital cameras and MP3 players. Other applications are low voltage motor controls in mass storage products such as disc drives and tape drives. In the automotive industry they can be used in air bag deployment and in the instrument cluster. The high current gain allows e<sup>2</sup>PowerEdge devices to be driven directly from PMU's control outputs, and the Linear Gain (Beta) makes them ideal components in analog amplifiers.

- This is a Pb-Free Device

### MAXIMUM RATINGS ( $T_A = 25^\circ\text{C}$ )

Rating	Symbol	Max	Unit
Collector-Emitter Voltage	$V_{CEO}$	30	Vdc
Collector-Base Voltage	$V_{CBO}$	50	Vdc
Emitter-Base Voltage	$V_{EBO}$	5.0	Vdc
Collector Current – Continuous	$I_C$	1.0	A
Collector Current – Peak	$I_{CM}$	2.0	A

### THERMAL CHARACTERISTICS

Characteristic	Symbol	Max	Unit
Total Device Dissipation $T_A = 25^\circ\text{C}$ Derate above $25^\circ\text{C}$	$P_D$ (Note 1)	310	mW
		2.5	mW/ $^\circ\text{C}$
Thermal Resistance, Junction to Ambient	$R_{\theta JA}$ (Note 1)	403	$^\circ\text{C}/\text{W}$
Total Device Dissipation $T_A = 25^\circ\text{C}$ Derate above $25^\circ\text{C}$	$P_D$ (Note 2)	710	mW
		5.7	mW/ $^\circ\text{C}$
Thermal Resistance, Junction to Ambient	$R_{\theta JA}$ (Note 2)	176	$^\circ\text{C}/\text{W}$
Total Device Dissipation (Single Pulse < 10 sec.)	$P_{Dsingle}$	575	mW
Junction and Storage Temperature Range	$T_J, T_{stg}$	-55 to +150	$^\circ\text{C}$

Maximum ratings are those values beyond which device damage can occur. Maximum ratings applied to the device are individual stress limit values (not normal operating conditions) and are not valid simultaneously. If these limits are exceeded, device functional operation is not implied, damage may occur and reliability may be affected.

1. FR-4 @ Minimum Pad.
2. FR-4 @ 1.0 X 1.0 inch Pad.



**ON Semiconductor®**

<http://onsemi.com>

**30 VOLTS  
2.0 AMPS  
NPN LOW  $V_{CE(sat)}$  TRANSISTOR  
EQUIVALENT  $R_{DS(on)} 100\text{ m}\Omega$**

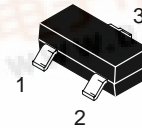
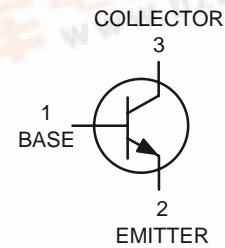

**SOT-23 (TO-236)  
CASE 318  
STYLE 6**

### DEVICE MARKING



VS6 = Specific Device Code

### ORDERING INFORMATION

Device	Package	Shipping†
NSS30101LT1G	SOT-23 (Pb-Free)	3000/Tape & Reel

†For information on tape and reel specifications, including part orientation and tape sizes, please refer to our Tape and Reel Packaging Specification Brochure, BRD8011/D.



# NSS30101LT1G

## ELECTRICAL CHARACTERISTICS (T<sub>A</sub> = 25°C unless otherwise noted)

Characteristic	Symbol	Min	Max	Unit
<b>OFF CHARACTERISTICS</b>				
Collector–Emitter Breakdown Voltage (I <sub>C</sub> = 10 mA, I <sub>B</sub> = 0)	V <sub>(BR)CEO</sub>	30	–	Vdc
Collector–Base Breakdown Voltage (I <sub>C</sub> = 0.1 mA, I <sub>E</sub> = 0)	V <sub>(BR)CBO</sub>	50	–	Vdc
Emitter–Base Breakdown Voltage (I <sub>E</sub> = 0.1 mA, I <sub>C</sub> = 0)	V <sub>(BR)EBO</sub>	5.0	–	Vdc
Collector Cutoff Current (V <sub>CB</sub> = 30 Vdc, I <sub>E</sub> = 0)	I <sub>CBO</sub>	–	0.1	μA <sub>dc</sub>
Collector–Emitter Cutoff Current (V <sub>CE</sub> = 30 Vdc)	I <sub>CES</sub>	–	0.1	μA <sub>dc</sub>
Emitter Cutoff Current (V <sub>EB</sub> = 4.0 Vdc)	I <sub>EBO</sub>	–	0.1	μA <sub>dc</sub>

## ON CHARACTERISTICS

DC Current Gain (Note 3) (I <sub>C</sub> = 50 mA, V <sub>CE</sub> = 5.0 V) (I <sub>C</sub> = 0.5 A, V <sub>CE</sub> = 5.0 V) (I <sub>C</sub> = 1.0 A, V <sub>CE</sub> = 5.0 V)	h <sub>FE</sub>	300 300 200	– 900 –	
Collector–Emitter Saturation Voltage (Note 3) (I <sub>C</sub> = 1.0 A, I <sub>B</sub> = 100 mA) (I <sub>C</sub> = 0.5 A, I <sub>B</sub> = 50 mA) (I <sub>C</sub> = 0.1 A, I <sub>B</sub> = 1.0 mA)	V <sub>CE(sat)</sub>	– – –	0.200 0.125 0.075	V
Base–Emitter Saturation Voltage (Note 3) (I <sub>C</sub> = 1.0 A, I <sub>B</sub> = 0.1 A)	V <sub>BE(sat)</sub>	–	1.1	V
Base–Emitter Turn–on Voltage (Note 3) (I <sub>C</sub> = 1.0 mA, V <sub>CE</sub> = 2.0 V)	V <sub>BE(on)</sub>	–	1.1	V
Cutoff Frequency (I <sub>C</sub> = 100 mA, V <sub>CE</sub> = 5.0 V, f = 100 MHz)	f <sub>T</sub>	100	–	MHz
Output Capacitance (f = 1.0 MHz)	C <sub>obo</sub>	–	15	pF

3. Pulsed Condition: Pulse Width = 300 μsec, Duty Cycle ≤ 2%

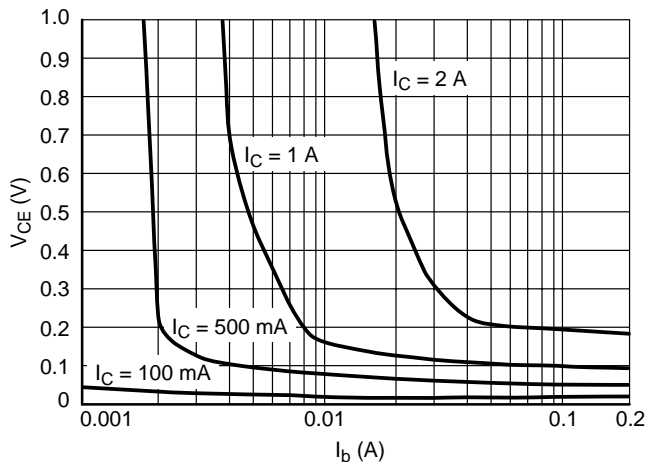

Figure 1. V<sub>CE</sub> versus I<sub>b</sub>

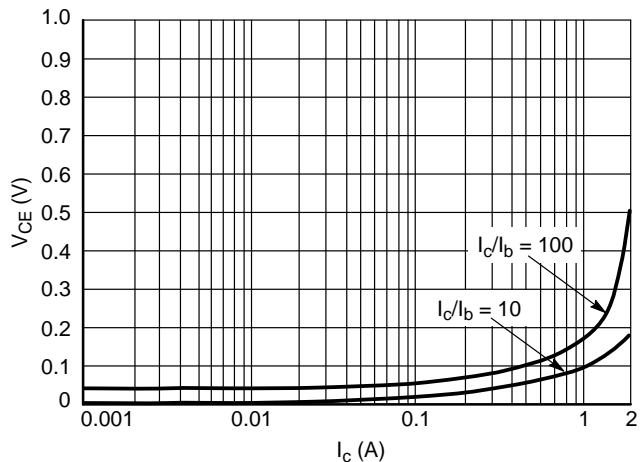

Figure 2. V<sub>CE</sub> versus I<sub>c</sub>

# NSS30101LT1G

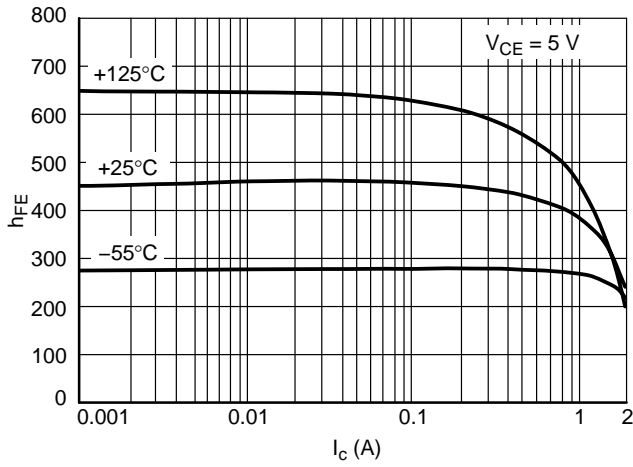

Figure 3.  $h_{FE}$  versus  $I_C$

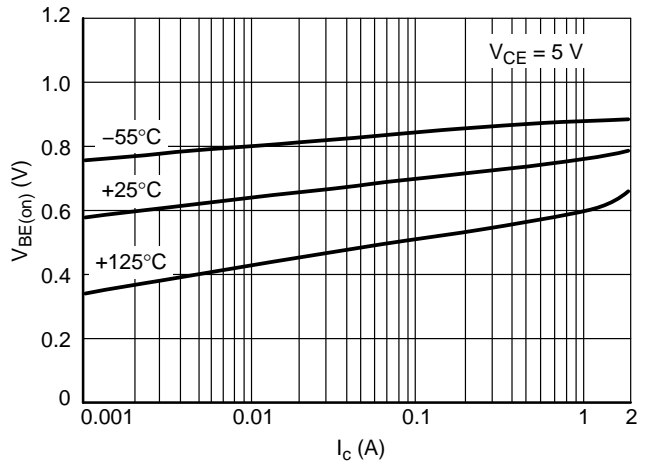

Figure 4.  $V_{BE(on)}$  versus  $I_C$

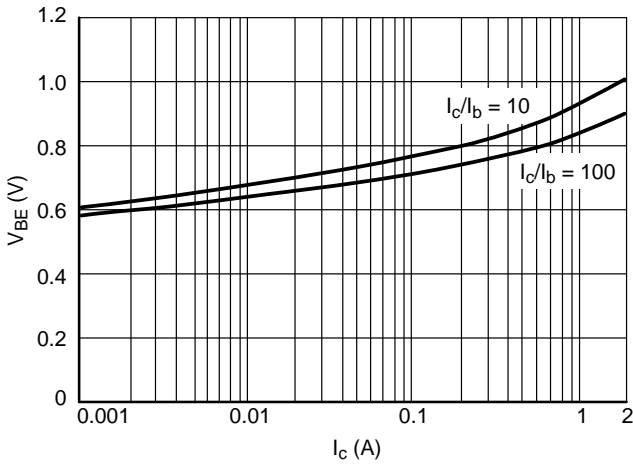

Figure 5.  $V_{BE(sat)}$  versus  $I_C$

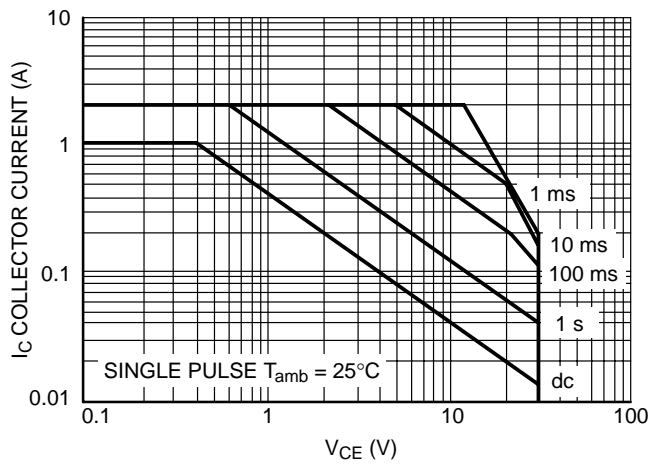

Figure 6. Safe Operating Area

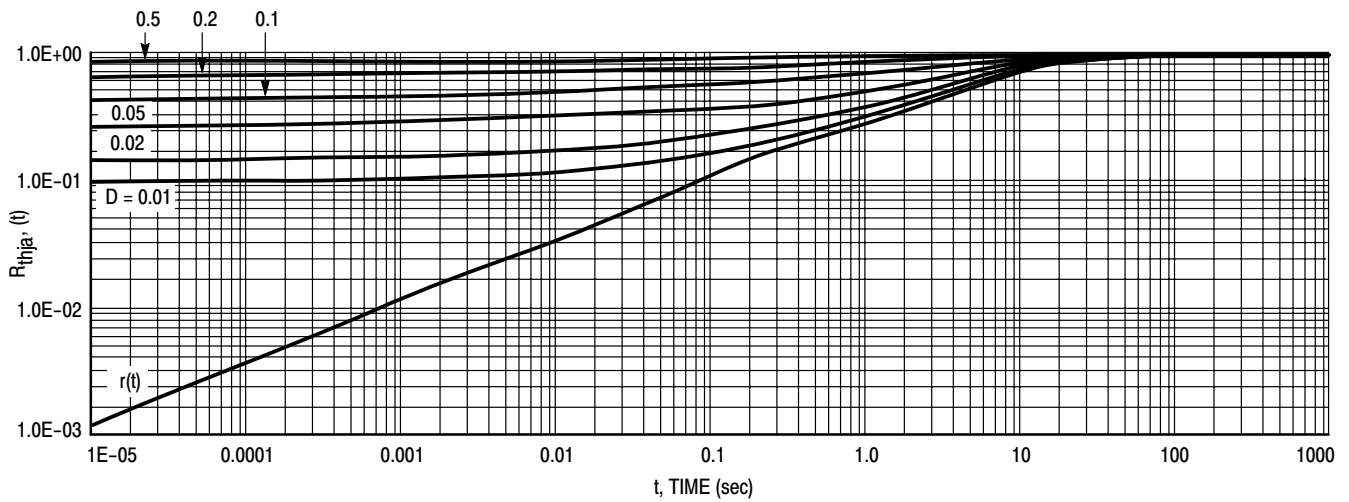
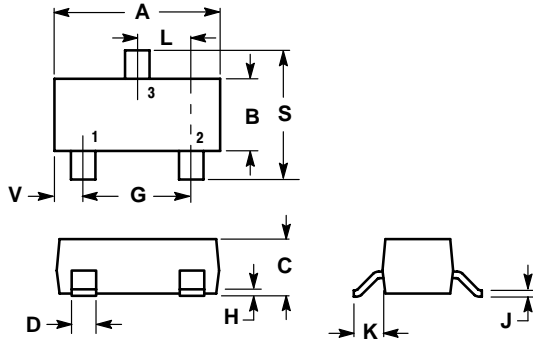

Figure 7. Normalized Thermal Response

# NSS30101LT1G

## PACKAGE DIMENSIONS

SOT-23 (TO-236)  
CASE 318-08  
ISSUE AH



NOTES:

1. DIMENSIONING AND TOLERANCING PER ANSI Y14.5M, 1982.
2. CONTROLLING DIMENSION: INCH.
3. MAXIMUM LEAD THICKNESS INCLUDES LEAD FINISH THICKNESS. MINIMUM LEAD THICKNESS IS THE MINIMUM THICKNESS OF BASE MATERIAL.
4. 318-03 AND -07 OBSOLETE, NEW STANDARD 318-08.

DIM	INCHES		MILLIMETERS	
	MIN	MAX	MIN	MAX
A	0.1102	0.1197	2.80	3.04
B	0.0472	0.0551	1.20	1.40
C	0.0350	0.0440	0.89	1.11
D	0.0150	0.0200	0.37	0.50
G	0.0701	0.0807	1.78	2.04
H	0.0005	0.0040	0.013	0.100
J	0.0034	0.0070	0.085	0.177
K	0.0140	0.0285	0.35	0.69
L	0.0350	0.0401	0.89	1.02
S	0.0830	0.1039	2.10	2.64
V	0.0177	0.0236	0.45	0.60

STYLE 6:

- PIN 1. BASE
- EMITTER
- COLLECTOR

### SOLDERING FOOTPRINT\*

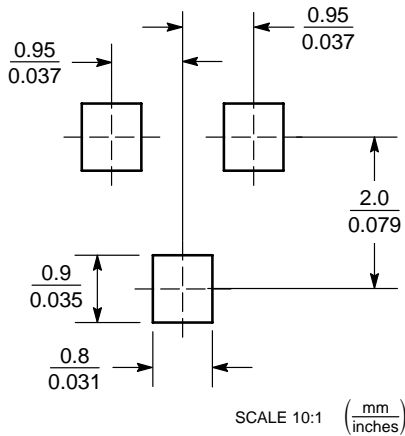

\*For additional information on our Pb-Free strategy and soldering details, please download the ON Semiconductor Soldering and Mounting Techniques Reference Manual, SOLDERRM/D.

ON Semiconductor and  are registered trademarks of Semiconductor Components Industries, LLC (SCILLC). SCILLC reserves the right to make changes without further notice to any products herein. SCILLC makes no warranty, representation or guarantee regarding the suitability of its products for any particular purpose, nor does SCILLC assume any liability arising out of the application or use of any product or circuit, and specifically disclaims any and all liability, including without limitation special, consequential or incidental damages. "Typical" parameters which may be provided in SCILLC data sheets and/or specifications can and do vary in different applications and actual performance may vary over time. All operating parameters, including "Typicals" must be validated for each customer application by customer's technical experts. SCILLC does not convey any license under its patent rights nor the rights of others. SCILLC products are not designed, intended, or authorized for use as components in systems intended for surgical implant into the body, or other applications intended to support or sustain life, or for any other application in which the failure of the SCILLC product could create a situation where personal injury or death may occur. Should Buyer purchase or use SCILLC products for any such unintended or unauthorized application, Buyer shall indemnify and hold SCILLC and its officers, employees, subsidiaries, affiliates, and distributors harmless against all claims, costs, damages, and expenses, and reasonable attorney fees arising out of, directly or indirectly, any claim of personal injury or death associated with such unintended or unauthorized use, even if such claim alleges that SCILLC was negligent regarding the design or manufacture of the part. SCILLC is an Equal Opportunity/Affirmative Action Employer. This literature is subject to all applicable copyright laws and is not for resale in any manner.

### PUBLICATION ORDERING INFORMATION

LITERATURE FULFILLMENT:

Literature Distribution Center for ON Semiconductor  
P.O. Box 61312, Phoenix, Arizona 85082-1312 USA  
Phone: 480-829-7710 or 800-344-3860 Toll Free USA/Canada  
Fax: 480-829-7709 or 800-344-3867 Toll Free USA/Canada  
Email: orderlit@onsemi.com

N. American Technical Support: 800-282-9855 Toll Free  
USA/Canada

Japan: ON Semiconductor, Japan Customer Focus Center  
2-9-1 Kamimeguro, Meguro-ku, Tokyo, Japan 153-0051  
Phone: 81-3-5773-3850

ON Semiconductor Website: <http://onsemi.com>

Order Literature: <http://www.onsemi.com/litorder>

For additional information, please contact your local Sales Representative.