

# NTF5P03T3

Preferred Device

## Power MOSFET 5.2 Amps, 30 Volts P-Channel SOT-223

### Features

- Ultra Low  $R_{DS(on)}$
- Higher Efficiency Extending Battery Life
- Logic Level Gate Drive
- Miniature SOT-223 Surface Mount Package
- Avalanche Energy Specified

### Applications

- DC-DC Converters
- Power Management
- Motor Controls
- Inductive Loads
- Replaces MMFT5P03HD



ON Semiconductor®

<http://onsemi.com>

**5.2 AMPERES**

**30 VOLTS**

**$R_{DS(on)} = 100\text{ m}\Omega$**

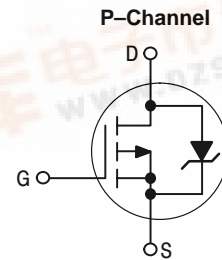

### MARKING DIAGRAM

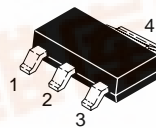

SOT-223  
CASE 318E  
STYLE 3



A = Assembly Location  
 WW = Work Week  
 5P03 = Device Code

### PIN ASSIGNMENT

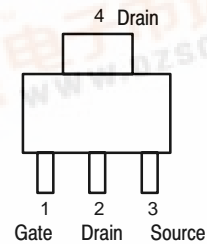

### ORDERING INFORMATION

Device	Package	Shipping
NTF5P03T3	SOT-223	1000 Tape & Reel

## NTF5P03T3

**MAXIMUM RATINGS** ( $T_J = 25^\circ\text{C}$  unless otherwise noted)

Negative sign for P-Channel devices omitted for clarity

Rating		Symbol	Max	Unit
Drain-to-Source Voltage		$V_{DSS}$	-30	V
Drain-to-Gate Voltage ( $R_{GS} = 1.0\text{ M}\Omega$ )		$V_{DGR}$	-30	V
Gate-to-Source Voltage – Continuous		$V_{GS}$	$\pm 20$	V
1" SQ. FR-4 or G-10 PCB  10 seconds	Thermal Resistance – Junction to Ambient	$R_{THJA}$	40	$^\circ\text{C/W}$
	Total Power Dissipation @ $T_A = 25^\circ\text{C}$	$P_D$	3.13	Watts
	Linear Derating Factor		25	$\text{mW}/^\circ\text{C}$
	Drain Current – Continuous @ $T_A = 25^\circ\text{C}$	$I_D$	-5.2	A
10 seconds	Continuous @ $T_A = 70^\circ\text{C}$	$I_D$	-4.1	A
	Pulsed Drain Current (Note 1)	$I_{DM}$	-26	A
	Thermal Resistance – Junction to Ambient		$R_{THJA}$	80
Minimum FR-4 or G-10 PCB  10 seconds	Total Power Dissipation @ $T_A = 25^\circ\text{C}$	$P_D$	1.56	Watts
	Linear Derating Factor		12.5	$\text{mW}/^\circ\text{C}$
	Drain Current – Continuous @ $T_A = 25^\circ\text{C}$	$I_D$	-3.7	A
	Continuous @ $T_A = 70^\circ\text{C}$	$I_D$	-2.9	A
Pulsed Drain Current (Note 1)		$I_{DM}$	-19	A
Operating and Storage Temperature Range		$T_J, T_{stg}$	- 55 to 150	$^\circ\text{C}$
Single Pulse Drain-to-Source Avalanche Energy – Starting $T_J = 25^\circ\text{C}$ ( $V_{DD} = -30\text{ Vdc}$ , $V_{GS} = -10\text{ Vdc}$ , Peak $I_L = -12\text{ Apk}$ , $L = 3.5\text{ mH}$ , $R_G = 25\ \Omega$ )		$E_{AS}$	250	mJ

1. Repetitive rating; pulse width limited by maximum junction temperature.

## NTF5P03T3

### ELECTRICAL CHARACTERISTICS (T<sub>A</sub> = 25°C unless otherwise noted)

Characteristic	Symbol	Min	Typ	Max	Unit
<b>OFF CHARACTERISTICS</b>					
Drain-to-Source Breakdown Voltage (Cpk ≥ 2.0) (Notes 2 and 4) (V <sub>GS</sub> = 0 Vdc, I <sub>D</sub> = -0.25 μAdc) Temperature Coefficient (Positive)	V <sub>(BR)DSS</sub>	-30 -	- -28	- -	Vdc mV/°C
Zero Gate Voltage Drain Current (V <sub>DS</sub> = -24 Vdc, V <sub>GS</sub> = 0 Vdc) (V <sub>DS</sub> = -24 Vdc, V <sub>GS</sub> = 0 Vdc, T <sub>J</sub> = 125°C)	I <sub>DSS</sub>	- -	- -	-1.0 -25	μAdc
Gate-Body Leakage Current (V <sub>GS</sub> = ± 20 Vdc, V <sub>DS</sub> = 0 Vdc)	I <sub>GSS</sub>	-	-	± 100	nAdc

### ON CHARACTERISTICS (Note 2)

Gate Threshold Voltage (Cpk ≥ 2.0) (Notes 2 and 4) (V <sub>DS</sub> = V <sub>GS</sub> , I <sub>D</sub> = -0.25 μAdc) Threshold Temperature Coefficient (Negative)	V <sub>GS(th)</sub>	-1.0 -	-1.75 3.5	-3.0 -	Vdc mV/°C
Static Drain-to-Source On-Resistance (Cpk ≥ 2.0) (Notes 2 and 4) (V <sub>GS</sub> = -10 Vdc, I <sub>D</sub> = -5.2 Adc) (V <sub>GS</sub> = -4.5 Vdc, I <sub>D</sub> = -2.6 Adc)	R <sub>DS(on)</sub>	-	76 107	100 150	mΩ
Forward Transconductance (Note 2) (V <sub>DS</sub> = -15 Vdc, I <sub>D</sub> = -2.0 Adc)	g <sub>fs</sub>	2.0	3.9	-	Mhos

### DYNAMIC CHARACTERISTICS

Input Capacitance	(V <sub>DS</sub> = -25 Vdc, V <sub>GS</sub> = 0 V, f = 1.0 MHz)	C <sub>iss</sub>	-	500	950	pF
Output Capacitance		C <sub>oss</sub>	-	153	440	
Transfer Capacitance		C <sub>rss</sub>	-	58	140	

### SWITCHING CHARACTERISTICS (Note 3)

Turn-On Delay Time	(V <sub>DD</sub> = -15 Vdc, I <sub>D</sub> = -4.0 Adc, V <sub>GS</sub> = -10 Vdc, R <sub>G</sub> = 6.0 Ω) (Note 2)	t <sub>d(on)</sub>	-	10	24	ns
Rise Time		t <sub>r</sub>	-	33	48	
Turn-Off Delay Time		t <sub>d(off)</sub>	-	38	94	
Fall Time		t <sub>f</sub>	-	20	92	
Turn-On Delay Time	(V <sub>DD</sub> = -15 Vdc, I <sub>D</sub> = -2.0 Adc, V <sub>GS</sub> = -10 Vdc, R <sub>G</sub> = 6.0 Ω) (Note 2)	t <sub>d(on)</sub>	-	16	38	ns
Rise Time		t <sub>r</sub>	-	45	110	
Turn-Off Delay Time		t <sub>d(off)</sub>	-	23	60	
Fall Time		t <sub>f</sub>	-	24	80	
Gate Charge	(V <sub>DS</sub> = -24 Vdc, I <sub>D</sub> = -4.0 Adc, V <sub>GS</sub> = -10 Vdc) (Note 2)	Q <sub>T</sub>	-	15	38	nC
		Q <sub>1</sub>	-	1.6	-	
		Q <sub>2</sub>	-	3.5	-	
		Q <sub>3</sub>	-	2.6	-	

### SOURCE-DRAIN DIODE CHARACTERISTICS

Forward On-Voltage	(I <sub>S</sub> = -4.0 Adc, V <sub>GS</sub> = 0 Vdc) (I <sub>S</sub> = -4.0 Adc, V <sub>GS</sub> = 0 Vdc, T <sub>J</sub> = 125°C) (Note 2)	V <sub>SD</sub>	- -	-1.1 -0.89	-1.5 -	Vdc
Reverse Recovery Time	(I <sub>S</sub> = -4.0 Adc, V <sub>GS</sub> = 0 Vdc, dI <sub>S</sub> /dt = 100 A/μs) (Note 2)	t <sub>rr</sub>	-	34	-	ns
		t <sub>a</sub>	-	20	-	
		t <sub>b</sub>	-	14	-	
Reverse Recovery Stored Charge		Q <sub>RR</sub>	-	0.036	-	μC

- Pulse Test: Pulse Width ≤ 300 μs, Duty Cycle ≤ 2.0%.
  - Switching characteristics are independent of operating junction temperatures.
  - Reflects typical values.
- $$C_{pk} = \left| \frac{\text{Max limit} - \text{Typ}}{3 \times \text{SIGMA}} \right|$$

# NTF5P03T3

## TYPICAL ELECTRICAL CHARACTERISTICS

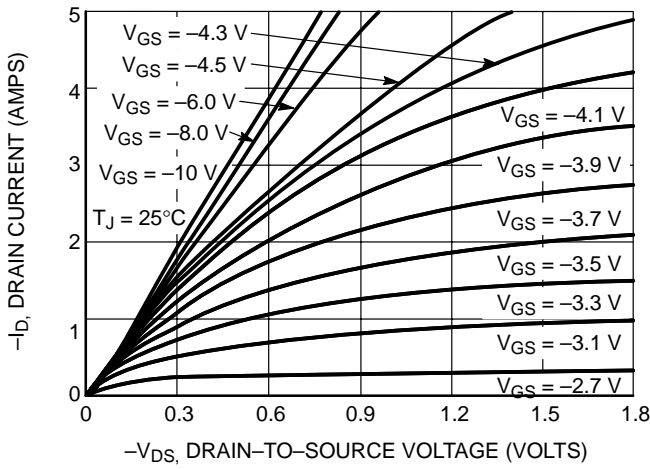

Figure 1. On-Region Characteristics

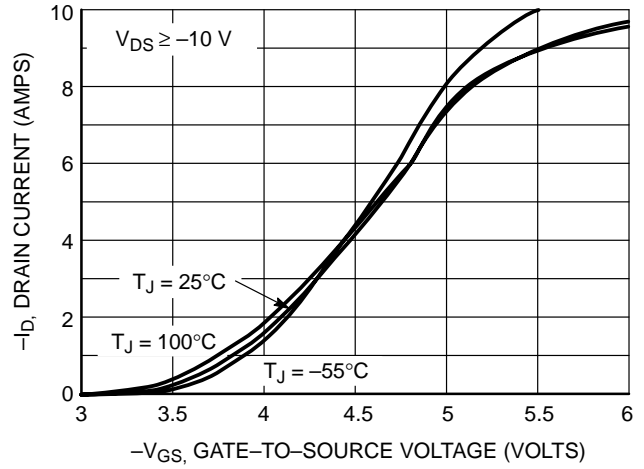

Figure 2. Transfer Characteristics

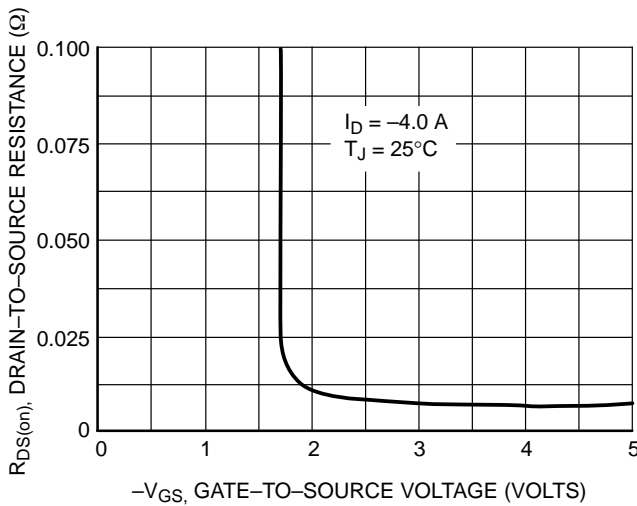

Figure 3. On-Resistance versus Gate-to-Source Voltage

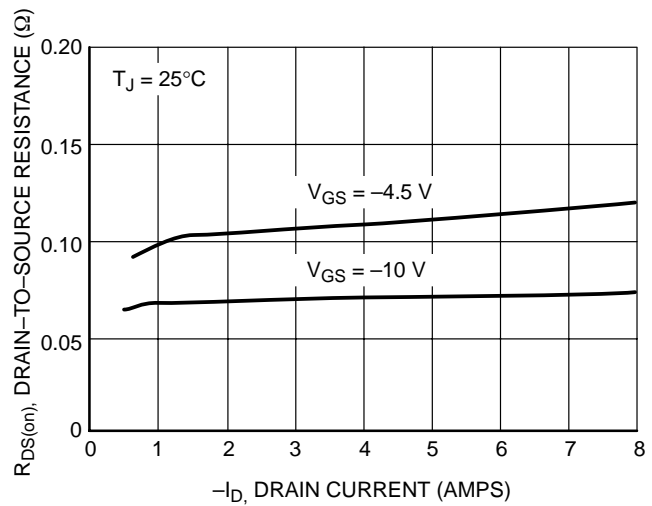

Figure 4. On-Resistance versus Drain Current and Gate Voltage

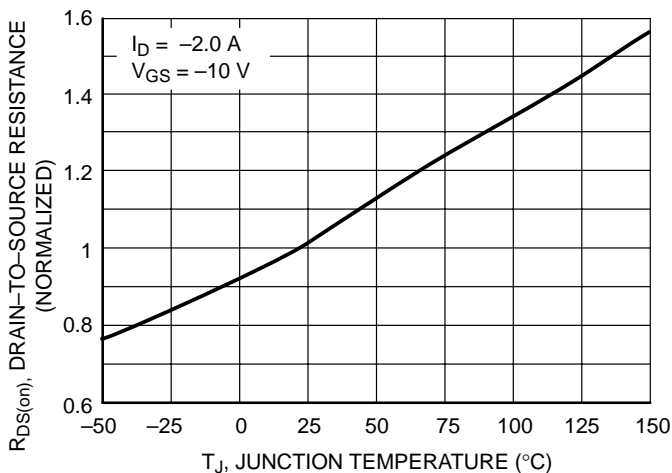

Figure 5. On-Resistance Variation with Temperature

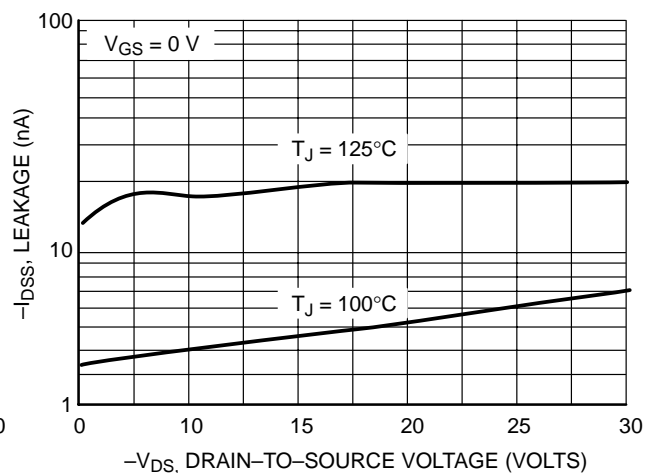

Figure 6. Drain-to-Source Leakage Current versus Voltage

# NTF5P03T3

## TYPICAL ELECTRICAL CHARACTERISTICS

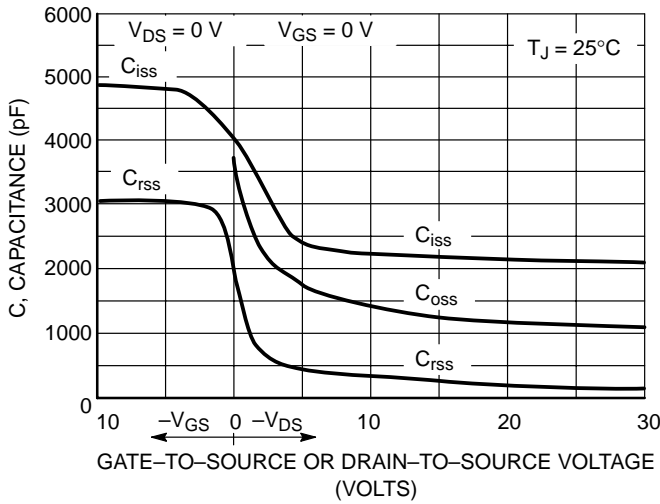

Figure 7. Capacitance Variation

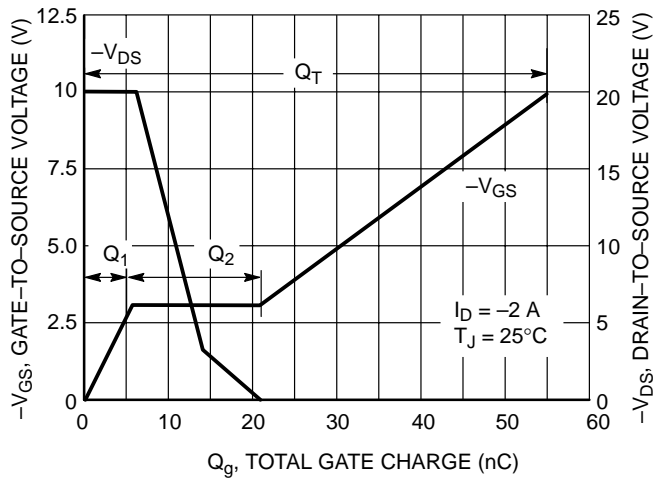

Figure 8. Gate-to-Source and Drain-to-Source Voltage versus Total Charge

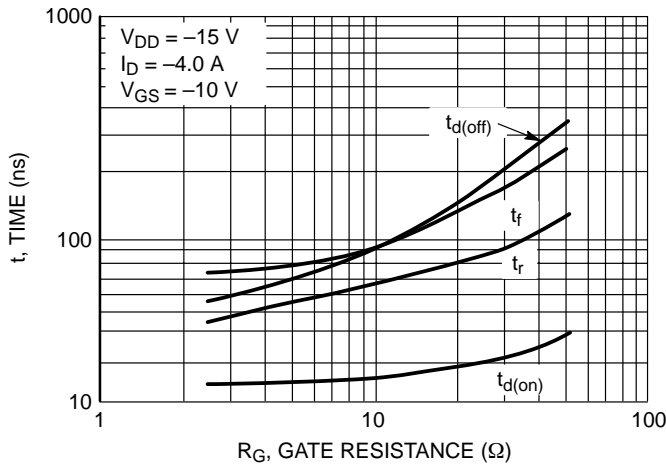

Figure 9. Resistive Switching Time Variation versus Gate Resistance

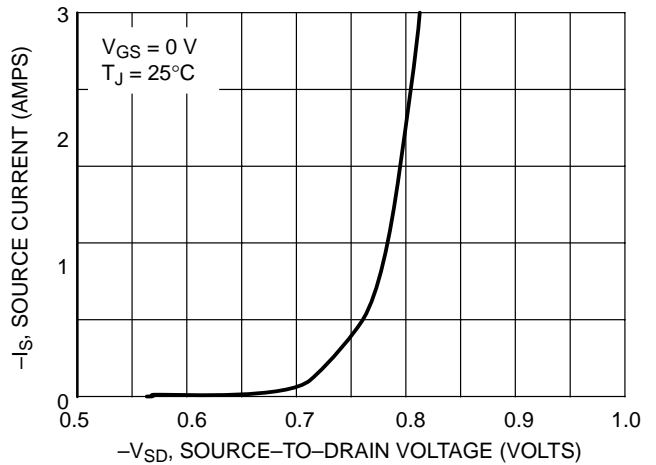
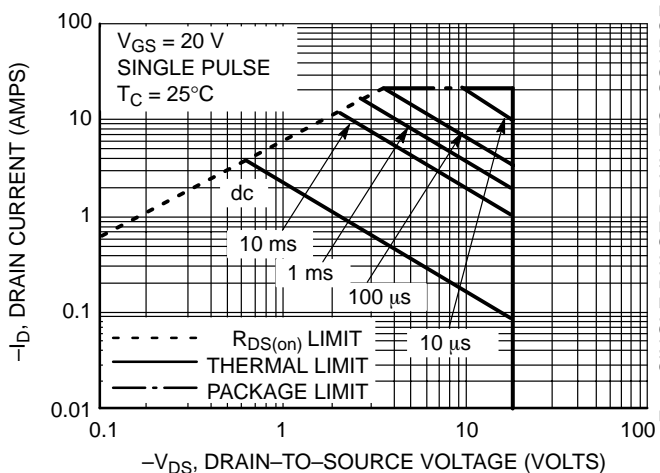

Figure 10. Diode Forward Voltage versus Current



Mounted on 2"sq. FR4 board (1"sq. 2 oz. Cu 0.06" thick single sided) with on die operating, 10 s max.

Figure 11. Maximum Rated Forward Biased Safe Operating Area

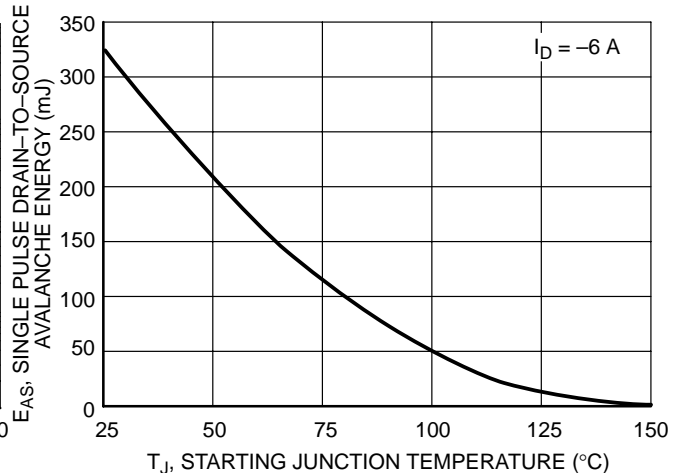

Figure 12. Maximum Avalanche Energy versus Starting Junction Temperature

# NTF5P03T3

## TYPICAL ELECTRICAL CHARACTERISTICS

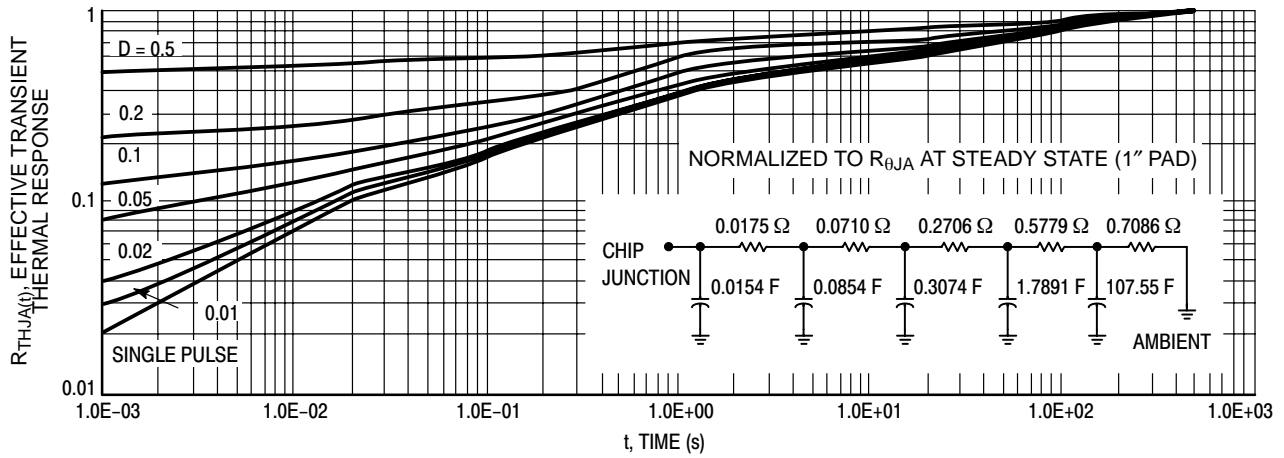

Figure 13. FET Thermal Response

## INFORMATION FOR USING THE SOT-223 SURFACE MOUNT PACKAGE

### MINIMUM RECOMMENDED FOOTPRINT FOR SURFACE MOUNTED APPLICATIONS

Surface mount board layout is a critical portion of the total design. The footprint for the semiconductor packages must be the correct size to insure proper solder connection

interface between the board and the package. With the correct pad geometry, the packages will self align when subjected to a solder reflow process.

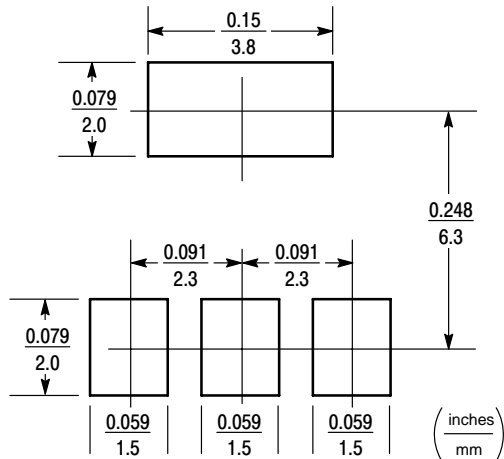

## NTF5P03T3

### TYPICAL SOLDER HEATING PROFILE

For any given circuit board, there will be a group of control settings that will give the desired heat pattern. The operator must set temperatures for several heating zones and a figure for belt speed. Taken together, these control settings make up a heating "profile" for that particular circuit board. On machines controlled by a computer, the computer remembers these profiles from one operating session to the next. Figure 14 shows a typical heating profile for use when soldering a surface mount device to a printed circuit board. This profile will vary among soldering systems, but it is a good starting point. Factors that can affect the profile include the type of soldering system in use, density and types of components on the board, type of solder used, and the type of board or substrate material being used. This profile shows

temperature versus time. The line on the graph shows the actual temperature that might be experienced on the surface of a test board at or near a central solder joint. The two profiles are based on a high density and a low density board. The Vitronics SMD310 convection/infrared reflow soldering system was used to generate this profile. The type of solder used was 62/36/2 Tin Lead Silver with a melting point between 177–189°C. When this type of furnace is used for solder reflow work, the circuit boards and solder joints tend to heat first. The components on the board are then heated by conduction. The circuit board, because it has a large surface area, absorbs the thermal energy more efficiently, then distributes this energy to the components. Because of this effect, the main body of a component may be up to 30 degrees cooler than the adjacent solder joints.

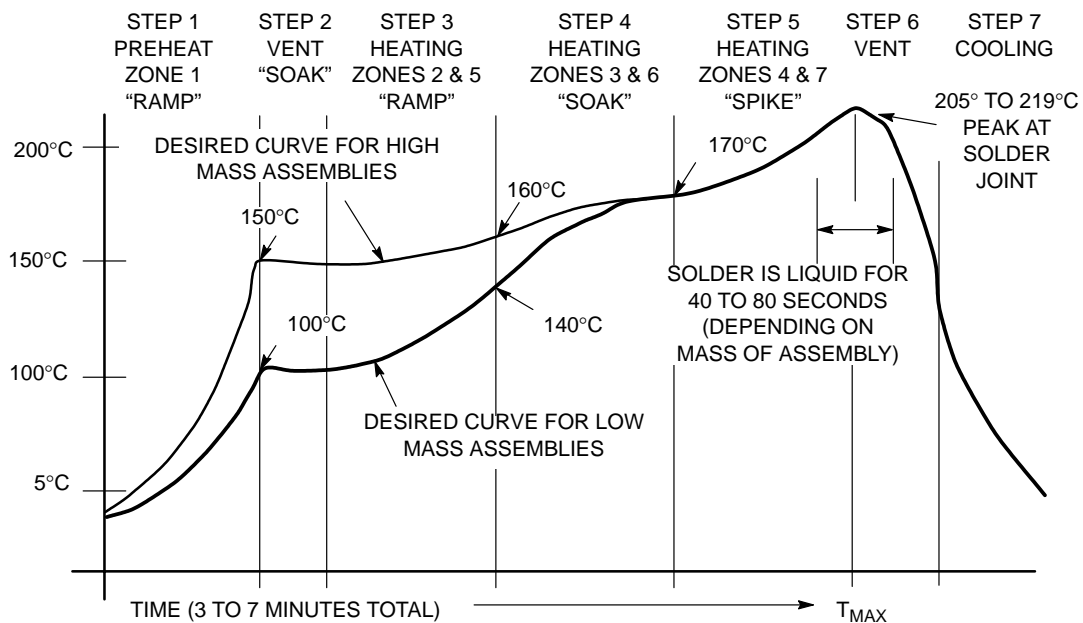
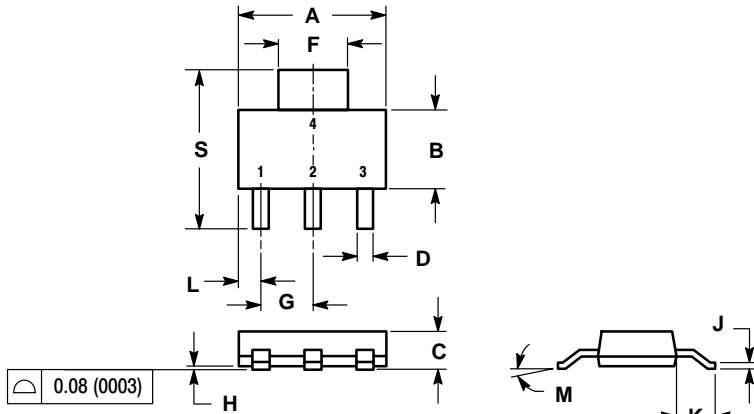

Figure 14. Typical Solder Heating Profile

# NTF5P03T3

## PACKAGE DIMENSIONS

SOT-223 (TO-261)  
CASE 318E-04  
ISSUE K



NOTES:

1. DIMENSIONING AND TOLERANCING PER ANSI Y14.5M, 1982.
2. CONTROLLING DIMENSION: INCH.

DIM	INCHES		MILLIMETERS	
	MIN	MAX	MIN	MAX
A	0.249	0.263	6.30	6.70
B	0.130	0.145	3.30	3.70
C	0.060	0.068	1.50	1.75
D	0.024	0.035	0.60	0.89
F	0.115	0.126	2.90	3.20
G	0.087	0.094	2.20	2.40
H	0.0008	0.0040	0.020	0.100
J	0.009	0.014	0.24	0.35
K	0.060	0.078	1.50	2.00
L	0.033	0.041	0.85	1.05
M	0°	10°	0°	10°
S	0.264	0.287	6.70	7.30

STYLE 3:

- PIN 1. GATE
- DRAIN
- SOURCE
- DRAIN

ON Semiconductor and are registered trademarks of Semiconductor Components Industries, LLC (SCILLC). SCILLC reserves the right to make changes without further notice to any products herein. SCILLC makes no warranty, representation or guarantee regarding the suitability of its products for any particular purpose, nor does SCILLC assume any liability arising out of the application or use of any product or circuit, and specifically disclaims any and all liability, including without limitation special, consequential or incidental damages. "Typical" parameters which may be provided in SCILLC data sheets and/or specifications can and do vary in different applications and actual performance may vary over time. All operating parameters, including "Typicals" must be validated for each customer application by customer's technical experts. SCILLC does not convey any license under its patent rights nor the rights of others. SCILLC products are not designed, intended, or authorized for use as components in systems intended for surgical implant into the body, or other applications intended to support or sustain life, or for any other application in which the failure of the SCILLC product could create a situation where personal injury or death may occur. Should Buyer purchase or use SCILLC products for any such unintended or unauthorized application, Buyer shall indemnify and hold SCILLC and its officers, employees, subsidiaries, affiliates, and distributors harmless against all claims, costs, damages, and expenses, and reasonable attorney fees arising out of, directly or indirectly, any claim of personal injury or death associated with such unintended or unauthorized use, even if such claim alleges that SCILLC was negligent regarding the design or manufacture of the part. SCILLC is an Equal Opportunity/Affirmative Action Employer.

### PUBLICATION ORDERING INFORMATION

**Literature Fulfillment:**

Literature Distribution Center for ON Semiconductor  
P.O. Box 5163, Denver, Colorado 80217 USA  
**Phone:** 303-675-2175 or 800-344-3860 Toll Free USA/Canada  
**Fax:** 303-675-2176 or 800-344-3867 Toll Free USA/Canada  
**Email:** ONlit@hibbertco.com

**N. American Technical Support:** 800-282-9855 Toll Free USA/Canada

**JAPAN:** ON Semiconductor, Japan Customer Focus Center  
4-32-1 Nishi-Gotanda, Shinagawa-ku, Tokyo, Japan 141-0031  
**Phone:** 81-3-5740-2700  
**Email:** r14525@onsemi.com

**ON Semiconductor Website:** <http://onsemi.com>

For additional information, please contact your local Sales Representative.