

Product Bulletin OH360U
May 1996

Hallogic® Hall Effect Sensors Type OH360U

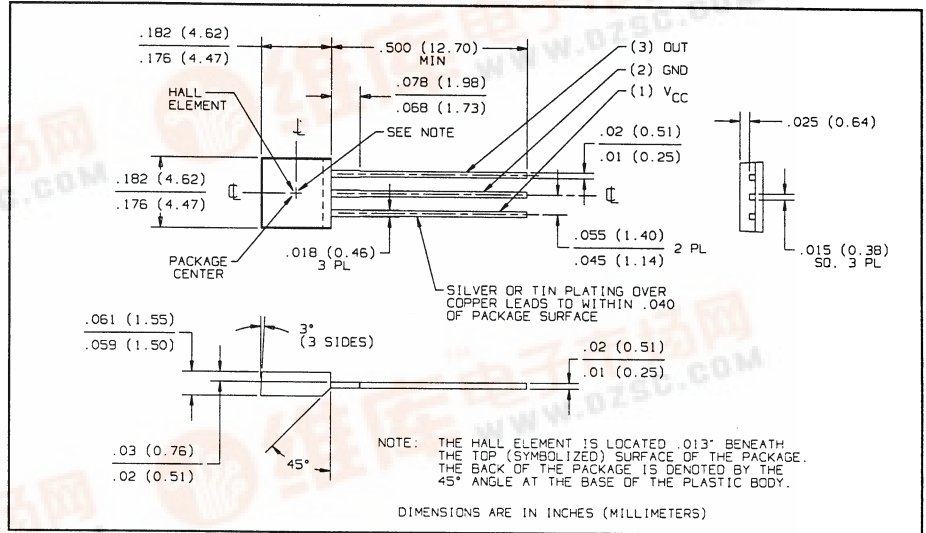
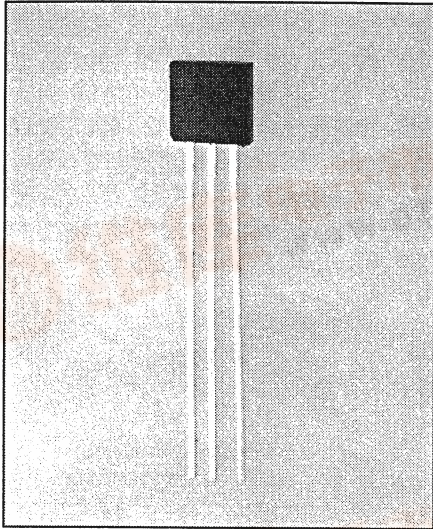

Features

- Operates over a broad range of supply voltages
- Excellent temperature stability to operate in harsh environments
- Drive capability up to 10 TTL loads
- Hall element, linear amplifier, and Schmitt trigger on a single Hallogic® silicon chip

Description

The OH360U contains a monolithic integrated circuit which incorporates a Hall element, a linear amplifier, a threshold amplifier, and Schmitt trigger on a single silicon chip. Included on-chip is a bandgap voltage regulator to allow operation with a wide range of supply voltages. The device features logic level output and provides up to 30 mA of sink current. This allows direct driving of more than 10 TTL loads or any standard logic family using power supplies ranging from 4.5 to 24 volts. Output amplitude is constant at switching frequencies from DC to over 200 kHz.

The OH360U is a high performance device capable of operation from -40° C to +150° C. Stability of the magnetic operate and release points is excellent over this entire temperature range.

Package size has been kept to minimum, providing an advantage in applications where space is limited.

Absolute Maximum Ratings (T_A = 25° C unless otherwise noted)

Supply Voltage, V _{CC}	25 V
Storage Temperature Range, T _S	-65° C to +160° C
Operating Temperature Range, T _A	-40° C to +150° C
Lead Soldering Temperature [1/8 inch (3.2 mm) from case for 5 sec. with soldering iron].....	260° C ⁽¹⁾
Output ON Current, I _{SINK}	50 mA
Output OFF Voltage, V _{OUT}	25 V
Magnetic Flux Density, B.....	Unlimited

Note:

(1) Heat sink leads during hand soldering.

Functional Block Diagram

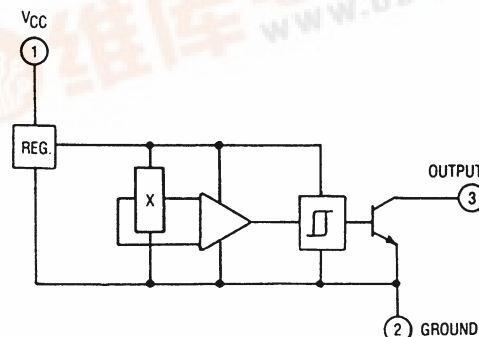

Type OH360U

Electrical Characteristics ($V_{CC} = 4.5 \text{ V to } 24 \text{ VDC}$, $T_A = 25^\circ \text{ C}$ unless otherwise noted)

SYMBOL	PARAMETER	MIN	TYP	MAX	UNITS	TEST CONDITIONS
BOP	Magnetic Operate Point ⁽²⁾	235	300	465	Gauss	
BRP	Magnetic Release Point	120	235	325	Gauss	
BH	Magnetic Hysteresis	30	65	200	Gauss	
I _{CC}	Supply Current		6	9	mA	$V_{CC} = 24 \text{ V}$, Output On
V _{OL}	Output Saturation Voltage		100	300	mV	$V_{CC} = 4.5 \text{ V}$, $I_{OL} = 30 \text{ mA}$
I _{OH}	Output Leakage Current		0.1	10.0	μA	$V_{CC} = 24 \text{ V}$, $V_{OUT} = 24 \text{ V}$
t _r	Output Rise Time		0.3	1.00	μs	$R_L = 820 \Omega$, $C_L = 20 \text{ pF}$, $V_{CC} = 14.0 \text{ V}$
t _f	Output Fall Time		0.3	1.00	μs	

(2) South pole facing symbolized surface.

Typical Performance Curves

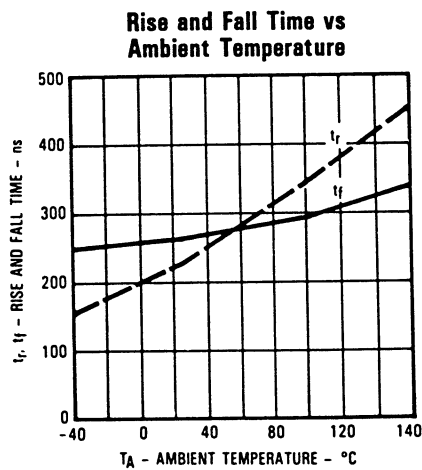
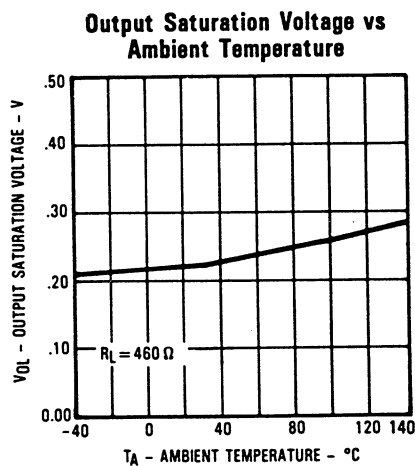
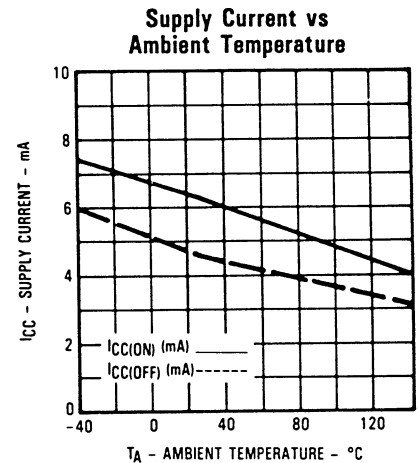
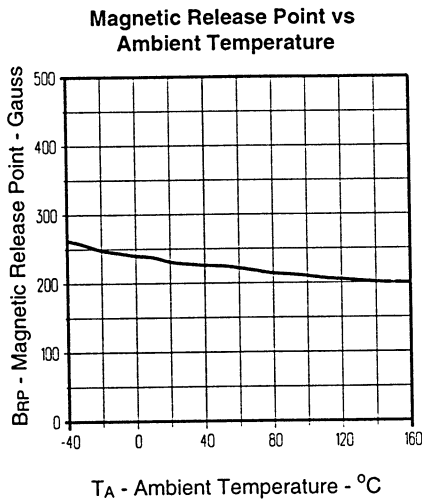
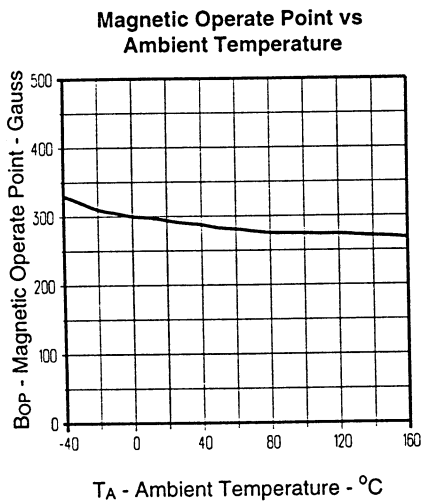

Rise and Fall Time Tests

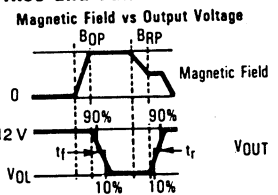

Rise and Fall Time Test Circuit

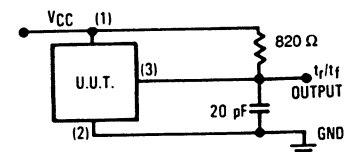

HALL EFFECT SENSORS