

Product Bulletin OHN3013U
May 1996

Hallogic[®] Hall Effect Sensors Type OHN3013U

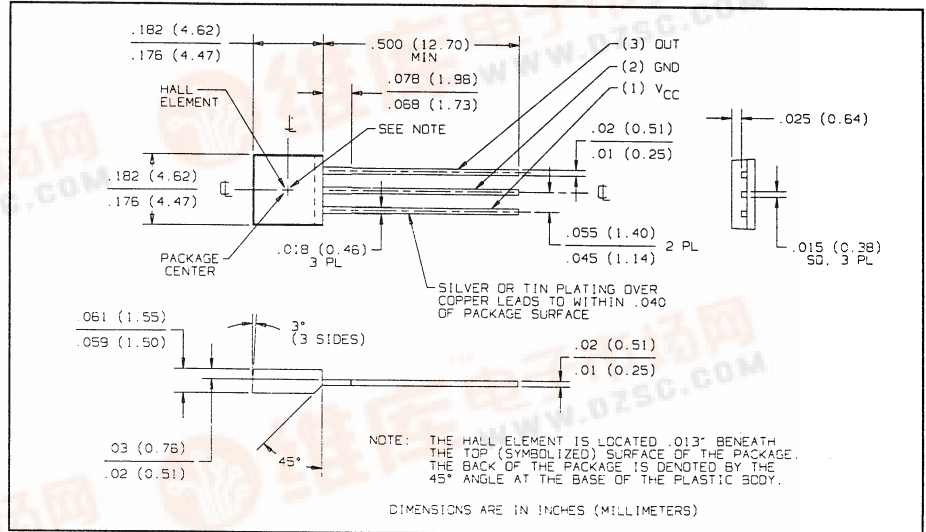
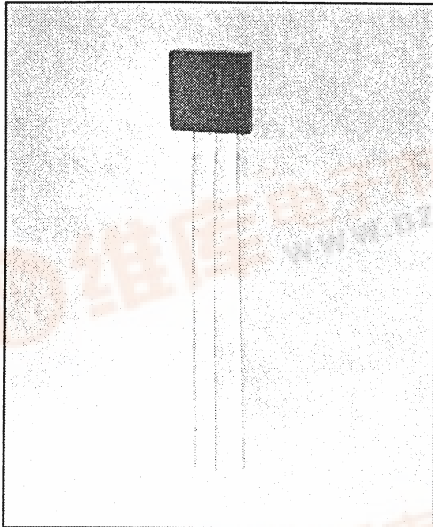

Features

- Operates over a broad range of supply voltages
- Excellent temperature stability to operate in harsh environments
- Drive capability up to 7 TTL loads
- Hall element, linear amplifier, and Schmitt trigger on a single Hallogic[®] silicon chip

Description

The OHN3013U contains a monolithic integrated circuit which incorporates a Hall element, a linear amplifier, and Schmitt trigger on a single silicon chip. Included on-chip is a bandgap voltage regulator to allow operation with a wide range of supply voltages. The device features logic level output and provides up to 21 mA of sink current. This allows direct driving of more than 7 TTL loads or any standard logic family using power supplies ranging from 4.5 to 24 volts. Output amplitude is constant at switching frequencies from DC to over 200 kHz.

Stability of the magnetic operate and release points is excellent over this entire temperature range. The release point over the temperature range will always be greater than zero gauss.

Package size has been kept to minimum, providing an advantage in applications where space is limited.

Absolute Maximum Ratings (T_A = 25^o C unless otherwise noted)

Supply Voltage, V _{CC}	25 V
Storage Temperature Range, T _S	-65 ^o C to +150 ^o C
Operating Temperature Range, T _A	-20 ^o C to +85 ^o C
Lead Soldering Temperature [1/8 inch (3.2 mm) from case for 5 sec. with soldering iron]	260 ^o C ⁽¹⁾
Output ON Current, I _{SINK}	25 mA
Output OFF Voltage, V _{OUT}	25 V
Magnetic Flux Density, B	Unlimited

Note:

(1) Heat sink leads during hand soldering.

Functional Block Diagram

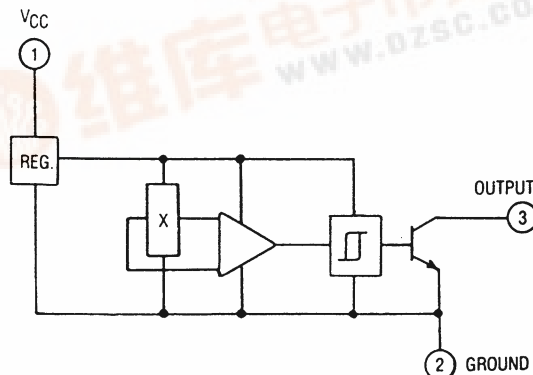

Type OHN3013U

Electrical Characteristics ($V_{CC} = 4.5 \text{ V to } 24 \text{ VDC}$, $T_A = 25^\circ \text{ C}$ unless otherwise noted)

SYMBOL	PARAMETER	MIN	TYP	MAX	UNITS	TEST CONDITIONS
BOP	Magnetic Operate Point ⁽²⁾		300	450	Gauss	
BRP	Magnetic Release Point	25	235		Gauss	
B _H	Magnetic Hysteresis	30	65		Gauss	
I _{CC}	Supply Current		4	7	mA	$V_{CC} = 24 \text{ V}$, Output Off
V _{OL}	Output Saturation Voltage		100	400	mV	$V_{CC} = 4.5 \text{ V}$, $I_{OL} = 20 \text{ mA}$, $B \geq 450 \text{ Gauss}$
I _{OH}	Output Leakage Current		0.1	10.0	μA	$V_{CC} = 24 \text{ V}$, $V_{OUT} = 24 \text{ V}$, $B \leq 25 \text{ Gauss}$
t _r	Output Rise Time		0.21	1.00	μs	$R_L = 820 \Omega$, $C_L = 20 \text{ pF}$
t _f	Output Fall Time		0.25	1.00	μs	

(2) South pole facing symbolized surface.

Typical Performance Curves

Magnetic Operate Point vs Ambient Temperature

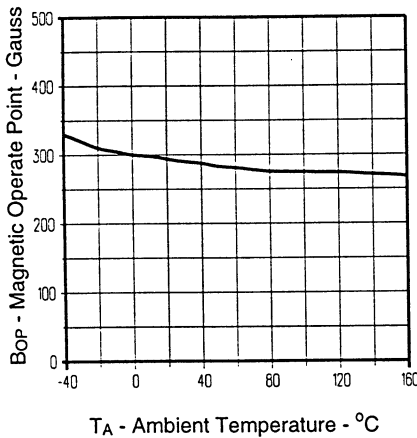

Magnetic Release Point vs Ambient Temperature

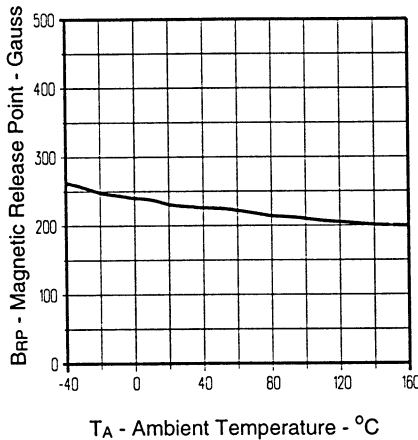

Supply Current vs Ambient Temperature

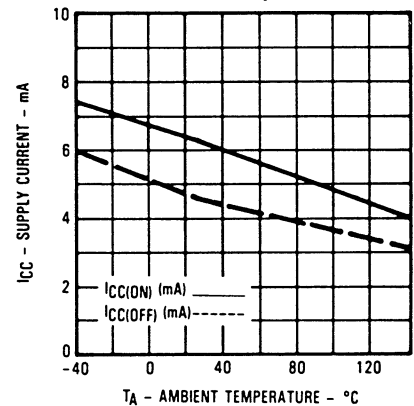

Output Saturation Voltage vs Ambient Temperature

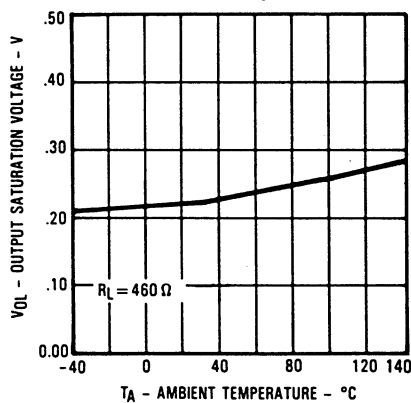

Rise and Fall Time vs Ambient Temperature

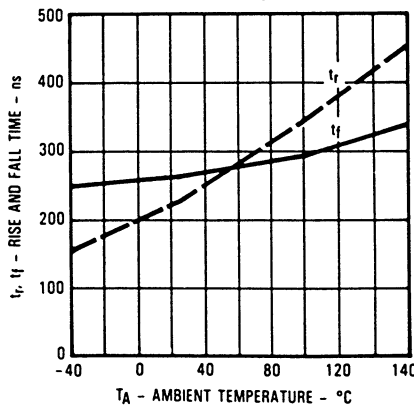

Rise and Fall Time Tests

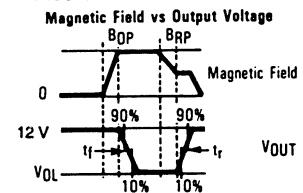

Rise and Fall Time Test Circuit

