

## FEATURES

- 2.5 GHz Bandwidth
- 4.0 kΩ Differential Transimpedance
- 10 pA/√Hz Typical Input Referred Noise
- 2 mA Maximum Input Current
- Offset Cancellation
- Received Signal Strength Indication
- Differential CML Data Outputs
- Single +3.3V Supply
- Bare-Die Option

## APPLICATIONS

- SONET OC-48
- SDH STM-16
- APD Preamplifier-Receivers
- PIN Preamplifier-Receivers

## DESCRIPTION

The ONET2511TA is a high-speed transimpedance amplifier used in SDH/SONET systems with data rates up to 2.5Gbps. It features a low input referred noise, 2.5GHz bandwidth, 4.0kΩ transimpedance, and a received signal strength indicator.

The ONET2511TA device is available in die form and requires a single +3.3V supply. It is very power efficient and dissipates less than 83 mW (typical). It is characterized for operations from –40°C to 85°C.

## AVAILABLE OPTIONS

T <sub>A</sub>	DIE
–40°C to 85°C	ONET2511TAY

## DETAILED DESCRIPTION

### BLOCKDIAGRAM

The ONET2511TA is a high performance 2.5 Gbps transimpedance amplifier that can be segmented into the signal path, filter, and offset cancellation block.

The signal path consists of a transimpedance amplifier stage, a voltage amplifier, and an output buffer.

The filter circuit provides a filtered VCC for the photodiode.

The offset correction circuit uses an internal low pass filter to cancel the DC on the input and it provides a signal to monitor the received signal strength.

A simplified block diagram of the ONET2511TA is shown in Figure 1.

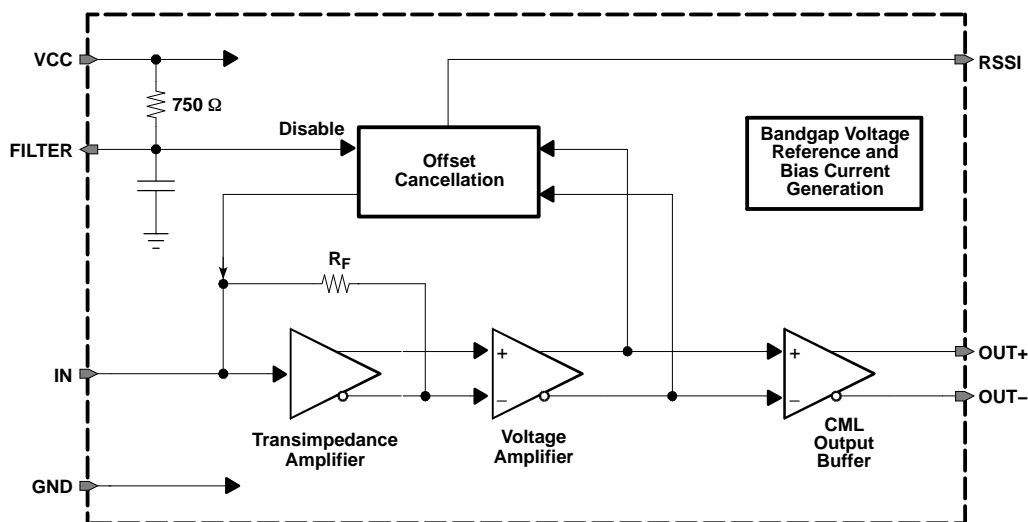

Figure 1. Simplified Block Diagram of the ONET2511TA



Please be aware that an important notice concerning availability, standard warranty, and use in critical applications of Texas Instruments semiconductor products and disclaimers thereto appears at the end of this data sheet.

**DETAILED DESCRIPTION (continued)**

**SIGNAL PATH**

The first stage of the signal path is a transimpedance amplifier that takes the photodiode current and converts it to a voltage signal. The second stage is a voltage amplifier that provides additional gain. The output of the second stage feeds the output buffer and the offset cancellation circuitry. The third and final signal path stage of the ONET2511TA is the output buffer. The output buffer provides CML outputs with an on-chip 50Ω back-termination to VCC.

**FILTER CIRCUITRY**

The filter pin provides a filtered VCC for the photodiode bias. The on-chip low pass filter for the photodiode VCC is implemented using a filter resistor of 750Ω and an internal capacitor. If additional filtering is required for the application, an external capacitor should be connected to the FILTER pin.

**OFFSET CANCELLATION AND RSSI**

The offset cancellation circuitry performs low pass filtering of the output signal of the voltage amplifier. This senses the DC offset at the input of the ONET2511TA. The circuitry subtracts current from the input to effectively cancel the DC. The sensed current is mirrored and is used to generate the RSSI output through an external 10 kΩ resistor. To disable the offset correction loop, the FILTER pin should be tied to GND.

**BOND PAD DESCRIPTION**

The ONET2511TA is available as bare-die. The location of the bondpads is shown in Figure 2. The circuit is characterized for ambient temperatures between –40°C and 85°C. Table 1 shows the pad descriptions for the ONET2511TA.

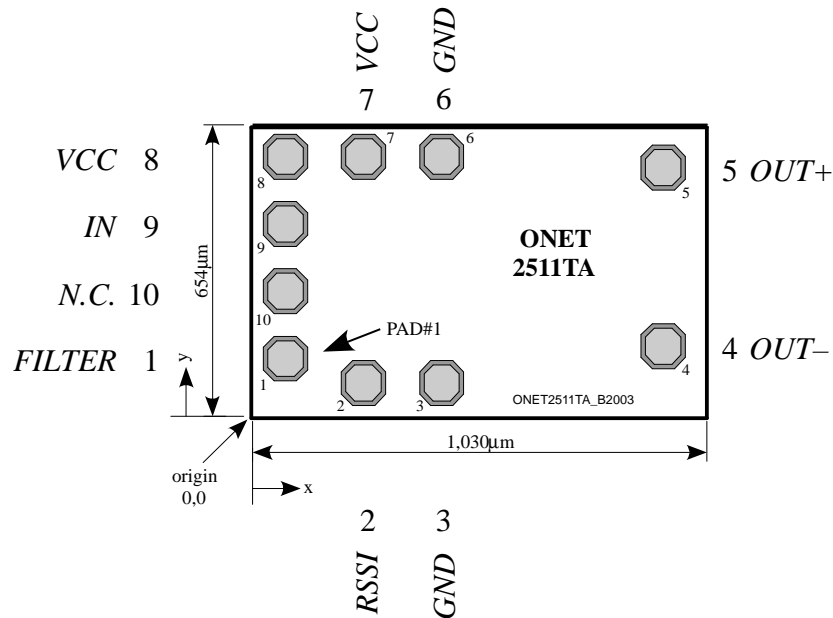

**Figure 2. Bond Pad Assignment of ONET2511TA**

**Table 1. Pad Description of the ONET2511TA**

PAD	SYMBOL	TYPE	DESCRIPTION
1	FILTER	Analog	Bias voltage for photodiode (connects to an internal 750-Ω resistor to V <sub>CC</sub> ). To disable offset correction loop connect FILTER to GND.
2	RSSI	Analog-Out	Analog output voltage proportional to the input data amplitude. Indicates the strength of the received signal (RSSI).
3, 6	GND	Supply	Circuit ground.

**DETAILED DESCRIPTION (continued)**

**Table 1. Pad Description of the ONET2511TA (continued)**

PAD	SYMBOL	TYPE	DESCRIPTION
4	OUT-	Analog-Out	Inverted data output. On-chip 50-Ω back-terminated to $V_{CC}$ .
5	OUT+	Analog-Out	Non-inverted data output. On-chip 50-Ω back-terminated to $V_{CC}$ .
7, 8	VCC	Supply	3.3-V $\pm$ 10% supply voltage
9	IN	Analog-In	Data input to TIA. Connect to anode of PIN or APD diode.
10	NC		Not connected

**ABSOLUTE MAXIMUM RATINGS**

over operating free-air temperature range (unless otherwise noted)<sup>(1)</sup>

			UNIT
$V_{CC}$	Supply voltage <sup>(2)</sup>	-0.3 to 4.0	V
$V_{OUT+}$ $V_{OUT-}$	Voltage of OUT+ and Out- <sup>(2)</sup>	$V_{CC} - 1.5$ to $V_{CC} + 0.5$	V
$V_{FILTER}$ $V_{RSSI}$	Voltage of FILTER and RSSI <sup>(2)</sup>	-0.3 to 4.0	V
$I_{IN}$	Current into IN	-4 to 4	mA
$I_{FILTER}$	Current into FILTER	-8 to 8	mA
ESD	ESD rating at all pins except IN <sup>(3)</sup>	2	kV (HBM)
	ESD rating at IN <sup>(3)</sup>	1	kV (HBM)
$T_{Jmax}$	Maximum junction temperature	150	°C
$T_{STG}$	Storage temperature	-65 to 85	°C
$T_A$	Operating free-air temperature	-40 to 85	°C

(1) Stresses beyond those listed under "absolute maximum ratings" may cause permanent damage to the device. These are stress ratings only, and functional operation of the device at these or any other conditions beyond those indicated under "recommended operating conditions" is not implied. Exposure to absolute–maximum–rated conditions for extended periods may affect device reliability.

(2) All voltage values are with respect to network ground terminal.

(3) For optimum high-frequency performance, the input pin has reduced ESD protection.

**RECOMMENDED OPERATING CONDITIONS**

over operating free-air temperature range (unless otherwise noted)

PARAMETER		TEST CONDITIONS	MIN	NOM	MAX	UNIT
$V_{CC}$	Supply voltage		3	3.3	3.6	V
$T_A$	Operating free-air temperature		-40		85	°C

**DC ELECTRICAL CHARACTERISTICS**

over operating free-air temperature range,  $V_{CC} = 3.3$  V,  $T_A = 25^\circ\text{C}$  (unless otherwise noted)

PARAMETER		TEST CONDITIONS	MIN	TYP	MAX	UNIT
$V_{CC}$	Supply voltage		3	3.3	3.6	V
$I_{CC}$	Supply current			25	35	mA
$V_{IB}$	Input bias voltage		0.66	0.83	1.1	V
$I_{IN-OVL}$	DC input overload current		2			mA
$R_{OUT}$	Output resistance (OUT+, OUT-)	Single-ended to $V_{CC}$		50		Ω
$R_{FILTER}$	Photodiode filter resistance (FILTER)			750		Ω

# ONET2511TA

## 2.5 GBPS TRANSMIMPEDANCE AMPLIFIER WITH RSSI

SLLS622–SEPTEMBER 2004

### AC ELECTRICAL CHARACTERISTICS

over operating free-air temperature range,  $V_{CC} = 3.3\text{ V}$ ,  $T_A = 25^\circ\text{C}$  (unless otherwise noted)

PARAMETER		TEST CONDITIONS	MIN	TYP	MAX	UNIT
$I_{IN-OVL}$	AC input overload current		2			$\text{mA}_{p-p}$
	Input linear range	$0.95 < \text{linearity} < 1.05$		40		$\mu\text{A}_{p-p}$
$A_{RSSI}$	RSSI gain	10-k $\Omega$ load		2000		V/A
$Z_{21}$	Small-signal transimpedance	Differential output	3000	4000	5000	$\Omega$
$f_{H-3dB}$	Small-signal bandwidth	$C_{EXTERNAL} = 0.85\text{ pF}^{(1)}$		2.5		GHz
$f_{L-3dB}$	Low-frequency -3dB bandwidth	-3 dB, $I_{IN} < 20\text{ }\mu\text{A DC}$		7		kHz
$f_{H-3dB-RSSI}$	RSSI bandwidth			4		kHz
$I_{N-IN}$	Input referred RMS noise			470	640	$\text{nA}_{RMS}$
	Input referred noise density			10		$\text{pA}/\sqrt{\text{Hz}}$
DJ	Deterministic jitter	$I_{IN} = 10\text{ }\mu\text{A}$ (K28.5 pattern)		21		$\text{ps}_{p-p}$
		$I_{IN} = 100\text{ }\mu\text{A}$ (K28.5 pattern)		25		$\text{ps}_{p-p}$
		$I_{IN} = 2\text{ mA}$ (K28.5 pattern)		16		$\text{ps}_{p-p}$
$V_{OD(MAX)}$	Differential output voltage, maximum	$I_{IN} = 1\text{ mA}_{p-p}$	200	320	400	$\text{mV}_{p-p}$
PSRR	Power supply rejection ratio	$f < 2\text{ MHz}$		55		dB

(1)  $C_{EXTERNAL}$  is the total capacitance comprising of the photodiode capacitance, board capacitance, and pad capacitance at the IN bondpad.

## APPLICATION INFORMATION

### Basic Application Circuit

Figure 3 shows the ONET2511TA being used as a receiver in a typical fiber optic application. The ONET2511TA converts the electrical current generated by the PIN or APD photodiode into a differential voltage output. The FILTER input provides a DC bias voltage for the photodiode that is low pass filtered by the combination of the internal 750-Ω resistor and internal capacitor. For additional power supply filtering, use an external capacitor  $C_{\text{FILTER}}$ . The RSSI output is used to mirror the photodiode output current and must be connected via a 10-kΩ resistor to GND or left open. Within the ONET2511TA, the OUT+ and OUT- pins are back-terminated with 50 Ω to VCC.

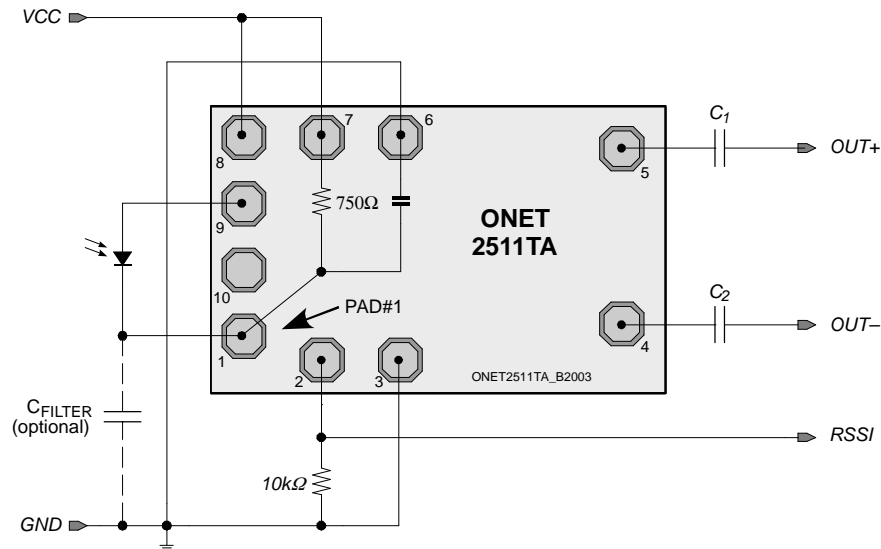

Figure 3. Basic Application Circuit

### Board Layout

Careful attention to board layout parasitics and external components is necessary to achieve optimal performance with a high performance transimpedance amplifier like the ONET2511TA.

Recommendations that optimize performance include:

1. Minimize total capacitance on the IN pad by using a low capacitance photodiode and paying attention to stray capacitances. Place the photodiode close to the ONET2511TA die in order to minimize the bond wire length and thus the parasitic inductance.
2. The external filter capacitance  $C_{\text{FILTER}}$  may have an impact on the transfer function of the TIA and must be chosen with care based on the module implementation.
3. Use identical termination and symmetrical transmission lines at the differential output pins OUT+ and OUT-.
4. Use short bond wire connections for the supply terminals VCC and GND. Provide sufficient supply voltage filtering.

**APPLICATION INFORMATION (continued)**  
**CHIP DIMENSIONS AND PAD LOCATIONS**

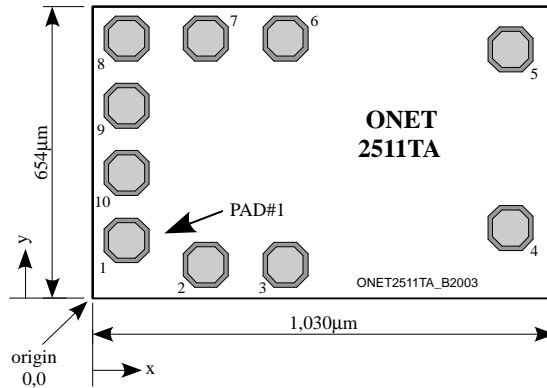

**Figure 4. Chip Dimensions and Pad Locations**

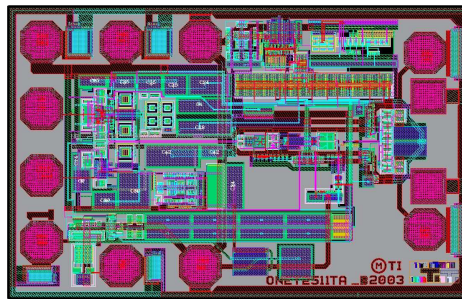

**Figure 5. Chip Layout**

**Pad Locations and Description**

PAD	LOWER LEFT COORDINATE		UPPER RIGHT COORDINATE		SYMBOL	TYPE	DESCRIPTION
	x [µm]	y [µm]	x [µm]	y [µm]			
1	30	84	115	169	FILTER	Analog	Bias voltage for photodiode
2	207	30	292	115	RSSI	Analog out	RSSI output voltage signal
3	384	30	469	115	GND	Supply	Circuit ground
4	886	112	971	197	OUT-	Analog out	Inverted data output
5	886	509	971	594	OUT+	Analog out	Non-inverted data output
6	384	534	469	619	GND	Supply	Circuit ground
7	207	534	292	619	VCC	Supply	+3.3 V ± 10% supply voltage
8	30	534	115	619	VCC	Supply	+3.3 V ± 10% supply voltage
9	30	384	115	469	IN	Analog in	Data input to TIA
10	30	234	115	319	NC		Not connected

### TO46 Layout Example

An example for a suggested layout in a 5-pin TO46 ROSA is given in Figure 6 (top view).

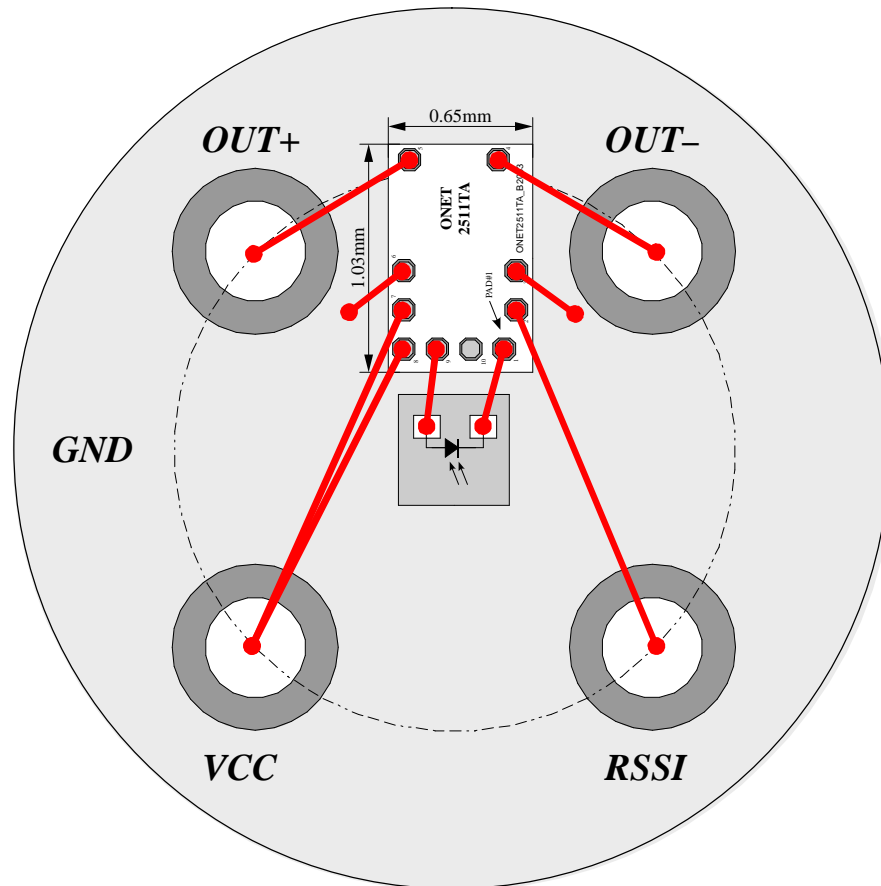

Figure 6. TO46 Layout Example Using the ONET2511TA

**TYPICAL CHARACTERISTICS**

$V_{CC} = +3.3\text{ V}$  and  $T_A = +25^\circ\text{C}$  (unless otherwise noted)

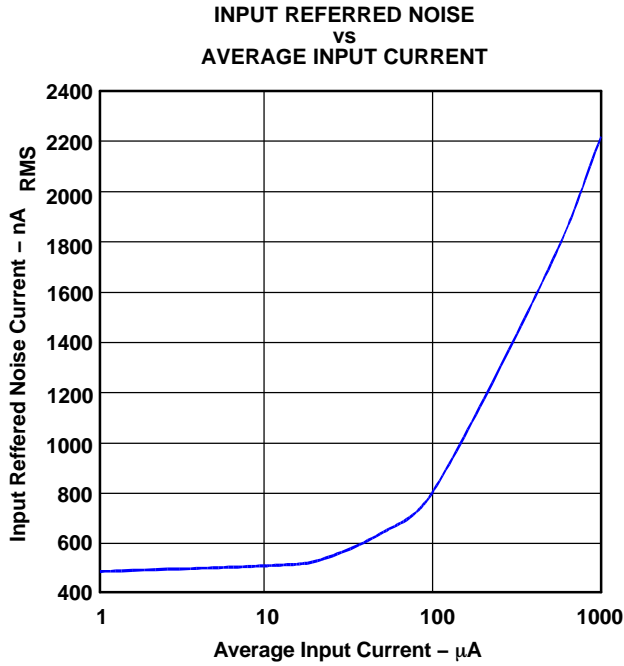

Figure 7.

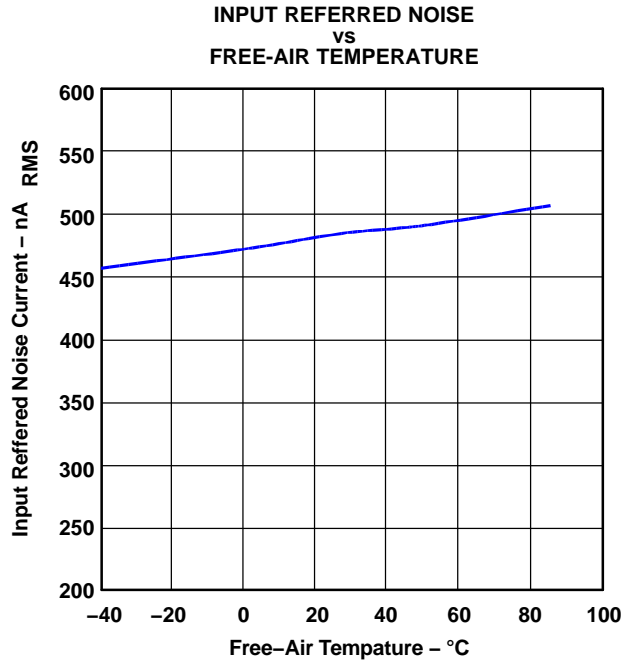

Figure 8.

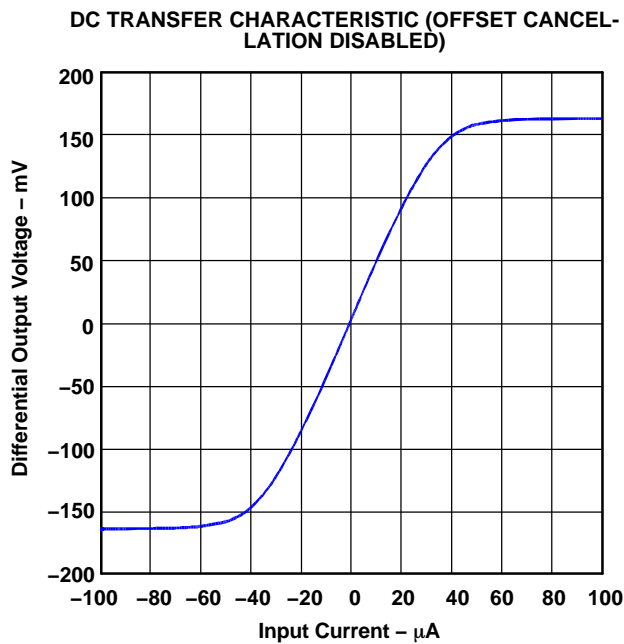

Figure 9.

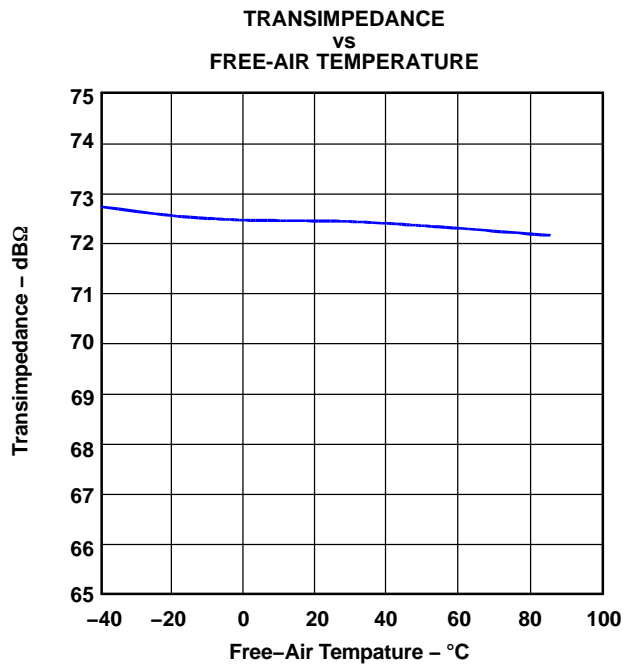

Figure 10.



**TYPICAL CHARACTERISTICS (continued)**

$V_{CC} = +3.3\text{ V}$  and  $T_A = +25^\circ\text{C}$  (unless otherwise noted)

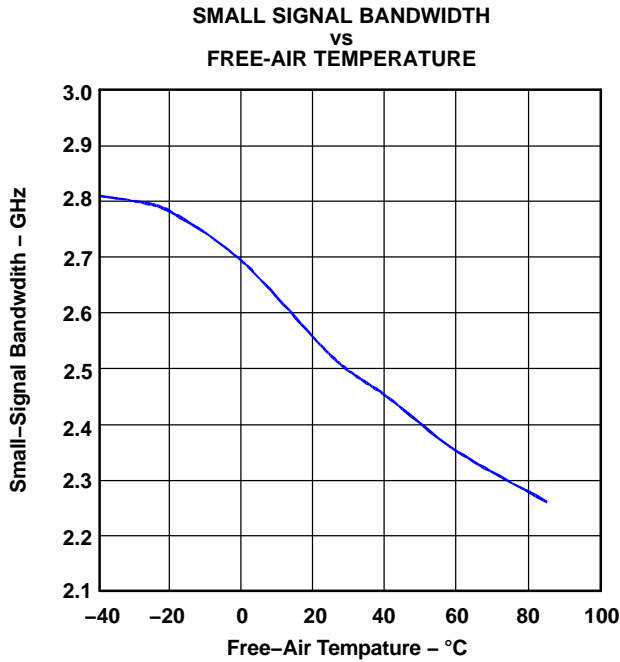

Figure 11.

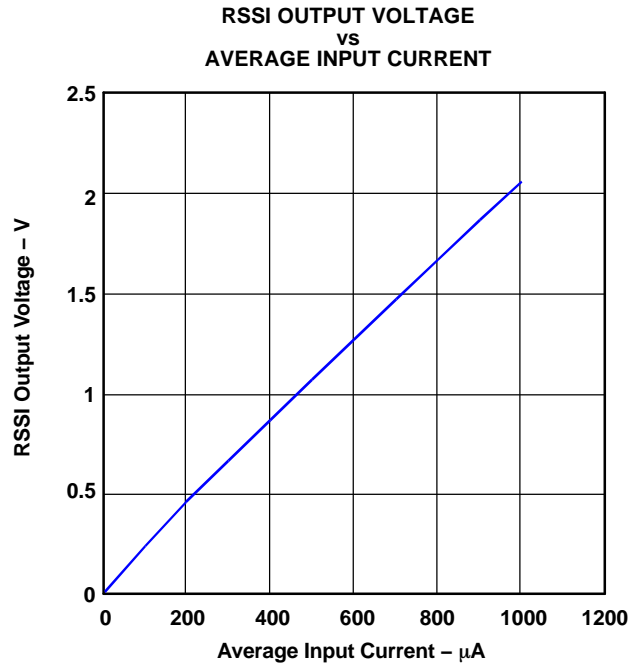

Figure 12.

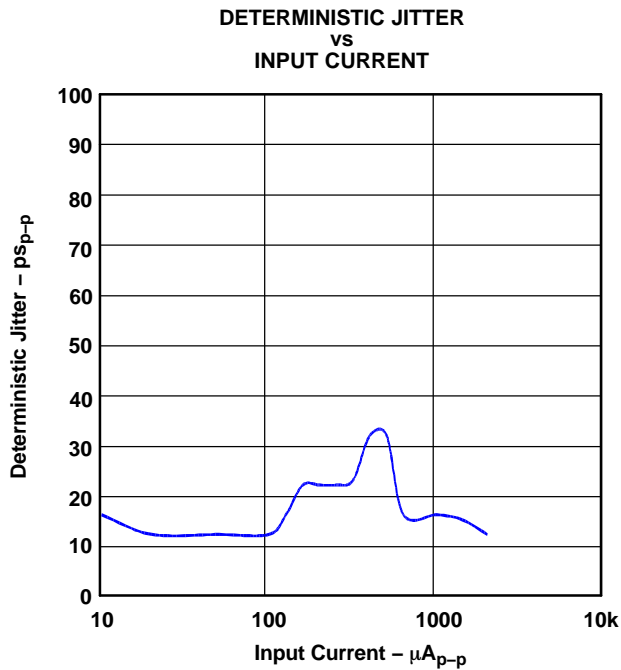
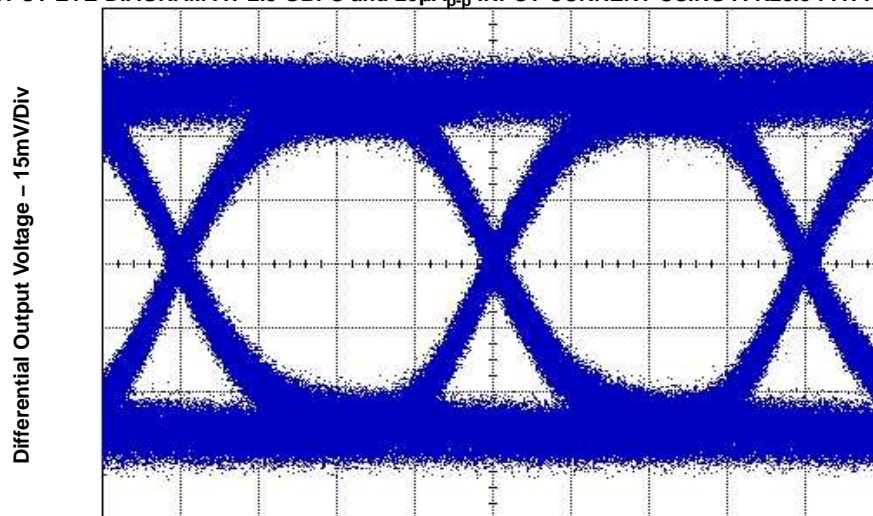

Figure 13.

**TYPICAL CHARACTERISTICS (continued)**

$V_{CC} = +3.3\text{ V}$  and  $T_A = +25^\circ\text{C}$  (unless otherwise noted)

**OUTPUT EYE-DIAGRAM AT 2.5 GBPS and  $20\mu\text{A}_{p-p}$  INPUT CURRENT USING A K28.5 PATTERN**



Time - 100ps/Div  
Figure 14.

**OUTPUT EYE-DIAGRAM AT 2.5 GBPS and  $2\text{ mA}_{p-p}$  INPUT CURRENT USING A K28.5 PATTERN**

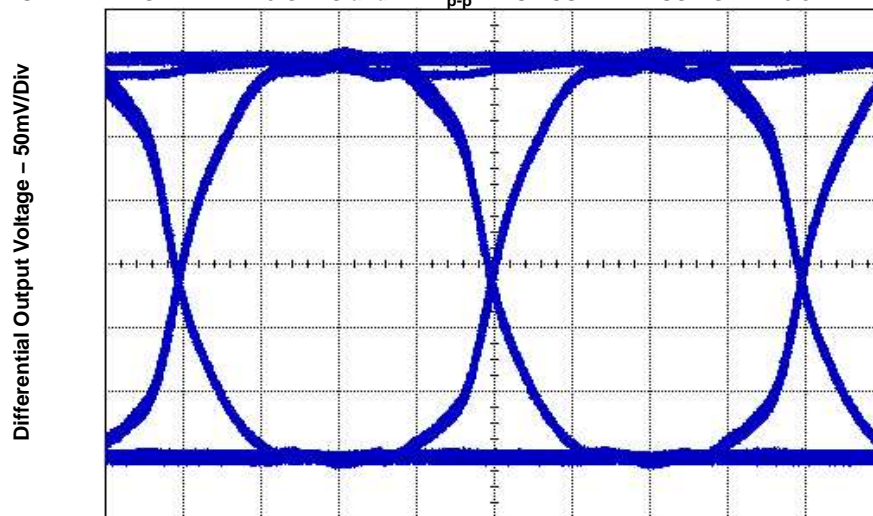

Time - 100ps/Div  
Figure 15.

**PACKAGING INFORMATION**

Orderable Device	Status <sup>(1)</sup>	Package Type	Package Drawing	Pins	Package Qty	Eco Plan <sup>(2)</sup>	Lead/Ball Finish	MSL Peak Temp <sup>(3)</sup>
ONET2511TAY	ACTIVE	DIESALE	Y	0	418	Green (RoHS & no Sb/Br)	Call TI	N / A for Pkg Type

<sup>(1)</sup> The marketing status values are defined as follows:

**ACTIVE:** Product device recommended for new designs.

**LIFEBUY:** TI has announced that the device will be discontinued, and a lifetime-buy period is in effect.

**NRND:** Not recommended for new designs. Device is in production to support existing customers, but TI does not recommend using this part in a new design.

**PREVIEW:** Device has been announced but is not in production. Samples may or may not be available.

**OBSOLETE:** TI has discontinued the production of the device.

<sup>(2)</sup> Eco Plan - The planned eco-friendly classification: Pb-Free (RoHS), Pb-Free (RoHS Exempt), or Green (RoHS & no Sb/Br) - please check <http://www.ti.com/productcontent> for the latest availability information and additional product content details.

**TBD:** The Pb-Free/Green conversion plan has not been defined.

**Pb-Free (RoHS):** TI's terms "Lead-Free" or "Pb-Free" mean semiconductor products that are compatible with the current RoHS requirements for all 6 substances, including the requirement that lead not exceed 0.1% by weight in homogeneous materials. Where designed to be soldered at high temperatures, TI Pb-Free products are suitable for use in specified lead-free processes.

**Pb-Free (RoHS Exempt):** This component has a RoHS exemption for either 1) lead-based flip-chip solder bumps used between the die and package, or 2) lead-based die adhesive used between the die and leadframe. The component is otherwise considered Pb-Free (RoHS compatible) as defined above.

**Green (RoHS & no Sb/Br):** TI defines "Green" to mean Pb-Free (RoHS compatible), and free of Bromine (Br) and Antimony (Sb) based flame retardants (Br or Sb do not exceed 0.1% by weight in homogeneous material)

<sup>(3)</sup> MSL, Peak Temp. -- The Moisture Sensitivity Level rating according to the JEDEC industry standard classifications, and peak solder temperature.

**Important Information and Disclaimer:**The information provided on this page represents TI's knowledge and belief as of the date that it is provided. TI bases its knowledge and belief on information provided by third parties, and makes no representation or warranty as to the accuracy of such information. Efforts are underway to better integrate information from third parties. TI has taken and continues to take reasonable steps to provide representative and accurate information but may not have conducted destructive testing or chemical analysis on incoming materials and chemicals. TI and TI suppliers consider certain information to be proprietary, and thus CAS numbers and other limited information may not be available for release.

In no event shall TI's liability arising out of such information exceed the total purchase price of the TI part(s) at issue in this document sold by TI to Customer on an annual basis.

## IMPORTANT NOTICE

Texas Instruments Incorporated and its subsidiaries (TI) reserve the right to make corrections, modifications, enhancements, improvements, and other changes to its products and services at any time and to discontinue any product or service without notice. Customers should obtain the latest relevant information before placing orders and should verify that such information is current and complete. All products are sold subject to TI's terms and conditions of sale supplied at the time of order acknowledgment.

TI warrants performance of its hardware products to the specifications applicable at the time of sale in accordance with TI's standard warranty. Testing and other quality control techniques are used to the extent TI deems necessary to support this warranty. Except where mandated by government requirements, testing of all parameters of each product is not necessarily performed.

TI assumes no liability for applications assistance or customer product design. Customers are responsible for their products and applications using TI components. To minimize the risks associated with customer products and applications, customers should provide adequate design and operating safeguards.

TI does not warrant or represent that any license, either express or implied, is granted under any TI patent right, copyright, mask work right, or other TI intellectual property right relating to any combination, machine, or process in which TI products or services are used. Information published by TI regarding third-party products or services does not constitute a license from TI to use such products or services or a warranty or endorsement thereof. Use of such information may require a license from a third party under the patents or other intellectual property of the third party, or a license from TI under the patents or other intellectual property of TI.

Reproduction of TI information in TI data books or data sheets is permissible only if reproduction is without alteration and is accompanied by all associated warranties, conditions, limitations, and notices. Reproduction of this information with alteration is an unfair and deceptive business practice. TI is not responsible or liable for such altered documentation. Information of third parties may be subject to additional restrictions.

Resale of TI products or services with statements different from or beyond the parameters stated by TI for that product or service voids all express and any implied warranties for the associated TI product or service and is an unfair and deceptive business practice. TI is not responsible or liable for any such statements.

TI products are not authorized for use in safety-critical applications (such as life support) where a failure of the TI product would reasonably be expected to cause severe personal injury or death, unless officers of the parties have executed an agreement specifically governing such use. Buyers represent that they have all necessary expertise in the safety and regulatory ramifications of their applications, and acknowledge and agree that they are solely responsible for all legal, regulatory and safety-related requirements concerning their products and any use of TI products in such safety-critical applications, notwithstanding any applications-related information or support that may be provided by TI. Further, Buyers must fully indemnify TI and its representatives against any damages arising out of the use of TI products in such safety-critical applications.

TI products are neither designed nor intended for use in military/aerospace applications or environments unless the TI products are specifically designated by TI as military-grade or "enhanced plastic." Only products designated by TI as military-grade meet military specifications. Buyers acknowledge and agree that any such use of TI products which TI has not designated as military-grade is solely at the Buyer's risk, and that they are solely responsible for compliance with all legal and regulatory requirements in connection with such use.

TI products are neither designed nor intended for use in automotive applications or environments unless the specific TI products are designated by TI as compliant with ISO/TS 16949 requirements. Buyers acknowledge and agree that, if they use any non-designated products in automotive applications, TI will not be responsible for any failure to meet such requirements.

Following are URLs where you can obtain information on other Texas Instruments products and application solutions:

<b>Products</b>		<b>Applications</b>	
Amplifiers	<a href="http://amplifier.ti.com">amplifier.ti.com</a>	Audio	<a href="http://www.ti.com/audio">www.ti.com/audio</a>
Data Converters	<a href="http://dataconverter.ti.com">dataconverter.ti.com</a>	Automotive	<a href="http://www.ti.com/automotive">www.ti.com/automotive</a>
DSP	<a href="http://dsp.ti.com">dsp.ti.com</a>	Broadband	<a href="http://www.ti.com/broadband">www.ti.com/broadband</a>
Interface	<a href="http://interface.ti.com">interface.ti.com</a>	Digital Control	<a href="http://www.ti.com/digitalcontrol">www.ti.com/digitalcontrol</a>
Logic	<a href="http://logic.ti.com">logic.ti.com</a>	Military	<a href="http://www.ti.com/military">www.ti.com/military</a>
Power Mgmt	<a href="http://power.ti.com">power.ti.com</a>	Optical Networking	<a href="http://www.ti.com/opticalnetwork">www.ti.com/opticalnetwork</a>
Microcontrollers	<a href="http://microcontroller.ti.com">microcontroller.ti.com</a>	Security	<a href="http://www.ti.com/security">www.ti.com/security</a>
RFID	<a href="http://www.ti-rfid.com">www.ti-rfid.com</a>	Telephony	<a href="http://www.ti.com/telephony">www.ti.com/telephony</a>
Low Power Wireless	<a href="http://www.ti.com/lpw">www.ti.com/lpw</a>	Video & Imaging	<a href="http://www.ti.com/video">www.ti.com/video</a>
		Wireless	<a href="http://www.ti.com/wireless">www.ti.com/wireless</a>

Mailing Address: Texas Instruments, Post Office Box 655303, Dallas, Texas 75265  
Copyright © 2007, Texas Instruments Incorporated