

Product Bulletin OP123
June 1996

GaAs Hermetic Infrared Emitting Diodes Types OP123, OP124

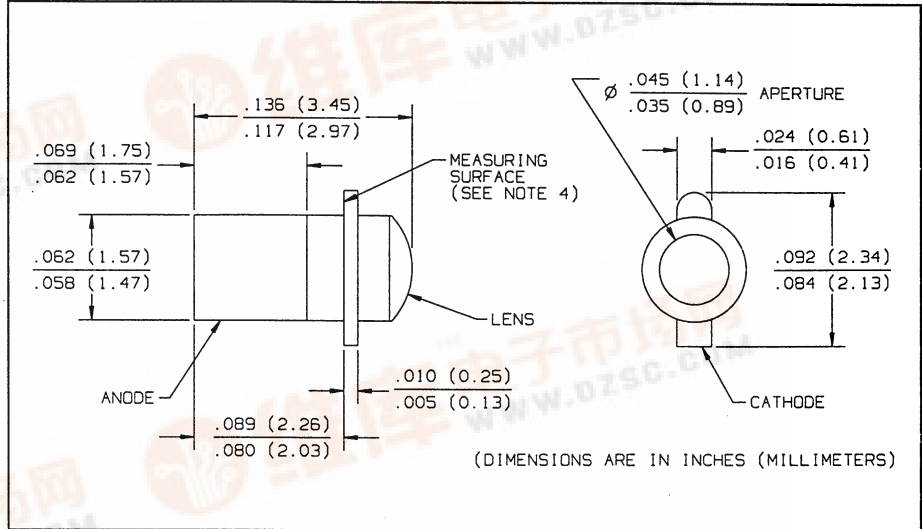
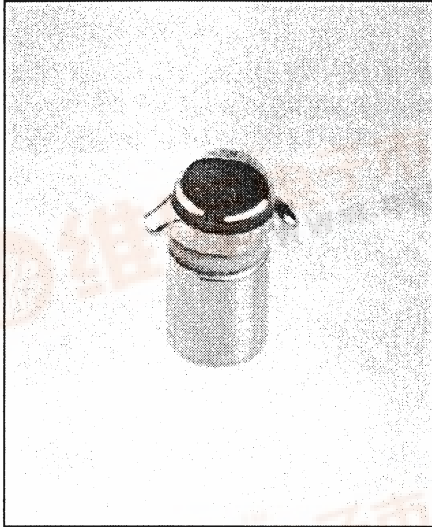

Features

- Miniature hermetically sealed "Pill" package
- Enhanced temperature range
- Ideal for direct mounting to PC boards⁽¹⁾
- High power output
- Mechanically and spectrally matched to the OP600 phototransistor and the OP300 photodarlington

Description

The OP123 and OP124 series are high intensity gallium arsenide infrared emitting diodes mounted in miniature "Pill" type hermetically sealed packages. This package style is intended for direct mounting into PC boards.

Absolute Maximum Ratings (T_A = 25° C unless otherwise noted)

Reverse Voltage	2.0 V
Continuous Forward Current	100 mA
Peak Forward Current (2 μs pulse width, 0.1% duty cycle)	1.0 A
Storage Temperature Range	-65° C to +150° C
Operating Temperature Range	-65° C to +125° C
Soldering Temperature (5 sec. with soldering iron)	260° C ⁽¹⁾⁽²⁾
Power Dissipation	150 mW ⁽³⁾

Notes:

- (1) Refer to Application Bulletin 202 which reviews proper soldering techniques for pill-type devices.
- (2) No clean or low solids, RMA flux is recommended. Duration can be extended to 10 sec. max. when flow soldering.
- (3) Derate linearly 1.50 mW/° C above 25° C.
- (4) E_e(APT) is measured using a 0.031" (0.787 mm) diameter apertured sensor placed 0.50" (12.7 mm) from the measuring surface.

Typical Performance Curves Percent Changes in Radiant Intensity vs Time

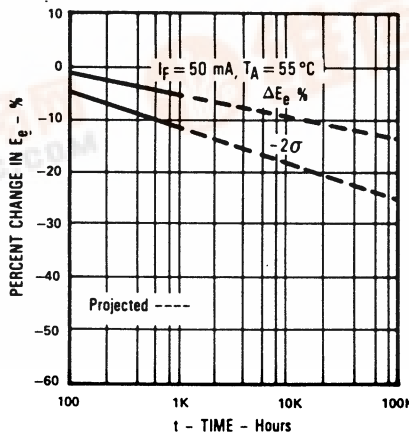

Coupling Characteristics of OP123 and OP600

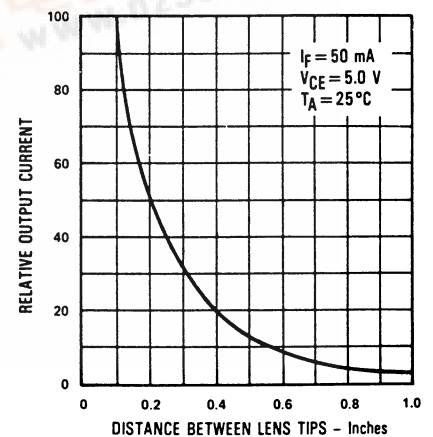

Types OP123, OP124

Electrical Characteristics ($T_A = 25^\circ\text{C}$ unless otherwise noted)

INFRARED
EMITTING
DIODES

SYMBOL	PARAMETER	MIN	TYP	MAX	UNITS	TEST CONDITIONS
$E_e(\text{APT})$	Apertured Radiant Incidence	OP123 OP124	0.40 1.00		mW/cm^2	$I_F = 50\text{ mA}^{(4)}$
V_F	Forward Voltage			1.50	V	$I_F = 50\text{ mA}$
I_R	Reverse Current			100	μA	$V_R = 2.0\text{ V}$
λ_p	Wavelength at Peak Emission		935		nm	$I_F = 50\text{ mA}$
B	Spectral Bandwidth Between Half Power Points		50		nm	$I_F = 50\text{ mA}$
$\Delta\lambda_p/\Delta T$	Spectral shift with Temperature		+0.30		$\text{nm}/^\circ\text{C}$	$I_F = \text{Constant}$
θ_{HP}	Emission Angle at Half Power Points		24		Deg.	$I_F = 50\text{ mA}$
t_r	Output Rise Time		1000		ns	$I_F(\text{PK}) = 100\text{ mA}$, $\text{PW} = 10.0\ \mu\text{s}$, $\text{D.C.} = 10.0\%$
t_f	Output Fall Time		500		ns	$I_F(\text{PK}) = 100\text{ mA}$, $\text{PW} = 10.0\ \mu\text{s}$, $\text{D.C.} = 10.0\%$

Typical Performance Curves

Forward Voltage vs Forward Current

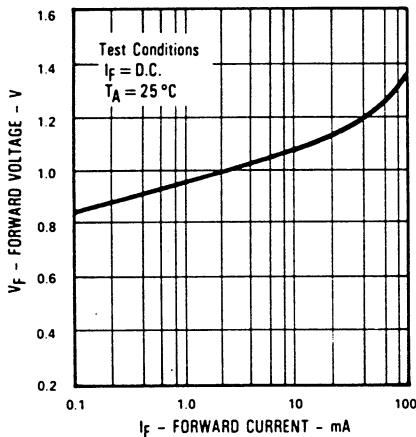

Forward Voltage and Radiant Incidence vs Forward Current

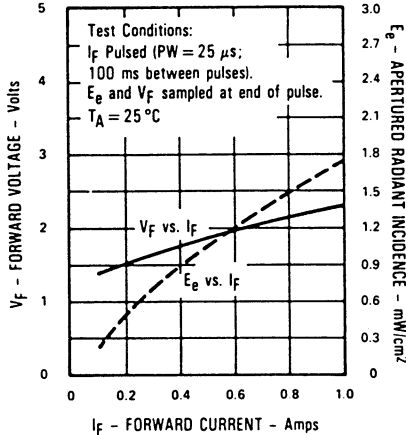

Forward Voltage vs Ambient Temperature

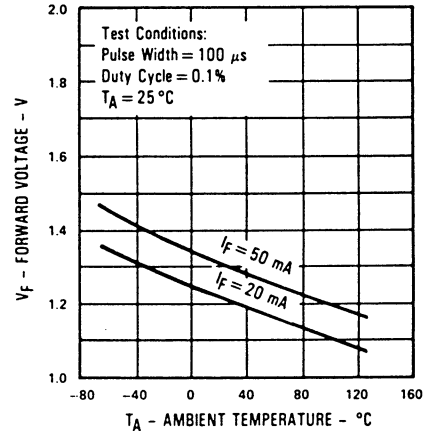

Rise Time and Fall Time vs Forward Current

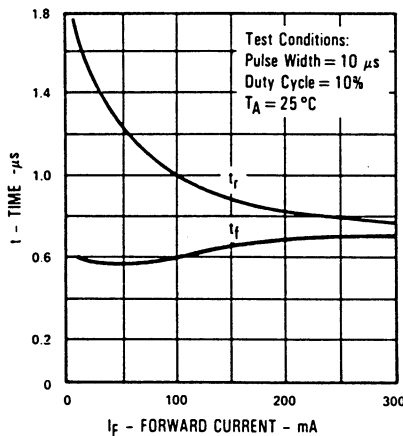

Normalized Power Output vs Ambient Temperature

