

19-3731; Rev 0; 10/92

# MAXIM

## Low-Noise Precision Operational Amplifiers

OP27/OP37

### General Description

The OP27/OP37 precision operational amplifiers provide lower noise and higher speed with the same input offset and drift specifications as the OP07. Both parts have a 10 $\mu$ V offset, 0.2 $\mu$ V/ $^{\circ}$ C drift, and 1.8 million gain. Coupled with a low-voltage noise of 3.5nV/ $\sqrt{\text{Hz}}$  at 10Hz and a low 1/f noise corner frequency of 2.7Hz, the OP27/OP37 are optimized for accurate amplification of low-level signals. The OP27 features an 8MHz gain-bandwidth product and a 2.8V/ $\mu$ s slew rate. For applications demanding higher speed, the OP37 has a 63MHz gain-bandwidth product, 17V/ $\mu$ s slew rate, and is stable at gains of five or more.

An output swing of  $\pm 10$ V into 600 $\Omega$  together with low distortion make the OP27/OP37 ideal for professional audio applications.

For applications requiring greater precision or lower noise than the OP27 or OP37, see the MAX427/MAX437 and the MAX410/MAX412/MAX414 data sheets.

### Applications

- Low-Noise DC Amplifiers
- Microphone Amplifiers
- Precision Amplifiers
- Tape-Head Preamplifiers
- Thermocouple Amplifiers
- Low-Level Signal Processing
- Medical Instrumentation
- Strain-Gauge Amplifiers
- High-Accuracy Data Acquisition

### Typical Application Circuit

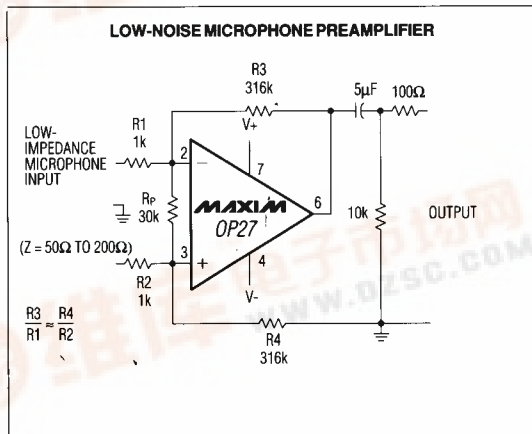

### Features

- ◆ 10 $\mu$ V Input Offset Voltage
- ◆ 0.2 $\mu$ V/ $^{\circ}$ C Drift
- ◆ 3nV/ $\sqrt{\text{Hz}}$  Input Noise Voltage (1kHz)
- ◆ 80nV<sub>p-p</sub> Noise (0.1Hz to 10Hz)
- ◆ 2.8V/ $\mu$ s Slew Rate (OP27)
- ◆ 17V/ $\mu$ s Slew Rate (OP37)
- ◆ 8MHz Gain-Bandwidth Product (OP27)
- ◆ 63MHz Gain-Bandwidth Product (OP37)

### Ordering Information

| PART   | TEMP. RANGE                          | PIN-PACKAGE   |
|--------|--------------------------------------|---------------|
| OP27EP | 0 $^{\circ}$ C to +70 $^{\circ}$ C   | 8 Plastic DIP |
| OP27FP | 0 $^{\circ}$ C to +70 $^{\circ}$ C   | 8 Plastic DIP |
| OP27GP | -40 $^{\circ}$ C to +85 $^{\circ}$ C | 8 Plastic DIP |
| OP27GS | -40 $^{\circ}$ C to +85 $^{\circ}$ C | 8 SO          |
| OP27EZ | -40 $^{\circ}$ C to +85 $^{\circ}$ C | 8 CERDIP      |
| OP27FZ | -40 $^{\circ}$ C to +85 $^{\circ}$ C | 8 CERDIP      |
| OP27GZ | -40 $^{\circ}$ C to +85 $^{\circ}$ C | 8 CERDIP      |
| OP27EJ | -40 $^{\circ}$ C to +85 $^{\circ}$ C | 8 TO-99       |
| OP27FJ | -40 $^{\circ}$ C to +85 $^{\circ}$ C | 8 TO-99       |

Ordering Information continued on last page.

### Pin Configurations

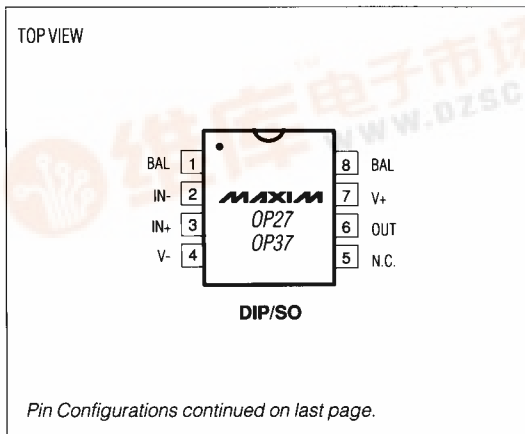

Pin Configurations continued on last page.

MAXIM

Maxim Integrated Products 1

Call toll free 1-800-998-8800 for free samples or literature.



# Low-Noise Precision Operational Amplifiers

## ABSOLUTE MAXIMUM RATINGS

|   |            |
|---|------------|
| Supply Voltage  | ±22V       |
| Input Voltage (Note 1)                                | ±22V       |
| Output Short-Circuit Duration                         | Continuous |
| Differential Input Voltage (Note 2)                   | ±0.7V      |
| Differential Input Current (Note 2)                   | ±25mA      |
| Continuous Power Dissipation (T <sub>A</sub> = +70°C) |            |
| Plastic DIP (derate 9.09mW/°C above +70°C)            | 727mW      |
| SO (derate 5.88mW/°C above +70°C)                     | 471mW      |
| CERDIP (derate 8.00mW/°C above +70°C)                 | 640mW      |
| TO-99 (derate 6.67mW/°C above +70°C)                  | 533mW      |

### Operating Temperature Ranges:

|                                      |                 |
|--------------------------------------|-----------------|
| OP27/OP37EP/FP                       | 0°C to +70°C    |
| OP27/OP37G_EZ/EJ/FZ/FJ               | -40°C to +85°C  |
| OP27/OP37A_B_JC_                     | -55°C to +125°C |
| Junction Temperature Range           | -65°C to +150°C |
| Storage Temperature Range            | -65°C to +150°C |
| Lead Temperature (soldering, 10 sec) | +300°C          |

**Note 1:** For supply voltages less than ±22V, the absolute maximum input voltage is equal to the supply voltage.

**Note 2:** OP27/OP37 inputs are protected by back-to-back diodes. Current-limiting resistors are not used in order to achieve low noise. If differential input voltage exceeds ±0.7V, the input current should be limited to 25mA.

*Stresses beyond those listed under "Absolute Maximum Ratings" may cause permanent damage to the device. These are stress ratings only, and functional operation of the device at these or any other conditions beyond those indicated in the operational sections of the specifications is not implied. Exposure to absolute maximum rating conditions for extended periods may affect device reliability.*

## ELECTRICAL CHARACTERISTICS

(V<sub>S</sub> = ±15V, T<sub>A</sub> = +25°C, unless otherwise noted.)

| PARAMETER  | SYMBOL                | CONDITIONS   | OP27A/E<br>OP37A/E |       |     | OP27B/F<br>OP37B/F |       |     | OP27C/G<br>OP37C/G |       |                   | UNITS |
|--|-----------------------|--|--------------------|-------|-----|--------------------|-------|-----|--------------------|-------|-------------------|-------|
|  |                       |  | MIN                | TYP   | MAX | MIN                | TYP   | MAX | MIN                | TYP   | MAX               |       |
| Input Offset Voltage (Note 3)                    | V <sub>OS</sub>       |  | 10                 | 25    |     | 20                 | 60    |     | 30                 | 100   | μV                |       |
| Long-Term V <sub>OS</sub> Stability (Notes 4, 5) | V <sub>OS</sub> /TIME |  | 0.2                | 1.0   |     | 0.3                | 1.5   |     | 0.4                | 2.0   | μV/Mo             |       |
| Input Bias Current                               | I <sub>B</sub>        |  | ±10                | ±40   |     | ±12                | ±55   |     | ±15                | ±80   | nA                |       |
| Input Offset Current                             | I <sub>OS</sub>       |  | 7                  | 35    |     | 9                  | 50    |     | 12                 | 75    | nA                |       |
| Input Voltage Range                              | I <sub>VR</sub>       |  | ±11.0              | ±12.3 |     | ±11.0              | ±12.3 |     | ±11.0              | ±12.3 | V                 |       |
| Input Resistance - Differential Mode (Note 6)    | R <sub>IN</sub>       |  | 1.3                | 6     |     | 0.94               | 5     |     | 0.7                | 4     | MΩ                |       |
| Input Resistance - Common Mode                   | R <sub>INCM</sub>     |  | 3                  |       |     | 2.5                |       |     | 2                  |       | GΩ                |       |
| Input Noise Voltage (Notes 5, 7)                 | e <sub>np-p</sub>     | 0.1Hz to 10Hz  | 0.08               | 0.18  |     | 0.08               | 0.18  |     | 0.09               | 0.25  | μV <sub>P-P</sub> |       |
| Input Noise-Voltage Density (Note 5)             | e <sub>n</sub>        | f <sub>o</sub> = 10Hz  | 3.5                | 5.5   |     | 3.5                | 5.5   |     | 3.8                | 8.0   | nV/√Hz            |       |
|  |                       | f <sub>o</sub> = 30Hz  | 3.1                | 4.5   |     | 3.1                | 4.5   |     | 3.3                | 5.6   |                   |       |
|  |                       | f <sub>o</sub> = 1kHz  | 3.0                | 3.8   |     | 3.0                | 3.8   |     | 3.2                | 4.5   |                   |       |
| Input Noise-Current Density (Notes 5, 8)         | i <sub>n</sub>        | f <sub>o</sub> = 10Hz  | 1.7                | 4.0   |     | 1.7                | 4.0   |     | 1.7                |       | pA/√Hz            |       |
|  |                       | f <sub>o</sub> = 30Hz  | 1.0                | 2.3   |     | 1.0                | 2.3   |     | 1.0                |       |                   |       |
|  |                       | f <sub>o</sub> = 1kHz  | 0.4                | 0.6   |     | 0.4                | 0.6   |     | 0.4                | 0.6   |                   |       |
| Large-Signal Voltage Gain                        | A <sub>VO</sub>       | R <sub>L</sub> ≥ 2kΩ, V <sub>O</sub> = ±10V                                | 1000               | 1800  |     | 1000               | 1800  |     | 700                | 1500  | V/mV              |       |
|  |                       | R <sub>L</sub> ≥ 1kΩ, V <sub>O</sub> = ±10V                                | 800                | 1500  |     | 800                | 1500  |     | 400                | 1500  |                   |       |
|  |                       | R <sub>L</sub> ≥ 600Ω, V <sub>O</sub> = ±1V, V <sub>S</sub> = ±4V (Note 5) | 250                | 700   |     | 250                | 700   |     | 200                | 500   |                   |       |
| Output Voltage Swing                             | V <sub>O</sub>        | R <sub>L</sub> ≥ 2kΩ   | ±12.0              | ±13.8 |     | ±12.0              | ±13.8 |     | ±11.5              | ±13.5 | V                 |       |
|  |                       | R <sub>L</sub> ≥ 600Ω  | ±10.0              | ±11.5 |     | ±10.0              | ±11.5 |     | ±10.0              | ±11.5 |                   |       |

# Low-Noise Precision Operational Amplifiers

**OP27/OP37**

## ELECTRICAL CHARACTERISTICS (continued)

( $V_S = \pm 15V$ ,  $T_A = +25^\circ C$ , unless otherwise noted.)

| PARAMETER                       | SYMBOL | CONDITIONS                                    | OP27A/E<br>OP37A/E |     |     | OP27B/F<br>OP37B/F |     |     | OP27C/G<br>OP37C/G |     |     | UNITS     |
|---------------------------------|--------|---|--------------------|-----|-----|--------------------|-----|-----|--------------------|-----|-----|-----------|
|                                 |        |   | MIN                | TYP | MAX | MIN                | TYP | MAX | MIN                | TYP | MAX |           |
| Open-Loop Output Resistance     | $R_O$  | $V_O = 0, I_O = 0$                            | 70                 |     |     | 70                 |     |     | 70                 |     |     | $\Omega$  |
| Common-Mode Rejection Ratio     | CMRR   | $V_{CM} = \pm 11V$                            | 114                | 126 |     | 106                | 123 |     | 100                | 120 |     | dB        |
| Power-Supply Rejection Ratio    | PSRR   | $V_S = \pm 4V$ to $\pm 18V$                   |                    | 1   | 10  |                    | 1   | 10  |                    | 2   | 20  | $\mu V/V$ |
| Gain-Bandwidth Product (Note 5) | GBP    | $f_o = 100kHz$ , OP27                         | 5.0                | 8.0 |     | 5.0                | 8.0 |     | 5.0                | 8.0 |     | MHz       |
|                                 |        | $f_o = 10kHz$ , $Av_{CL} \geq 5$ , OP37       | 45                 | 63  |     | 45                 | 63  |     | 45                 | 63  |     |           |
|                                 |        | $f_o = 1MHz$ , $Av_{CL} \geq 5$ , OP37        | 40                 |     |     | 40                 |     |     | 40                 |     |     |           |
| Slew Rate (Note 5)              | SR     | $R_L \geq 2k\Omega$ , OP27                    | 1.7                | 2.8 |     | 1.7                | 2.8 |     | 1.7                | 2.8 |     | $V/\mu s$ |
|                                 |        | $R_L \geq 2k\Omega$ , $Av_{CL} \geq 5$ , OP37 | 11                 | 17  |     | 11                 | 17  |     | 11                 | 17  |     |           |
| Power Dissipation               | PD     | $V_O = 0$                                     | 90 140             |     |     | 90 140             |     |     | 100 170            |     |     | mW        |
| Offset Adjustment Range         |        | $R_P = 10k\Omega$                             | $\pm 4.0$          |     |     | $\pm 4.0$          |     |     | $\pm 4.0$          |     |     | mV        |

## ELECTRICAL CHARACTERISTICS

( $V_S = \pm 15V$ ,  $T_A = T_{MIN}$  to  $T_{MAX}$ , unless otherwise noted.)

| PARAMETER                             | SYMBOL   | CONDITIONS                            | OP27A<br>OP37A      |          |     | OP27B<br>OP37B      |          |     | OP27C<br>OP37C      |           |                  | UNITS |
|---------------------------------------|----------|---------------------------------------|---------------------|----------|-----|---------------------|----------|-----|---------------------|-----------|------------------|-------|
|                                       |          |                                       | MIN                 | TYP      | MAX | MIN                 | TYP      | MAX | MIN                 | TYP       | MAX              |       |
| Input Offset Voltage (Note 3)         | $V_{OS}$ |                                       | 30                  | 60       |     | 50                  | 200      |     | 70                  | 300       | $\mu V$          |       |
| Average-Offset Voltage Drift (Note 9) | TCVOS    |                                       | 0.2                 | 0.6      |     | 0.3                 | 1.3      |     | 0.4                 | 1.8       | $\mu V/^\circ C$ |       |
| Input Bias Current                    | $I_B$    |                                       | $\pm 20$            | $\pm 60$ |     | $\pm 28$            | $\pm 95$ |     | $\pm 35$            | $\pm 150$ | nA               |       |
| Input Offset Current                  | $I_{OS}$ |                                       | 10                  | 50       |     | 14                  | 85       |     | 20                  | 135       | nA               |       |
| Input Voltage Range                   | $I_{VR}$ |                                       | $\pm 10.3 \pm 11.5$ |          |     | $\pm 10.3 \pm 11.5$ |          |     | $\pm 10.2 \pm 11.5$ |           |                  | V     |
| Large-Signal Voltage Gain             | $AV_O$   | $R_L \geq 2k\Omega$ , $V_O = \pm 10V$ | 600                 | 1200     |     | 500                 | 1000     |     | 300                 | 800       | $V/mV$           |       |
| Maximum Output-Voltage Swing          | $V_O$    | $R_L \geq 2k\Omega$                   | $\pm 11.5 \pm 13.5$ |          |     | $\pm 11.0 \pm 13.2$ |          |     | $\pm 10.5 \pm 13.0$ |           |                  | V     |
| Common-Mode Rejection Ratio           | CMRR     | $V_{CM} = \pm 10V$                    | 108                 | 122      |     | 100                 | 119      |     | 94                  | 116       | dB               |       |
| Power-Supply Rejection Ratio          | PSRR     | $V_S = \pm 4.5V$ to $\pm 18V$         | 2                   | 16       |     | 2                   | 20       |     | 4                   | 51        | $\mu V/V$        |       |

## Low-Noise Precision Operational Amplifiers

### ELECTRICAL CHARACTERISTICS (continued)

( $V_S = \pm 15V$ ,  $T_A = T_{MIN}$  to  $T_{MAX}$ , unless otherwise noted.)

| PARAMETER                             | SYMBOL     | CONDITIONS                            | OP27E<br>OP37E |            |            | OP27F<br>OP37F |            |            | OP27G<br>OP37G |            |            | UNITS             |
|---------------------------------------|------------|---------------------------------------|----------------|------------|------------|----------------|------------|------------|----------------|------------|------------|-------------------|
|                                       |            |                                       | MIN            | TYP        | MAX        | MIN            | TYP        | MAX        | MIN            | TYP        | MAX        |                   |
| Input Offset Voltage (Note 3)         | $V_{OS}$   |                                       |                | 20         | 50         |                | 40         | 140        |                | 55         | 220        | $\mu V$           |
| Average Offset-Voltage Drift (Note 9) | $TCV_{OS}$ |                                       |                | 0.2        | 0.6        |                | 0.3        | 1.3        |                | 0.4        | 1.8        | $\mu V/^{\circ}C$ |
| Input Bias Current                    | $I_B$      |                                       |                | $\pm 14$   | $\pm 60$   |                | $\pm 18$   | $\pm 95$   |                | $\pm 25$   | $\pm 150$  | nA                |
| Input Offset Current                  | $I_{OS}$   |                                       |                | 10         | 50         |                | 14         | 85         |                | 20         | 135        | nA                |
| Input Voltage Range                   | $I_{VR}$   |                                       |                | $\pm 10.5$ | $\pm 11.8$ |                | $\pm 10.5$ | $\pm 11.8$ |                | $\pm 10.5$ | $\pm 11.8$ | V                 |
| Large-Signal Voltage Gain             | $A_{VO}$   | $R_L \geq 2k\Omega$ , $V_O = \pm 10V$ |                | 750        | 1500       |                | 700        | 1300       |                | 450        | 1000       | V/mV              |
| Output Voltage Swing                  | $V_O$      | $R_L \geq 2k\Omega$                   |                | $\pm 11.7$ | $\pm 13.6$ |                | $\pm 11.4$ | $\pm 13.5$ |                | $\pm 11.0$ | $\pm 13.3$ | V                 |
| Common-Mode Rejection Ratio           | CMRR       | $V_{CM} = \pm 10V$                    |                | 110        | 124        |                | 102        | 121        |                | 96         | 118        | dB                |
| Power-Supply Rejection Ratio          | PSRR       | $V_S = \pm 4.5V$ to $\pm 18V$         |                | 2          | 15         |                | 2          | 16         |                | 2          | 32         | $\mu V/V$         |

**Note 3:**  $V_{OS}$  is measured approximately 0.5 seconds after application of power.

**Note 4:** Long-term input offset voltage stability refers to the average trend line of  $V_{OS}$  vs. Time over extended periods after the first 30 days of operation.

**Note 5:** Guaranteed by design.

**Note 6:** Guaranteed by input bias current.

**Note 7:** See test circuit and frequency response curve for 0.1Hz to 10Hz tester (Figures 1, 6).

**Note 8:** See test circuit for current-noise measurement (Figure 2).

**Note 9:** The  $TCV_{OS}$  performance is within the specifications unnullled or when nulled with  $R_P = 8k\Omega$  to  $20k\Omega$ .  $TCV_{OS}$  is sample tested to 0.1% AQL for A/E grades. B/C/F/G are guaranteed by design.

### Typical Operating Characteristics

( $T_A = +25^{\circ}C$ , unless otherwise noted)

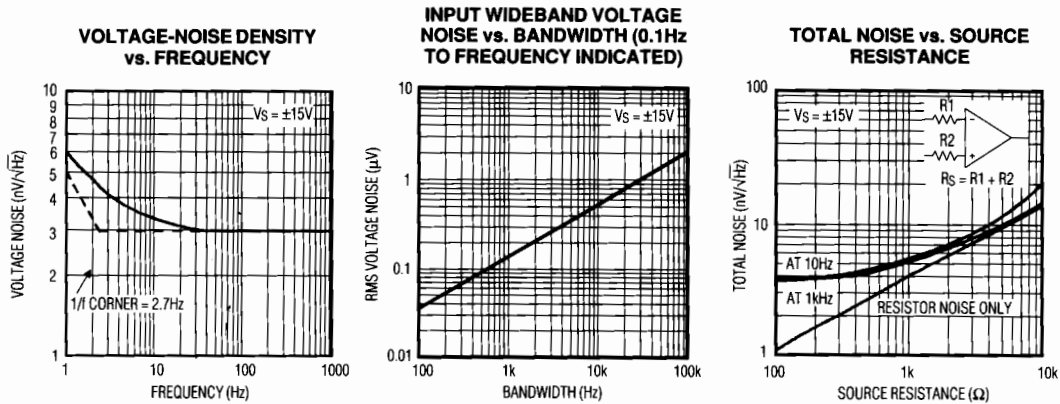

# Low-Noise Precision Operational Amplifiers

## Typical Operating Characteristics (continued)

OP27/OP37

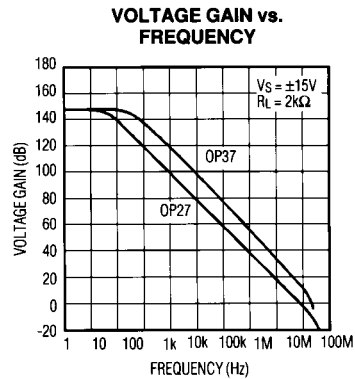
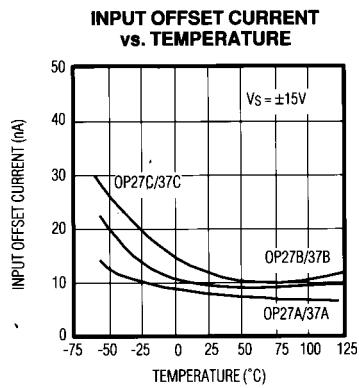
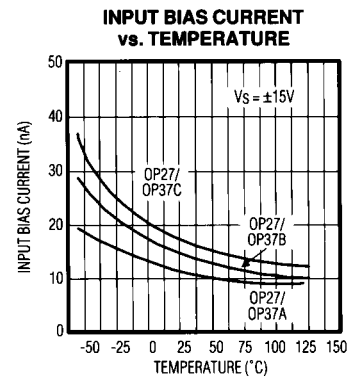
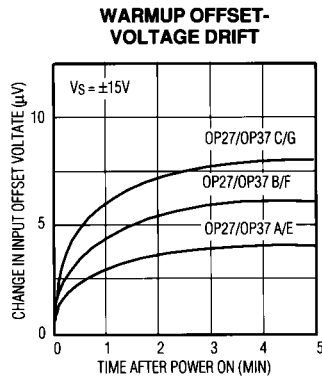
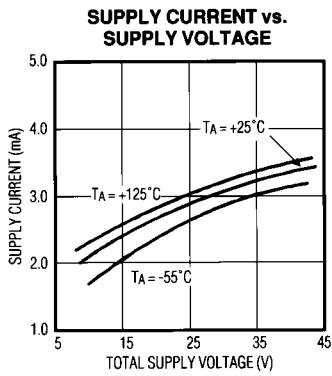
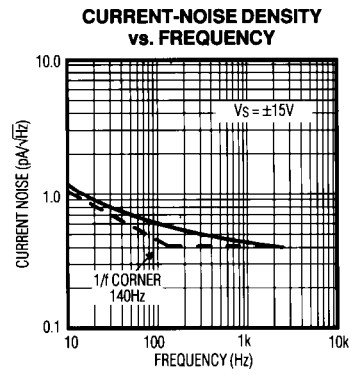
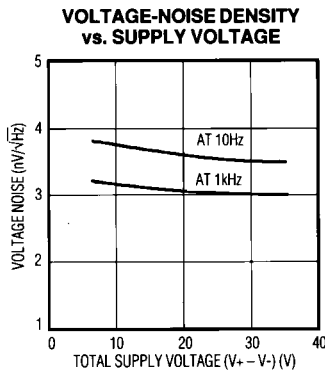
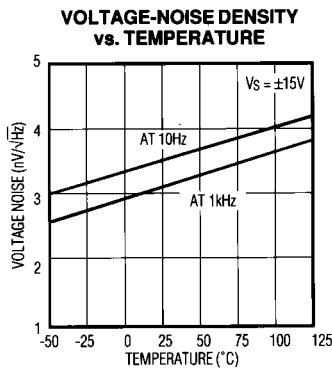

# Low-Noise Precision Operational Amplifiers

## Typical Operating Characteristics (continued)

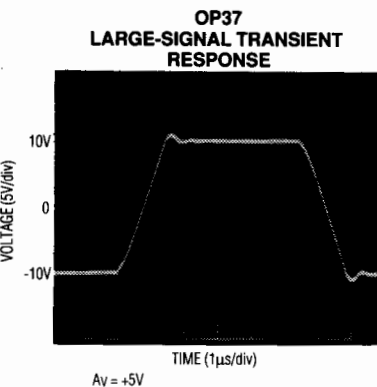
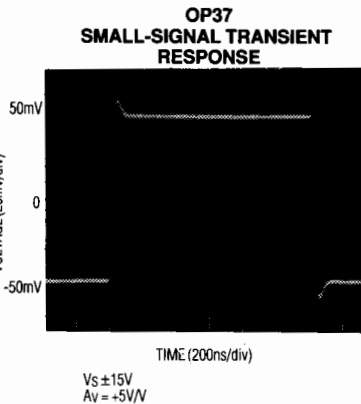
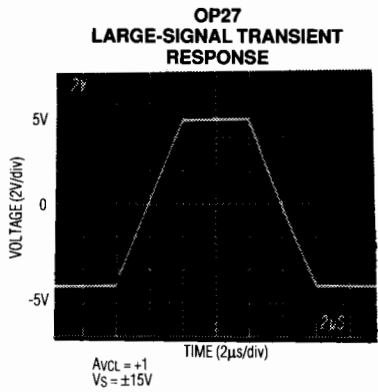
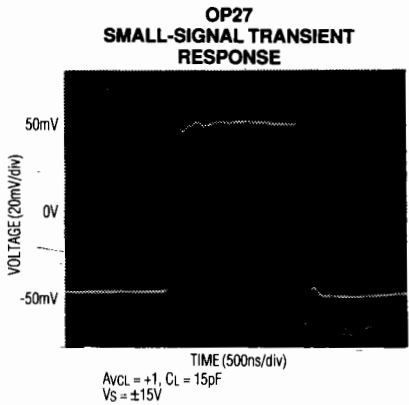
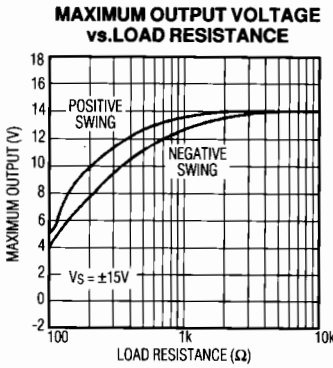
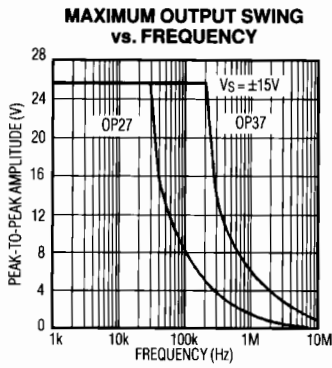
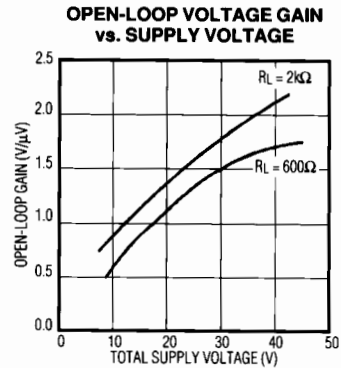
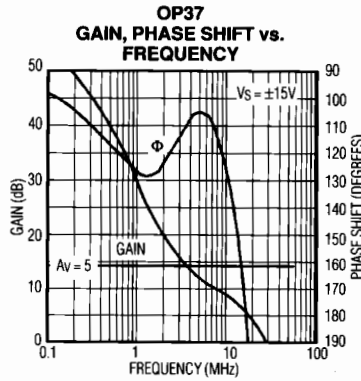
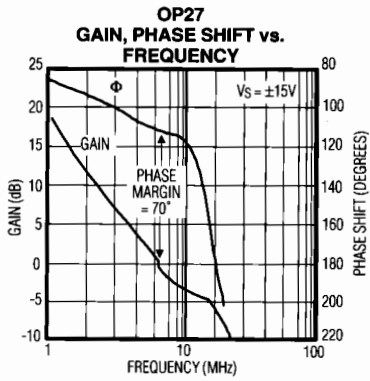

# Low-Noise Precision Operational Amplifiers

## Typical Operating Characteristics (continued)

OP27/OP37

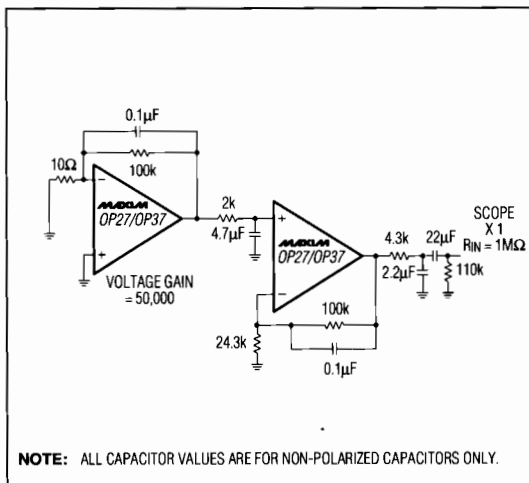
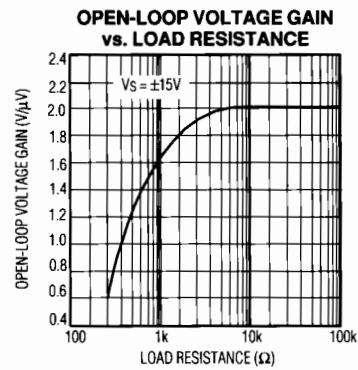
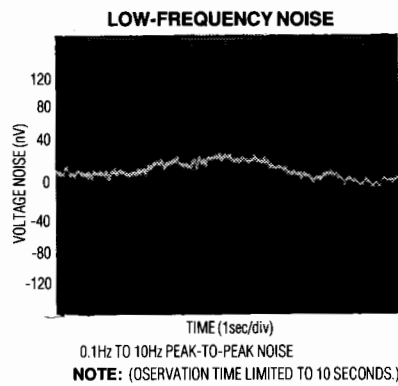

Figure 1. Voltage-Noise Test Circuit (0.1Hz to 10Hz)

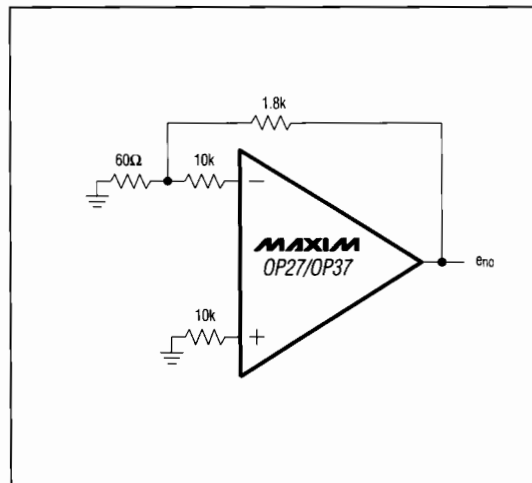

Figure 2. Current-Noise Test Circuit

### Applications Information

The OP27/OP37 provide stable operation with load capacitances of up to 2nF and  $\pm 10V$  output swings; larger capacitances should be decoupled with a  $50\Omega$  series resistor inside the feedback loop. The OP27 is unity-gain stable and the OP37 is stable at gains of five or greater.

Thermoelectric voltages generated by dissimilar metals at the input terminals degrade the drift performance. Connections to both inputs should be maintained at the same temperature for best operation.

## Low-Noise Precision Operational Amplifiers

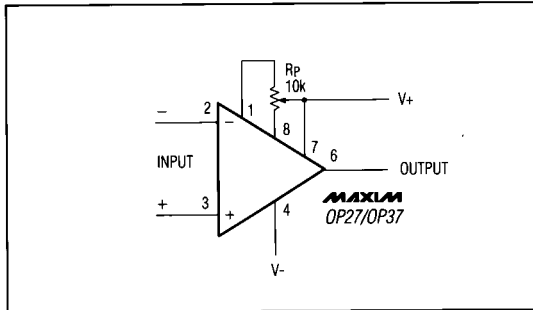

Figure 3. Offset Nulling Circuit

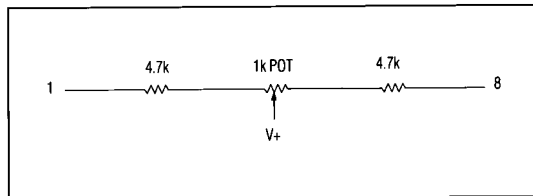

Figure 4. Alternate Offset-Voltage Adjustment

### Offset-Voltage Adjustment

Input offset voltage (VOS) is trimmed at the wafer level. If VOS adjustment is necessary, a 10kΩ trim potentiometer (pot) may be used and will not degrade TCVOs (Figure 3). Other trim pot values from 1kΩ to 1MΩ can be used with a slight degradation (0.1μV/°C to 0.2μV/°C) of TCVOs. Adjusting, but not zeroing, VOS creates a drift of approximately (VOS/300)μV/°C. For example, the change in TCVOs is 0.33μV/°C if VOS is adjusted to 100μV. The adjustment range with a 10kΩ trim pot is ±4mV. For a smaller range, reduce nulling sensitivity by connecting a smaller pot in series with fixed resistors; for example, Figure 4 has a ±280μV adjustment range.

### Noise Measurements

To measure the 80nV<sub>p-p</sub> noise specification of the OP27/OP37 in the 0.1Hz to 10Hz range, observe the following precautions:

1. The device must warm up for at least five minutes. Figure 5 shows how VOS typically increases 4μV with increases in chip temperature after power-up. In the 10sec measurement interval, temperature-induced effects can exceed 10nV.
2. For similar reasons, the device must be well-shielded from air currents, including those caused by motion. This minimizes thermocouple effects.

3. As shown in Figure 6, the 0.1Hz corner is defined by only one zero. A maximum test time of 10sec acts as an additional zero to eliminate noise contributions from the frequency band below 0.1Hz.

4. A noise-voltage-density test is recommended when measuring noise on a large number of units. A 10Hz noise-voltage-density measurement correlates well with a 0.1Hz to 10Hz peak-to-peak noise reading, since both results are determined by the white noise and the location of the 1/f corner frequency.

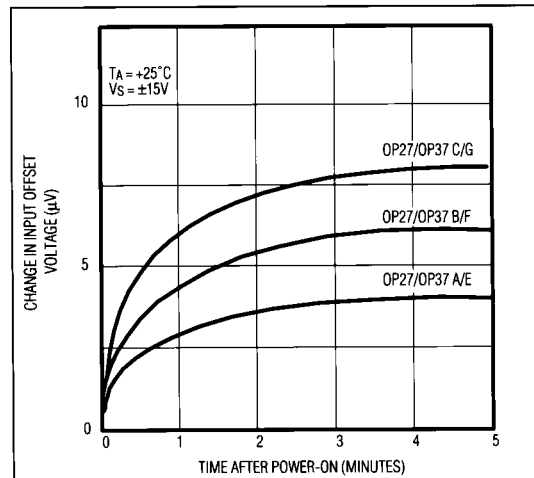

Figure 5. Warm-Up Offset Voltage Drift

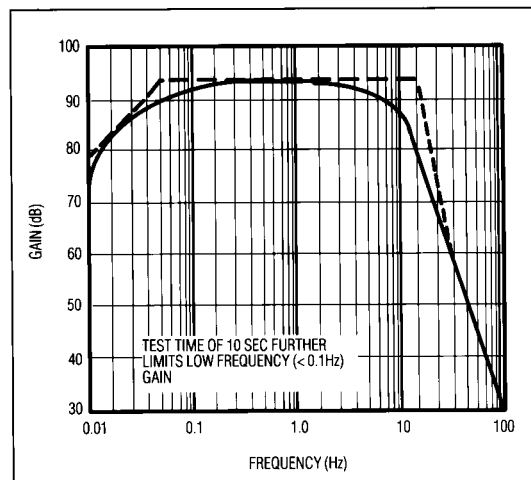

Figure 6. 0.1Hz to 10Hz V<sub>p-p</sub> Noise Tester Frequency Response



## Low-Noise Precision Operational Amplifiers

OP27/OP37

### Unity-Gain Buffer Applications (OP27 Only)

Figure 7 shows the circuit and output waveform with  $R_f \leq 100\Omega$ , and the input driven with a fast, large signal pulse ( $>1V$ ).

During the fast rise portion of the output, the input protection diodes short the output to the input, and a current, limited only by the output short-circuit protection, is drawn by the signal generator. With  $R_f \geq 500\Omega$ , the output is capable of handling the current required ( $I_L \leq 20mA$  at 10V) and a smooth transition occurs.

When  $R_f \geq 2k\Omega$ , a pole created with  $R_f$  and the amplifier's input capacitance (8pF) causes additional phase shift and reduces phase margin. A small capacitor (20pF to 50pF) in parallel with  $R_f$  eliminates this problem.

### Comments on Noise

The OP27/OP37 are very low-noise amplifiers. They have outstanding input voltage noise characteristics by operating the input stage at a high quiescent current. Input bias and offset currents, which would normally increase with the quiescent current, are minimized by bias-current cancellation circuitry. The OP27/OP37A and E grade devices have  $I_B$  and  $I_{OS}$  of only  $\pm 40nA$  and  $35nA$  respectively at  $+25^\circ C$ . This is particularly important with high source-resistances.

Voltage noise is inversely proportional to the square-root of bias current, but current noise is proportional to the square-root of bias current. The OP27/OP37 low-noise advantages are reduced when high source resistors are used.

$$\text{Total noise} = [(\text{voltage noise})^2 + (\text{current noise} \times R_S)^2 + (\text{resistor noise})^2]^{1/2}$$

Figure 8 shows noise vs. source resistance at 1kHz. To use this plot for wideband noise, multiply the vertical scale by the square-root of the bandwidth. The OP27/OP37 maintains low input noise voltage with  $R_S < 1k\Omega$ . With  $R_S > 1k\Omega$ , total noise increases and is dominated by the resistor noise, not the current or the voltage noise. It is only with  $R_S \geq 20k\Omega$  that current noise dominates. Current noise is not important for applications with  $R_S < 20k\Omega$ . The OP27/OP37 has lower total noise than the MAX400/OP07 for  $R_S < 10k\Omega$ . As  $R_S$  increases, the crossover between the OP27/OP37 and the MAX400/OP07 noise occurs in the  $R_S = 15k\Omega$  to  $40k\Omega$  region.

Figure 9 shows 0.1Hz to 10Hz peak-to-peak noise. Here, resistor noise is negligible and current noise ( $i_n$ ) becomes important, because  $i_n \propto 1/\sqrt{f}$ . The crossover with the MAX400/OP07 occurs in the  $R_S = 3k\Omega$  to  $5k\Omega$  range,

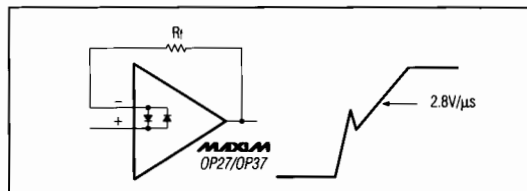

Figure 7. Pulsed Operation of Unity-Gain Buffer

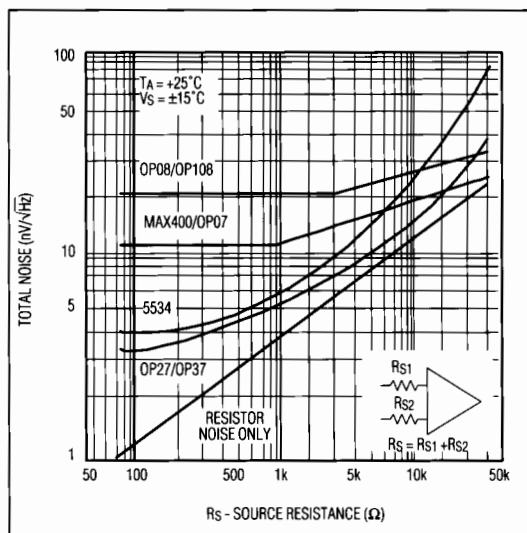

Figure 8. Noise vs. Source Resistance (Including Resistor Noise) at 1kHz

depending on whether balanced or unbalanced source resistors are used (at  $3k\Omega$  the  $I_B$  and  $I_{OS}$  error can be three times the  $V_{OS}$  specification). For low-frequency applications, the MAX400/OP07 is better than the OP27/OP37 when  $R_S > 3k\Omega$ , except when gain error is important. Figure 10 illustrates the 10Hz noise. As expected, the results fall between those of the previous two figures.

For reference, typical source resistances of some signal sources are listed in Table 1.

## Low-Noise Precision Operational Amplifiers

**Table 1. Signal Source vs. Source Impedance**

| DEVICE                                   | SOURCE IMPEDANCE | COMMENTS   |
|--|------------------|--|
| Strain Gauge                             | <500Ω            | Typically used in low-frequency applications.  |
| Magnetic Tapehead                        | < 1500Ω          | Low $I_B$ is very important to reduce self-magnetization problems when direct coupling is used. OP27 $I_B$ can be neglected. |
| Linear Variable Differential Transformer | < 1500Ω          | Used in rugged servo-feedback applications. Bandwidth of interest is 400Hz to 5kHz.  |

**Table 2. Open-Loop Gain vs. Frequency**

| FREQUENCY AT: | OPEN-LOOP GAIN |       |       |
|---------------|----------------|-------|-------|
|               | OP07           | OP27  | OP37  |
| 3Hz           | 100dB          | 124dB | 125dB |
| 10Hz          | 100dB          | 120dB | 125dB |
| 30Hz          | 90dB           | 110dB | 124dB |

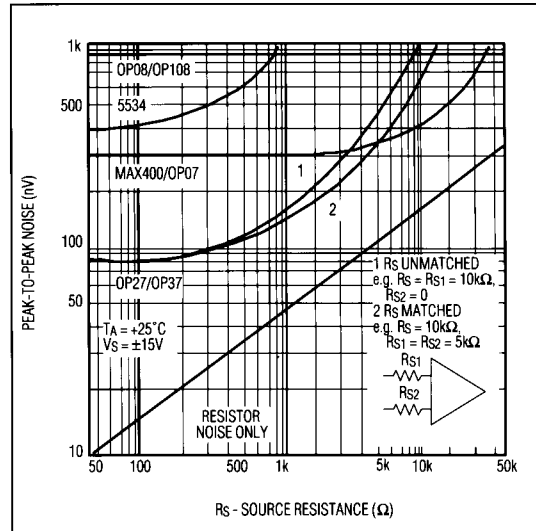

Figure 9. Peak-to-Peak Noise (0.1 to 10Hz) vs. Source Resistance (Includes Resistor Noise)

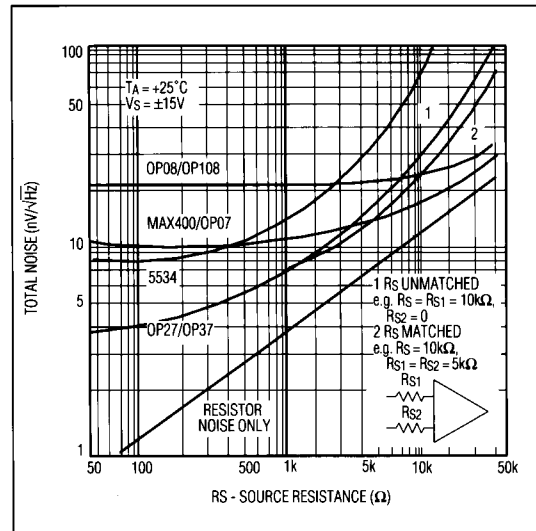

Figure 10. 10Hz Noise vs. Source Resistance (Includes Resistor Noise)

# Low-Noise Precision Operational Amplifiers

**OP27/OP37**

## Ordering Information (continued)

| PART          | TEMP. RANGE     | PIN-PACKAGE   |
|---------------|-----------------|---------------|
| OP27GJ        | -40°C to +85°C  | 8 TO-99       |
| OP27AZ        | -55°C to +125°C | 8 CERDIP*     |
| OP27BZ        | -55°C to +125°C | 8 CERDIP*     |
| OP27CZ        | -55°C to +125°C | 8 CERDIP*     |
| OP27AJ        | -55°C to +125°C | 8 TO-99*      |
| OP27BJ        | -55°C to +125°C | 8 TO-99*      |
| OP27CJ        | -55°C to +125°C | 8 TO-99*      |
| <b>OP37EP</b> | 0°C to +70°C    | 8 Plastic DIP |
| OP37FP        | 0°C to +70°C    | 8 Plastic DIP |
| OP37GP        | -40°C to +85°C  | 8 Plastic DIP |
| OP37GS        | -40°C to +85°C  | 8 SO          |
| OP37EZ        | -40°C to +85°C  | 8 CERDIP      |
| OP37FZ        | -40°C to +85°C  | 8 CERDIP      |
| OP37GZ        | -40°C to +85°C  | 8 CERDIP      |
| OP37EJ        | -40°C to +85°C  | 8 TO-99       |
| OP37FJ        | -40°C to +85°C  | 8 TO-99       |
| OP37GJ        | -40°C to +85°C  | 8 TO-99       |
| OP37AZ        | -55°C to +125°C | 8 CERDIP*     |
| OP37BZ        | -55°C to +125°C | 8 CERDIP*     |
| OP37CZ        | -55°C to +125°C | 8 CERDIP*     |
| OP37AJ        | -55°C to +125°C | 8 TO-99*      |
| OP37BJ        | -55°C to +125°C | 8 TO-99*      |
| OP37CJ        | -55°C to +125°C | 8 TO-99*      |

\*Contact factory for availability and processing to MIL-STD-883.

## Chip Topography

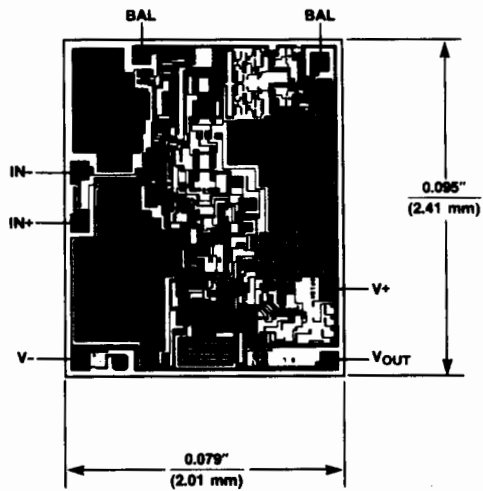

OP27/OP37

SUBSTRATE CONNECTED TO V-

## Pin Configurations (continued)

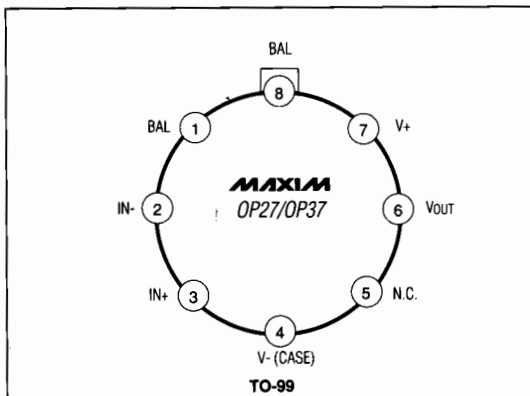

# Low-Noise Precision Operational Amplifiers

## Package Information

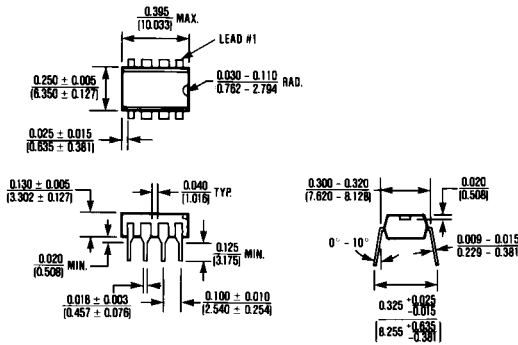

**8 Lead Plastic DIP**  
 $\theta_{JA} = 120^{\circ}\text{C/W}$   
 $\theta_{JC} = 70^{\circ}\text{C/W}$

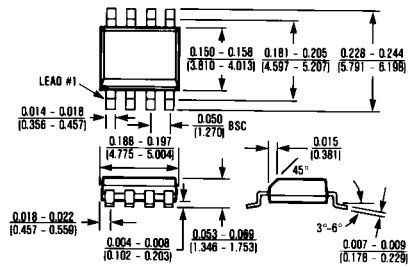

**8 Lead Small Outline**  
 $\theta_{JA} = 170^{\circ}\text{C/W}$   
 $\theta_{JC} = 80^{\circ}\text{C/W}$

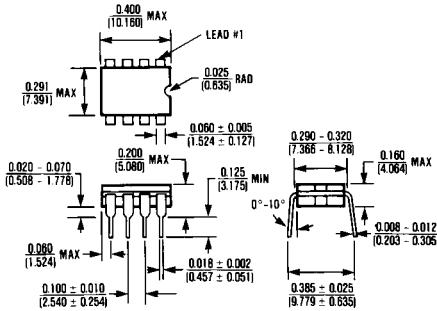

**8 Lead Cerdip**  
 $\theta_{JA} = 125^{\circ}\text{C/W}$   
 $\theta_{JC} = 55^{\circ}\text{C/W}$

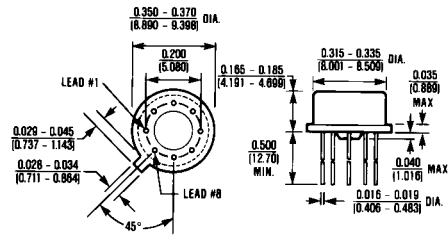

**8 Lead TO-99**  
 $\theta_{JA} = 150^{\circ}\text{C/W}$   
 $\theta_{JC} = 45^{\circ}\text{C/W}$

Maxim cannot assume responsibility for use of any circuitry other than circuitry entirely embodied in a Maxim product. No circuit patent licenses are implied. Maxim reserves the right to change the circuitry and specifications without notice at any time.

12 Maxim Integrated Products, 120 San Gabriel Drive, Sunnyvale, CA 94086 (408) 737-7600