



OV7910/OV7410/OV7411

OV7910P SINGLE-CHIP CMOS COLOR PAL CAMERA OV7410P/OV7411P SINGLE-CHIP CMOS B&W PAL CAMERA

Features

- **Single-chip 1/3 inch format video camera**
 - High-sensitivity version (OV7411P)
- **Composite video: PAL or S-Video**
- **Component video: RGB or YUV**
- **Sensitivity boost (+18 dB) /AGC on-off**
- **Automatic exposure/gain/white balance**
- **External frame sync capability**
- **Aperture correction**
- **I²C programmable:**
 - color sat., brightness, contrast, white balance, exposure time, gain
- **Gamma correction (0.45)-On/Off**
- **Low power consumption**
- **+5 volt-only power suPly**

General Description

The OV7910P (color) and OV7410P/OV7411P (black and white) Single-chip CMOS camera devices are designed to provide a high level of functionality in a single small-footprint package. Both devices support composite video and S-Video. The OV7910P imager also provides RGB and YCrCb video signals, and each device directly interfaces with a VCR TV monitor or other 75 ohm terminated input. A minimum of external components are required to complete a fully functional camera subsystem. The OV7910P/OV7410P/OV7411P video cameras require only a single 5-volt DC supply and have been designed for very low power operation. These products are ideal for all applications requiring a small footprint, low voltage, low power and low cost color or black and white video camera.

- **Video Conferencing**
- **Video Phones**
- **Video e-mail**
- **PC Multimedia**
- **Toys**
- **Security**
- **Surveillance**

AVDD	7	6	5	4	3	2	1	48	47	46	45	44	43	42	DEGND
RGSW	8							48	47	46	45	44	43	41	DEVDD
CEXP	9													40	HSHP
HSAT	10*													39	AMOD1
Rsvd11	11*													38	AMOD0
SMTawb	12*													37	PWDN
EVDD	13*													36	FSI
EGND	14*													35	PALSW
BUCO	15													34	FODD/I2CEN
GYYO	16													33	FSO/VSFR
RVCVO	17													32	VSHYNC/MIR
OVDD	18													31	VADPXO
		19	20	21	22	23	24	25	26	27	28	29	30		
		G2X	HIGAIN	BKLT	XCLK1	XCLK2	PAL	DVDD	DGND	GAMMA	AGCEN	AWBEN	AWBTM		
		AGND	Rsvd5	BPAVE	VcBRT	SVDD	SGND	VREF4	VREF3	VREF2	VREF1	SDA	SCL		

* NOTE: These pins are "no connect" in OV7410P/OV7411P sensor.

OV7910P/OV7410P/OV7411P PIN ASSIGNMENT

Array Size	PAL: 628 x 582 pixels
Image Area	PAL: 5.78 x 4.19 mm
Auto Electronic Exposure	1/60 - 1/15000 sec.
Min. Illumination (3000K)	OV7910P: < 3 lux @ f1.2 OV7410P: < 0.5 lux @ f1.2 OV7411P: < 0.2 lux @ f1.2
S/N Ratio	> 48 dB
Fixed Pattern Noise (FPN)	< 0.03% V _{P-P}
Dark Current	< 0.2 nA/cm ²
Dynamic Range	> 72 dB
Power Supply	5VDC, ±5%
Power Requirements	200 mW
Package Type	48-pin LCC



Table 1. Pin Description*(Pins designated with "*" are "no connect" in OV7410P/OV7411P sensor.)*

Pin No.	Name	Pin Type	Function/Description																				
01	SGND	V _{in}	Analog ground																				
02	SVDD	V _{in}	Analog power (+5VDC)																				
03	VcBRT	1.2V	Image brightness adjustment. Default set by internal resistor (~50K). Default may be changed by applying external bias to this pin.																				
04	BPAVE	Function (Default = 0)	Internal 3-point average selection "0" - Use internal 3-point averaging "1" - Bypass internal 3-point averaging																				
05	Rsvd5	V _{ref}	Internal reference																				
06	AGND	V _{in}	Analog ground																				
07	AVDD	V _{in}	Analog power (+5VDC)																				
08	RGSW	Function (Default = 0)	"Raw" data pixel selection "0" - select non- "raw" pixel data "1" - select "raw" pixel data																				
09	CEXP	Function (Default = 0)	Central exposure selection "0" - select normal mode "1" - select central exposure mode																				
10*	HSAT	Function (Default = 0) <i>(N/C on OV7410P/ OV7411P)</i>	Color Saturation selection "0" - select normal color saturation "1" - select increase color saturation by 25% Note: This function is not available on OV7410P/OV7411P Image Sensor. This pin is "no connect".																				
11*	Rsvd11	N/C	Pin reserved																				
12*	SMTawb	Function (Default = 0) <i>(N/C on OV7410P/ OV7411P)</i>	Automatic White Balance (AWB) Smart mode selection "0" - Disable smart mode "1" - Enable smart mode. Count pixels which contain a luminance signal between 10-80% of max. value. Note: This function is not available on OV7410P/OV7411P Image Sensor. This pin is "no connect".																				
13*	EVDD	V _{in} <i>(N/C on OV7410P/ OV7411P)</i>	Analog power (+5VDC) Note: This function is not available on OV7410P/OV7411P Image Sensor. This pin is "no connect".																				
14*	EGND	V _{in} <i>(N/C on OV7410P/ OV7411P)</i>	Analog ground Note: This function is not available on OV7410P/OV7411P Image Sensor. This pin is "no connect".																				
15	BUCO	Output	Video Output: Output format determined by pins 38 and 39 (AMOD1, AMOD0) <table border="1"> <thead> <tr> <th>AMOD1</th> <th>AMOD0</th> <th>Output Component</th> <th>Format</th> </tr> </thead> <tbody> <tr> <td>0</td> <td>0</td> <td>S-Video CO channel</td> <td>Composite</td> </tr> <tr> <td>0</td> <td>1</td> <td>Blue component</td> <td>RGB</td> </tr> <tr> <td>1</td> <td>0</td> <td>Cb component</td> <td>YUV or B/W</td> </tr> <tr> <td>1</td> <td>1</td> <td>Blue component</td> <td>RGB</td> </tr> </tbody> </table> Note: Modes (AMOD1, AMOD0) = 00, 01, 11 are not available for OV7410P Image Sensor	AMOD1	AMOD0	Output Component	Format	0	0	S-Video CO channel	Composite	0	1	Blue component	RGB	1	0	Cb component	YUV or B/W	1	1	Blue component	RGB
AMOD1	AMOD0	Output Component	Format																				
0	0	S-Video CO channel	Composite																				
0	1	Blue component	RGB																				
1	0	Cb component	YUV or B/W																				
1	1	Blue component	RGB																				

Table 1. Pin Description*(Pins designated with "*" are "no connect" in OV7410P/OV7411P sensor.)*

Pin No.	Name	Pin Type	Function/Description																				
16	GYYO	Output	Video Output: Output format determined by pins 38 and 39 (AMOD1, AMOD0) <table border="1"> <thead> <tr> <th>AMOD1</th> <th>AMOD0</th> <th>Output Component</th> <th>Format</th> </tr> </thead> <tbody> <tr> <td>0</td> <td>0</td> <td>S-Video YO channel</td> <td>Composite</td> </tr> <tr> <td>0</td> <td>1</td> <td>Green component</td> <td>RGB</td> </tr> <tr> <td>1</td> <td>0</td> <td>Y component</td> <td>YUV or B/W</td> </tr> <tr> <td>1</td> <td>1</td> <td>Green component</td> <td>RGB</td> </tr> </tbody> </table> <p>Note: Modes (AMOD1, AMOD0) = 00, 01, 11 are not available for OV7410P Image Sensor</p>	AMOD1	AMOD0	Output Component	Format	0	0	S-Video YO channel	Composite	0	1	Green component	RGB	1	0	Y component	YUV or B/W	1	1	Green component	RGB
AMOD1	AMOD0	Output Component	Format																				
0	0	S-Video YO channel	Composite																				
0	1	Green component	RGB																				
1	0	Y component	YUV or B/W																				
1	1	Green component	RGB																				
17	RVCVO	Output	Video Output: Output format determined by pins 38 and 39 (AMOD1, AMOD0) <table border="1"> <thead> <tr> <th>AMOD1</th> <th>AMOD0</th> <th>Output Component</th> <th>Format</th> </tr> </thead> <tbody> <tr> <td>0</td> <td>0</td> <td>CVBS signal</td> <td>Composite</td> </tr> <tr> <td>0</td> <td>1</td> <td>Red component</td> <td>RGB</td> </tr> <tr> <td>1</td> <td>0</td> <td>Cr component</td> <td>YUV or B/W</td> </tr> <tr> <td>1</td> <td>1</td> <td>Red component</td> <td>RGB</td> </tr> </tbody> </table> <p>Note: Modes (AMOD1, AMOD0) = 00, 01, 11 are not available for OV7410P Image Sensor</p>	AMOD1	AMOD0	Output Component	Format	0	0	CVBS signal	Composite	0	1	Red component	RGB	1	0	Cr component	YUV or B/W	1	1	Red component	RGB
AMOD1	AMOD0	Output Component	Format																				
0	0	CVBS signal	Composite																				
0	1	Red component	RGB																				
1	0	Cr component	YUV or B/W																				
1	1	Red component	RGB																				
18	OVDD	V _{in}	Analog power for video output (+5VDC)																				
19	G2X	Function (Default = 0)	Automatic Gain Control (AGC) gain selection. Affects range selected by HGAIN (p20). See HGAIN below. "0" - select normal AGC gain (1X) "1" - select enhanced AGC gain (2X)																				
20	HGAIN	Function (Default = 0)	Automatic Gain Control (AGC) gain range selection "0" - select normal AGC range (1X <-> 4X) "1" - select expanded AGC range (1X -> 8X) <table border="1"> <thead> <tr> <th>HGAIN</th> <th>G2X</th> <th>AGC Range</th> </tr> </thead> <tbody> <tr> <td>0</td> <td>0</td> <td>1X <-> 4X</td> </tr> <tr> <td>0</td> <td>1</td> <td>2X <-> 8X</td> </tr> <tr> <td>1</td> <td>0</td> <td>1X <-> 8X</td> </tr> <tr> <td>1</td> <td>1</td> <td>2X <-> 16X</td> </tr> </tbody> </table>	HGAIN	G2X	AGC Range	0	0	1X <-> 4X	0	1	2X <-> 8X	1	0	1X <-> 8X	1	1	2X <-> 16X					
HGAIN	G2X	AGC Range																					
0	0	1X <-> 4X																					
0	1	2X <-> 8X																					
1	0	1X <-> 8X																					
1	1	2X <-> 16X																					
21	BKLT	Function (Default = 0)	Backlight selection "0" - Disable backlight compensation "1" - Enable backlight compensation																				
22	XCLK1	CLK	Crystal clock input. Frequency is 4 x F _{sc} to meet PAL subcarrier standards																				
23	XCLK2	CLK	Crystal clock output (4 x F _{sc} for PAL = 17.73265 MHz)																				
24	PAL	Function (Default = 1)																					
25	DVDD	V _{in}	Digital power																				
26	DGND	V _{in}	Digital ground																				
27	GAMMA	Function (Default = 1)	GAMMA selection "0" - Disable GAMMA correction "1" - Enable GAMMA correction																				
28	AGCEN	Function (Default = 1)	Automatic Gain Control (AGC) selection "0" - Disable AGC "1" - Enable AGC																				
29*	AWBEN	Function (Default = 1) <i>(N/C on OV7410P/ OV7411P)</i>	Automatic White Balance selection "0" - Disable AWB "1" - Enable AWB Note: This function is not available on OV7410P/OV7411P Image Sensor. This pin is "no connect".																				

Table 1. Pin Description*(Pins designated with "*" are "no connect" in OV7410P/OV7411P sensor.)*

Pin No.	Name	Pin Type	Function/Description
30*	AWBTM	Function (Default = 0) <i>(N/C on OV7410P/ OV7411P)</i>	Automatic White Balance speed selection "0" - Select normal AWB "1" - Select "fast" AWB Note: This function is not available on OV7410P/OV7411P Image Sensor. This pin is "no connect".
31	VAXPXO	Output	Valid pixel detect output. CLK is asserted on this pin during active image period.
32	VHSYNC/MIR	Output/Function (Default = 0)	Vertical/horizontal sync output. Adding a pullup resistor on this pin enables mirror image
33	FSO/VSFR	Output/Function (Default = 0)	Vertical field/frame sync output, default to field sync. Adding a pullup resistor on this pin enables frame sync.
34	FODD/I2CEN	Output/Function (Default = 0)	Even/Odd field flag. Adding a pullup resistor on this pin enables I ² C control.
35	PALSW	Output	PAL switch clock output
36	FSI	Input	Field sync input
37	PWDN	Function	Power Down mode selection "0" - Disable power down mode "1" - Enable power down mode
38	AMOD0	Function	AMOD0 (w/AMOD1) selects output mode. Note: This function is not available on OV7410P/OV7411P Image Sensor. This pin is "no connect".
39	AMOD1	Function	AMOD1 (w/AMOD0) selects output mode. Note: This function is not available on OV7410P/OV7411P Image Sensor. This pin is "no connect".
40	HSHP	Function	Sharpness level selection "0" - select normal sharpness "1" - select x2 sharpness
41	DEVDD	V _{in}	Analog power
42	DEGNZD	V _{in}	Analog ground
43	SCL	Input/Output	I ² C control
44	SDA	Input/Output	I ² C data/address
45	VREF1	V _{ref}	Internal reference. Must be decoupled with 0.1 μF capacitor to analog ground.
46	VREF2	V _{ref}	Internal reference. Must be decoupled with 0.1 μF capacitor to analog ground.
47	VREF3	V _{ref}	Internal reference. Must be decoupled with 0.1 μF capacitor to analog ground.
48	VREF4	V _{ref}	Internal reference. Must be decoupled with 0.1 μF capacitor to analog ground.

1. Functional Description

(Note: All references to color functions apply only to OV7910P image sensor)

1.1 Video Standards

Two TV standards are implemented and available as output in the OV7910P/OV7410P/OV7411P imaging devices: PAL (B). Table 2 below shows how to configure the standard of choice. Please note

that the accuracy and stability of the crystal clock frequency is important to avoid unwanted color shift in TV/video systems.

Table 2. Standard Configuration

Standard	PAL (pin 24)	Clock	Comments
PAL	1	17.734475 MHz	clock in = 4 x Fsc

1.2 Video Formats

The OV7910P/OV7410P/OV7411P image sensors support a variety of formats including Composite (CVBS), S-Video (YO/CO), RGB components, YUV components, and B/W. Composite and S-Video signals are generated from the internal TV encoder and the RGB/YUV/BW outputs are generated from the color matrix prior to entering the encoder.

The image sensor utilizes the RG/BG Bayer pattern sending raw pixel data through the color matrix, creating RGB or YUV component signals. At the same time, YUV signals are also processed to generate both composite and S-Video signals. (Note: Color format configuration is valid only for the OV7910P image sensor)

configuration for the OV7910P/OV7410P/OV7411P image sensors. Pins AMOD0/AMOD1 (pins 38 and 39) select composite and S-Video formats. In this configuration, RVCVO (pin 17) outputs CVBS, GYYO (pin 16) outputs

the YO component of the S-Video signal, and BUCO (pin 15) outputs the CO component. Table 3 below summarizes the formats available and the settings required on the appropriate pins.

1.2.2 RGB

Setting AMOD0 = 1 (w/AMOD1 = x) selects the RGB format. In this configuration, RVCVO outputs the

Red component, GYYO outputs the Green component, and BUCO provides the Blue component.

1.2.3 YUV

Setting AMOD0=0 and AMOD1=1 configures the OV7910P/OV7410P/OV7411P sensors to operate in YUV or B/W mode. In this configuration, GYYO outputs the Y component, RVCVO provides the Cr component,

and BUCO outputs the Cb component. On the OV7410P image sensor, only the GYYO (Y component) output is valid.

Table 3. Video Format Selection

Format Type	RVCVO Output (pin 17)	GYYO Output (pin 16)	BUCO Output (pin 15)	Pin Settings
Composite + S-Video	CVBS	YO	CO	AMOD0 = 0, AMOD1 = 0
RGB Components	Red	Green	Blue	AMOD0 = 1, AMOD1 = x
YUV Components	Cr	Y	Cb	AMOD0 = 0, AMOD1 = 1
Black and White	—	Y	—	AMOD0 = 0, AMOD1 = 1 (Pins 15 & 17 are undefined on the OV7410P sensor)

1.3 Configuring the OV7910P/OV7410P/OV7411P Image Sensors for Operation

The OV7910P/OV7410P/OV7411P sensors have been designed for easy-of-use in many stand-alone applications. Most of the on-chip functions are configurable by connecting appropriate pins high (logic “1”) or low (logic “0”) through a 10k Ohm resistor. The image sensor reads the input the pins at power up, which enables user-defined default configurations.

The OV7910P/OV7410P/OV7411P imaging devices also contain an I²C interface for programmatic access sensors will enable the I²C port for access.

1.4 White Balance

The function of white balance in the OV7910P image sensor is to adjust and calibrate the image devices sensitivity on the primary (RGB) colors to match the color cast of the light source. The Auto White Balance (AWB) can be enabled or disabled either through an external pin (AWBEN, pin 29) or through the I²C port. If

able only through the I²C port. This function enables the user to define a “cooler” or “warmer” background for image capture.

1.5 Additional Picture Control

A number of functions/registers are available which enable the user to configure OV7910P/OV7410P/OV7411P image capturing parameters. These functions include Automatic Gain Control (AGC), AGC Gain, Automatic Exposure Control (AEC), GAMMA,

to all

register functions (For further details on I²C, see Section 2. “I²C Bus” on page 11). By default, the I²C port is disabled. To enable the I²C for controlling the sensors, a 10K Ohm pull-up resistor must be connected to FODD/I2CEN. With FODD/I2CEN pulled high at power-up, the OV7910P/OV7410P/OV7411P image

AWB is enabled, the image sensors continuously perform white balancing. A fast or slow mode of white balancing may be user-selected (AWBTM, pin 30). Fast AWB updates color every 2 fields while slow

white balancing updates every 16 fields.

By using the I²C port, the color temperature may be further fine tuned to the requirement of the application. Note that the “blue” (Blue and Blue bias registers) and “red” (Red and Red bias registers) bias control is available and Backlight control.

HGAIN (pin 20) may be used to set the range of AGC Gain. A “0” on HGAIN sets AGC Gain range for 1X <-> 4X, while a “1” sets the range for 1X <-> 8X. G2X (pin 19) can then be used to enhance the AGC gain range.

A “0” on G2X sets AGC gain at normal. A “1” enhances the AGC gain by 2 (Refer to Table 1, “Pin Description,” on page 2, pins 19 and 20 for further details). This function may be configured through the I²C port, as

well. GAMMA (pin 27) can be used to set the GAMMA correction. BKLT (pin 21) controls how the OV7910P/OV7410P/OV7411P image sensors manage backlight conditions. These functions may also be controlled through the I²C interface.

At power up, AGC and AEC are enabled. AGC can be disabled at power up by configuring the AGCEN pin (pin 28) as required. AEC cannot be enabled/disabled externally and must be reprogrammed through the I²C port.

1.6 Other Image Sensor Control Functions

Additional programmable functions for the OV7910P/

OV7410P/OV7411P image sensors include sharpness adjustment, brightness level fine tune, color saturation adjustment, mirror image control, and power down. All of these functions (except power down) can be configured either by an external pin or through the I²C interface.

Specifications

Table 4. Electrical parameters (0°C to 70 °C, all voltages referenced to GND)

Symbol	Descriptions	Max	Typ	Min	Units
Supply					
V _{DD}	Supply voltage (VDD, DVDD)	5.25	5.0	4.75	V
I _{DD}	Supply Current in VDDs	40	-	-	mA
I²C					
f _{scl}	SCL clock frequency	400	-	-	kHz
t _f	SDA fall time	300	-	20 + 0.1C _{sda}	ns
t _{idle}	Bus idle time	-	-	1.3	us
t _{hdsta}	START hold time	-	-	0.6	us
t _{stps}	STOP set up time	-	-	0.6	us
t _{ds}	SDA set up time	-	-	100	us
t _{dh}	SDA hold time	-	-	0	us
Clock input / Crystal Oscillator					
f _{osc}	Resonator frequency	10	-	20	MHz
	Load capacitor	-	10	-	pF
	Parallel resistance		1M		W
	Rise/fall time for external clock input	-	5	-	ns
	Duty cycle for external clock input	60		40	%
Misc. timing					
t _{SYNC}	External FSI cycle time	-	2	-	frame
t _{PU}	Chip power up time	100	-	-	us
t _{PD}	Power up delay time	-	10	-	us
t _{PZ}	Power up low-z delay	-	1000	-	ns
VTO analog video output parameters					

V _{TO} analog video output parameters						
Symbol	Descriptions	Max	Type (OV7910P)	Type (OV7410P/OV7411P)	Min	Units
V _{TO-P}	Video peak signal level	-	2.3	2.4	-	V
V _{TO-B}	Video black signal level	-	0.7	1.2	-	V
V _{SYNC}	Video sync pulse amplitude	-	0.7	0.4	-	V
R _o	Video output load		75	75		Ohm

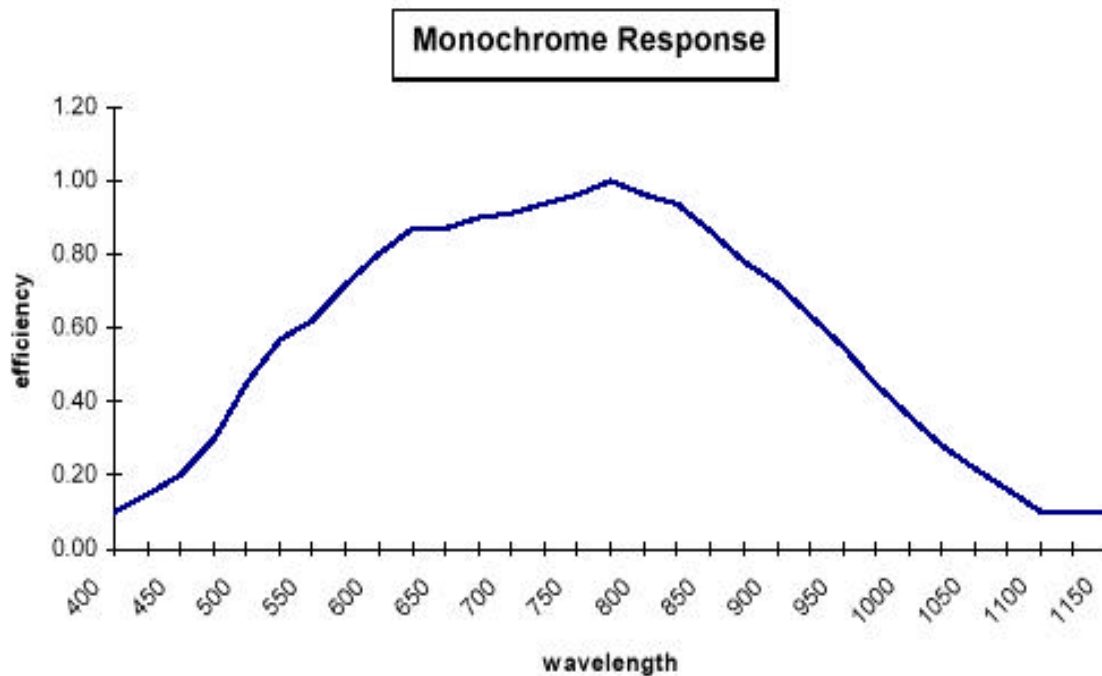
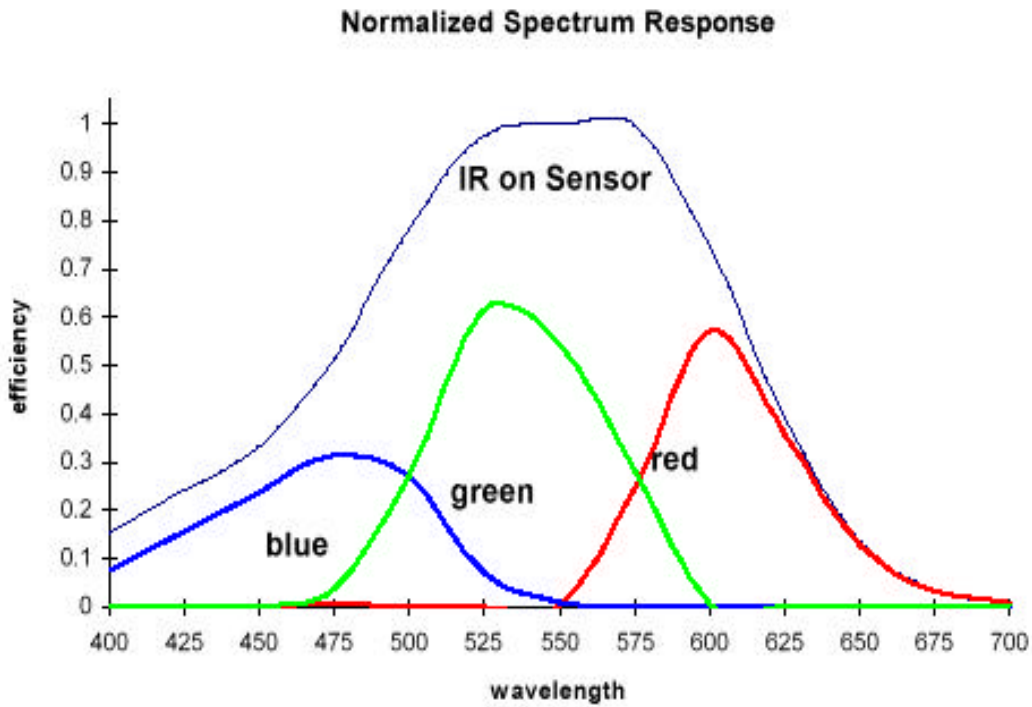

Figure 1. Spectrum Response

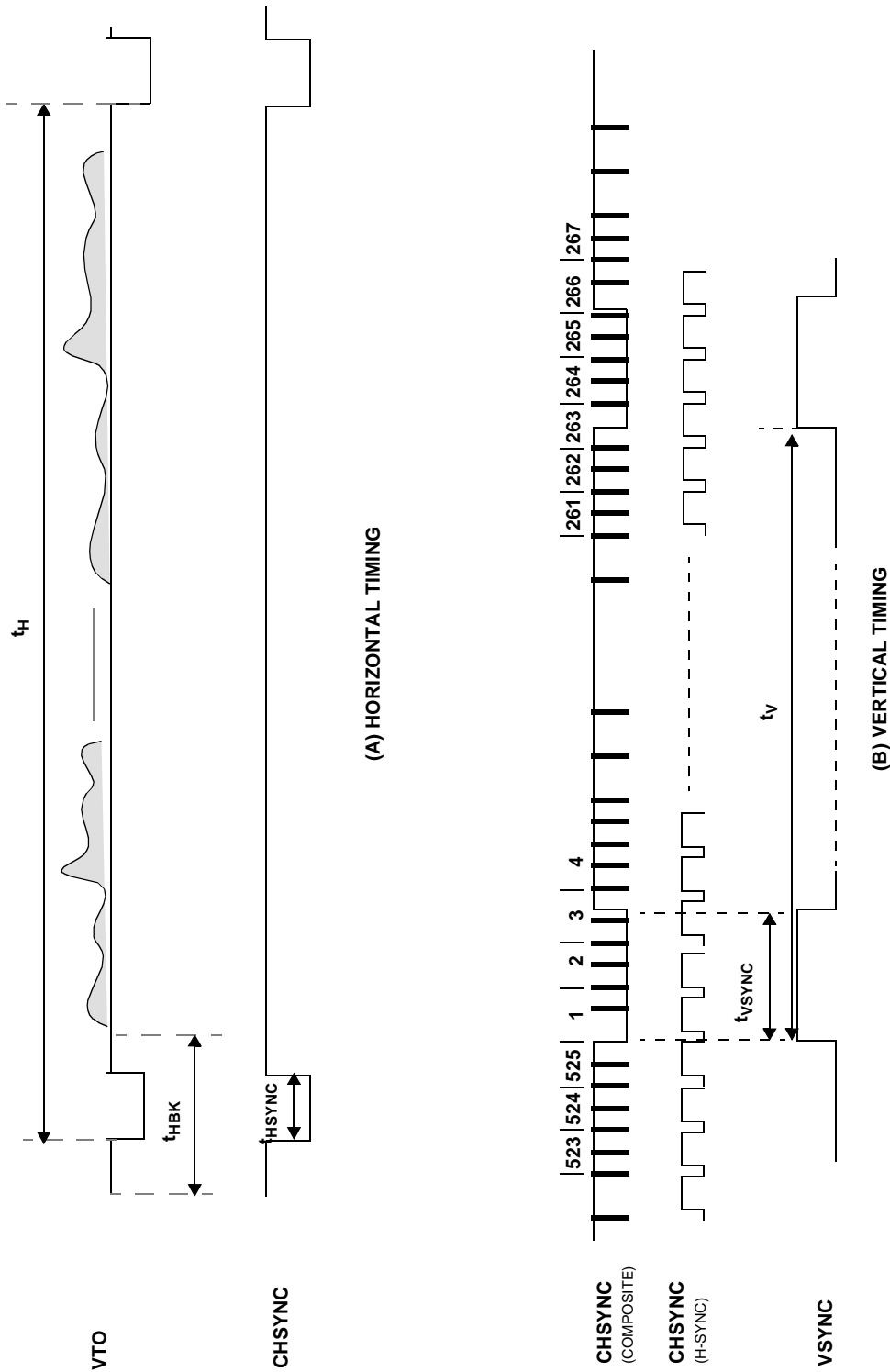

Figure 2. Video Timing Diagram

2. I²C Bus

I²C

Many of the functions and configuration registers in the OV7910P/OV7410P/OV7411P image sensors are available through the I²C high-speed serial interface. The I²C port is enabled by asserting the I2CEN line (pin 34) through a 10K ohm resistor to V_{DD}. When the rate using a 7-bit address/data transfer protocol .

capability is enabled (I2CEN = 1), the OV7910P/OV7410P/OV7411P imager operates as a slave device that supports up to 400 kbps serial transfer

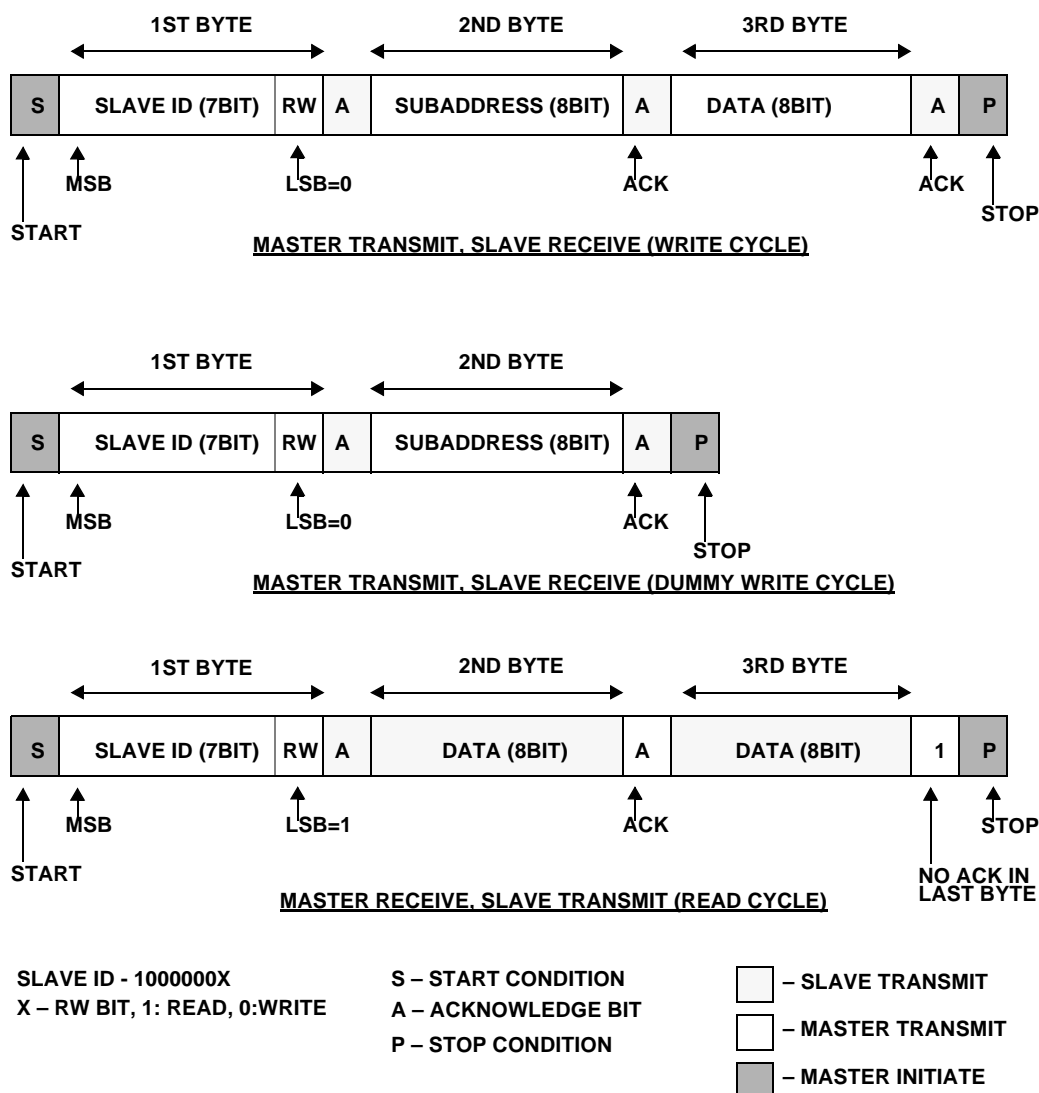

Figure 3. I²C Bus Protocol Format

2.1 I²C Bus Protocol Format

In I²C operation, the master must perform the following operations:

- **Generate the start/stop condition**
- **Provide the serial clock on SCL**
- **Place the 7-bit slave address, the RW bit, and the 8-bit subaddress on SDA**

The receiver must pull down SDA during the acknowledge bit time. During the write cycle, the OV7910P/OV7410P/OV7411P device returns the acknowledgment and, during read cycle, the master returns the acknowledgment except when the read data is the last byte. If the read data is the last byte, the master does not perform an acknowledge, indicating to the slave below).

that the read cycle can be terminated. Note that the restart feature is not supported here.

Within each byte, MSB is always transferred first. Read/write control bit is the LSB of the first byte. Standard I²C communications require only two pins: SCL and SDA. SDA is configured as open drain for bidirectional purpose. A HIGH to LOW transition on the SDA while SCL is HIGH indicates a START condition. A LOW to HIGH transition on the SDA while SCL is HIGH indicates a STOP condition. Only a master can generate START/STOP conditions.

Except for these two special conditions, the protocol that SDA remain stable during the HIGH period of the clock, SCL. Each bit is allowed to change state only when SCL is LOW (See Figure 4. Bit Transfer on the I²C Bus and Figure 5. Data Transfer on the I²C Bus

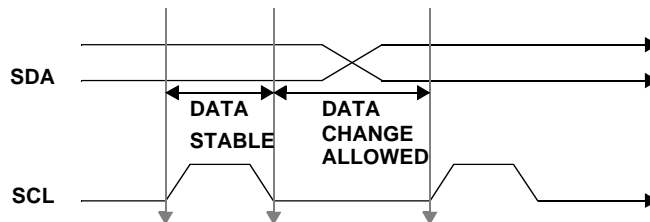
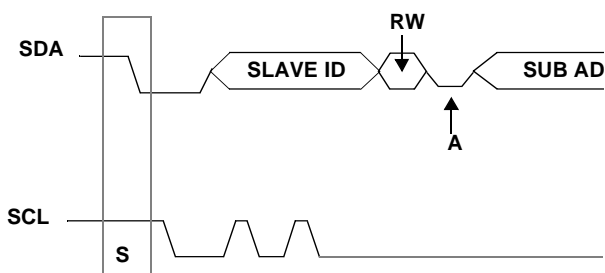

Figure 4. Bit Transfer on the I²C Bus

Figure 5. Data Transfer on the I²C Bus



The OV7910P/OV7410P/OV7411P I²C supports multi-byte write and multi-byte read. The master must supply the subaddress. in the write cycle, but not in the read cycle. Therefore, the OV7910P/OV7410P/OV7411P takes the read subaddress from the previous write cycle. In multi-byte write or multi-byte read cycles, the subaddress is automatically increment after the first data byte so that continuous locations can be accessed

in one bus cycle. A multi-byte cycle overwrites its original subaddress; therefore, if a read cycle immediately follows a multi-byte cycle, you must insert a single-byte write cycle that provides a new subaddress.

The OV7910P/OV7410P/OV7411P supports a single slave ID. The ID is preset to 80 write and 81 for read.

In the write cycle, the second byte in I²C bus is the subaddress for selecting the individual on-chip registers, and the third byte is the data associated with this register. Writing to an undefined subaddress is ignored.

In the read cycle, the second byte is the data associated with the previous stored subaddress. Reading of undefined subaddresses returns unknown data.

2.2 Register Set

The table below provides a list and description of available I²C registers contained in the OV7910P/OV7410P/OV7411P image sensor.

Table 5. I²C Registers

Subaddress (hex)	Register	Default (hex)	Read/Write	Descriptions
00	Gain[6:0]	00	RW	GC[7] - unimplemented bit, returns 'X' when read. GC[6:0] – Storage for the current AGC Gain setting. This register is updated automatically. If AGC is enabled, the internal control stores the optimal gain value in this register. IF AGC is not enabled, a "00" is stored in this register.
01	Blue[7:0]	80	RW	Storage for the current blue channel setting for white balance control. BLU[7] – "0" decrease gain, "1" increase gain. BLU[6:0] – blue channel gain balance value. Note: This function is not available on the OV7410P/OV7411P Image Sensor.
02	Red[7:0]	80	RW	Storage for the current red channel setting for white balance control. RED[7] – "0" decrease gain, "1" increase gain. RED[6:0] – red channel balance value. Note: This function is not available on the OV7410P/OV7411P Image Sensor.
03	Sat	D0	RW	SAT[7:0] – saturation adjustment. "FFh"- highest, "00h"-lowest Note: This function is not available on the OV7410P/OV7411P Image Sensor.
04	Cnt	00	RW	CTR[7:0] – contrast adjustment. "FFh"-highest, "00h"-lowest
05	Brt	80	RW	BRT[7:0] – brightness adjustment. "FFh"-highest, "00h"-lowest
06	Rsvd06	B2	RW	reserved
07	Blue Bias	20	RW	BBS[7:6] – rsvd (BBS[7:6] = 00) BBS[5:0] – blue channel bias value. This value defines the fine tune adjustment for the blue tint in the white balance control. This register is the manual control portion of the AWB control Note: This function is not available on the OV7410P/OV7411P Image Sensor.

Subaddress (hex)	Register	Default (hex)	Read/Write	Descriptions															
08	Red Bias	20	RW	RBS[7:6] – rsvd (RBS[7:6] = 01) RBS[5:0] – red channel bias value. This value defines the fine tune adjustment for the red tint in the white balance control. This register is the manual control portion of the AWB control Note: This function is not available on the OV7410P/OV7411P Image Sensor.															
09	Rsvd09	B7	RW	reserved															
0A	Rsvd0A	45	RW	reserved															
0B	Rsvd0B	—	W	reserved															
0C	Rsvd0C	—	W	reserved															
0D	Rsvd0D	4E	RW	reserved															
0E	Rsvd0E	32	RW	reserved															
0F	Rsvd0F	7A	RW	reserved															
10	version	03	R	Version															
11	Manufacture ID (H)	7F	R	MIDH[7:0] – manufacture ID high byte															
12	Manufacture ID (L)	A2	R	MIDL[7:0] – manufacture ID low byte															
13	AEC	82	RW	AEC[7:0] – Manual exposure setting. “00” = lowest, 82 = Highest															
14	Common A	9F	RW	COMA[7] - CEXP, “0” selects central exposure COMA[6:4] - rsvd COMA[3] - GAMMA, “1” selects gamma = 0.45, “0” select gamma=1.0 COMA[2] - AGCEN, “1” enables auto gain control COMA[1] - AWBEN, “1” enables auto white balance* COMA[0] - AEC enable. If AEC is enabled, the AEC register (Reg. 13) is updated automatically. If AEC is disabled, AEC register remains unchanged. *Note: COMA[1], AWBEN is not available on the OV7410P/OV7411P Image Sensor.															
15	Common B	00	RW	COMB[7] - SRST, “1” initiates soft reset. Initiate soft reset. All registers are set to default values and chip is reset to known state and resumes normal operation. This bit is automatically cleared after reset. COMB[6] - MIRR, “1” selects mirror image COMB[5] - VSFR, “1” enables frame sync output to VSYNC (pin 32), “0” enables field sync output to VSYNC COMB[4] - BKLT, “1” selects backlight exposure mode COMB[3] - FREX, “1” disables the update of exposure and gain value COMB[2] - HGAIN. Automatic Gain Control (AGC) gain range selection. See COME[6] (G2X), below. “0” - select normal AGC range (1X <-> 4X) “1” - select expanded AGC range (1X -> 8X) <table border="1" style="margin-left: 20px;"> <thead> <tr> <th>HGAIN</th> <th>G2X</th> <th>AGC Range</th> </tr> </thead> <tbody> <tr> <td>0</td> <td>0</td> <td>1X <-> 4X</td> </tr> <tr> <td>0</td> <td>1</td> <td>2X <-> 8X</td> </tr> <tr> <td>1</td> <td>0</td> <td>1X <-> 8X</td> </tr> <tr> <td>1</td> <td>1</td> <td>2X <-> 16X</td> </tr> </tbody> </table> COMB[1:0] - AMOD, select video output modes 00 - S-video and CVBS* 01 - RGB* 10 - YUV 11 - RGB* *Note: COMB[1:0] = 00, 01, 11 are not available on the OV7410P/OV7411P Image Sensor.	HGAIN	G2X	AGC Range	0	0	1X <-> 4X	0	1	2X <-> 8X	1	0	1X <-> 8X	1	1	2X <-> 16X
HGAIN	G2X	AGC Range																	
0	0	1X <-> 4X																	
0	1	2X <-> 8X																	
1	0	1X <-> 8X																	
1	1	2X <-> 16X																	
16	Common C	20	RW	COMC[7] - Smart AWB. “0” disables SMTawb, “1” enables SMTawb COMC[6] - rsvd COMC[5] - Automatic Level Control. “0” disables ALC, “1” enables ALCauto level control COMC[4:0] - rsvd															
17	Common D	34	RW	COMD[7:4] - rsvd COMD[3] - BPSHP. “0” enables sharpness control, “1” disables sharpness control COMD[2] - rsvd COMD[1] - AWBTM, “1” selects fast AWB update* COMD[0] - rsvd *Note: COMD[1], AWBTM is not available on the OV7410P/OV7411P Image Sensor.															
18	Rsvd18	A2	RW	reserved															
19	Rsvd19	66	RW	reserved															

OMNIVISION TECHNOLOGIES, Inc.

OV7910P/OV7410P/OV7411P

SINGLE IC CMOS COLOR & B/W PAL ANALOG CAMERAS

Subaddress (hex)	Register	Default (hex)	Read/Write	Descriptions
1A	Rsvd1A	73	RW	reserved
1B	Rsvd1B	D0	RW	reserved
1C	Rsvd1C	15	RW	reserved
1D	Common E	20	RW	COME[7] - rsvd COME[6] - G2XA. Automatic Gain Control (AGC) gain selection. Affects range selected by HGAIN. See COMB[2] (HGAIN), above. "0" - select normal AGC gain (1X) "1" - select enhanced AGC gain (2X) COME[5:0] - rsvd
1E	Rsvd1F	30	RW	reserved
1F	Rsvd20	28	RW	reserved
20 - 2F	Rsvd2X	N/A	RW	reserved
30	Rsvd30	80	RW	reserved
31	Rsvd31	80	RW	reserved
32	Rsvd32	80	RW	reserved
33	Rsvd33	40	RW	reserved
34	Rsvd34	80	RW	reserved
35	Rsvd35	20	RW	reserved
36	Rsvd36	20	RW	reserved
37	Rsvd37	80	RW	reserved
38	Rsvd38	80	RW	reserved
39	Rsvd39	80	RW	reserved
3A	Rsvd3A	80	RW	reserved
3B	Rsvd3B	80	RW	reserved

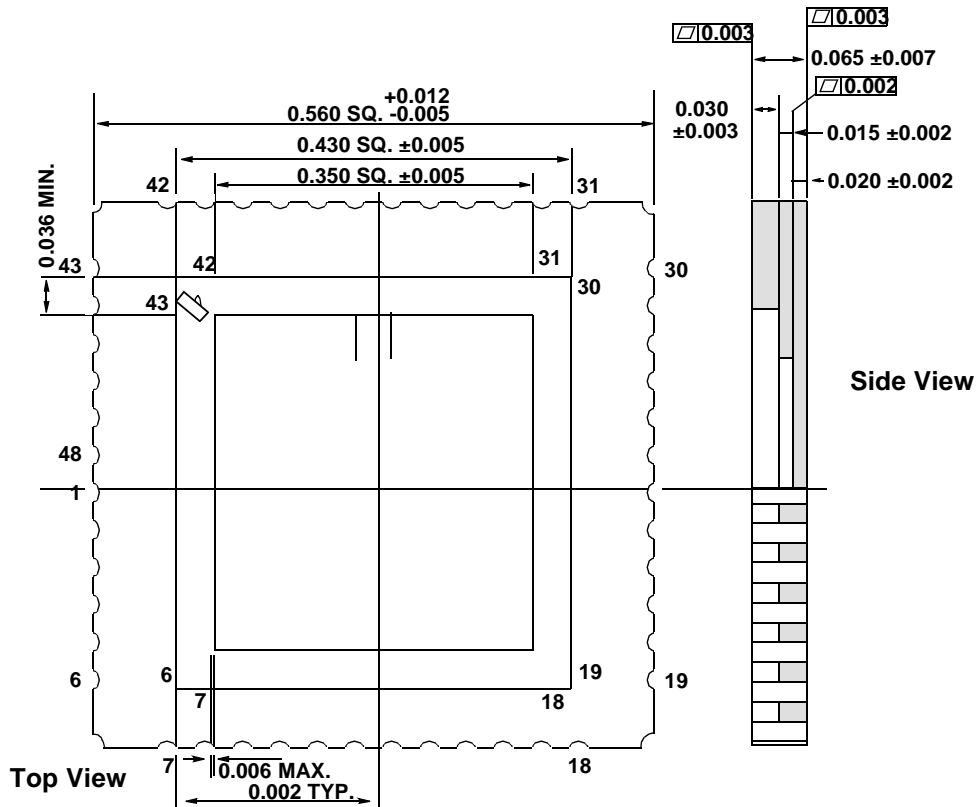
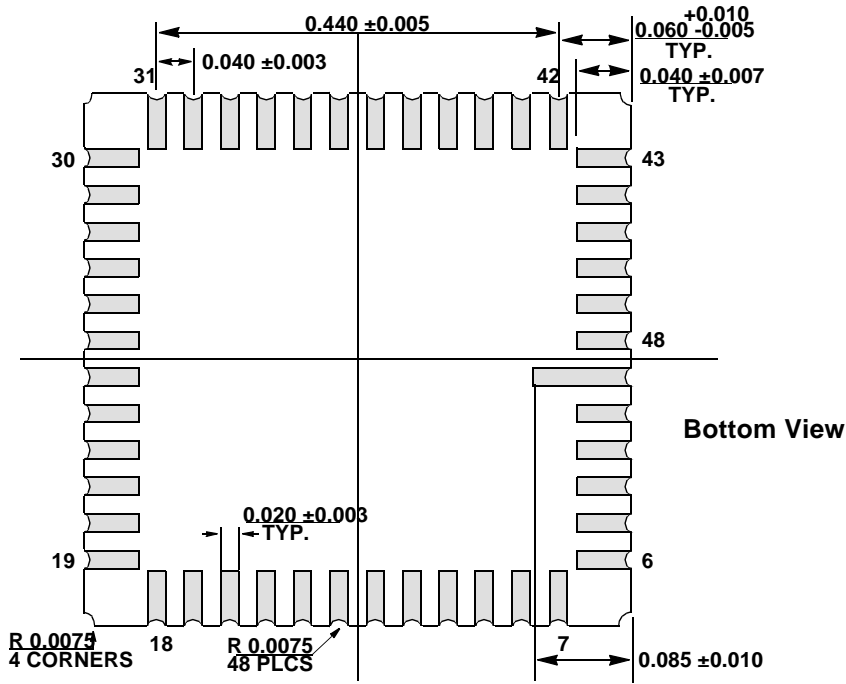

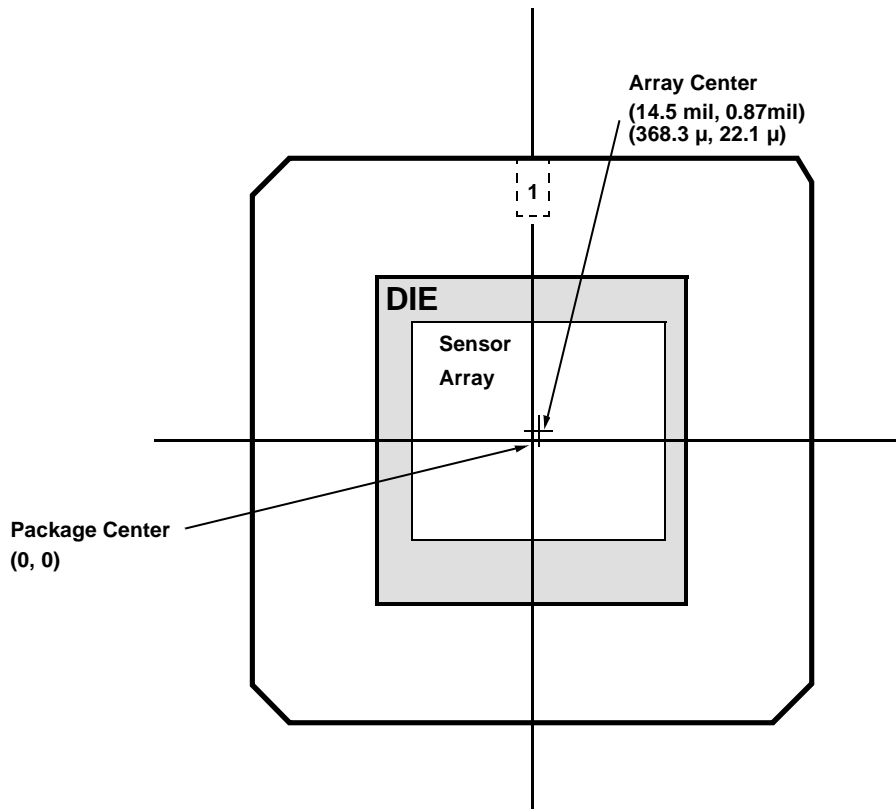

Figure 6. OV7910P/OV7410P/OV7411P Package Outline

Table 6. Ordering Information

Part Number	Description	Package
OV7910P	Color Image Sensor, PAL Analog, I ² C Bus Control	48 pin LCC
OV7410P	B/W Image Sensor, PAL Analog, I ² C Bus Control	48 pin LCC
OV7411P	High sensitivity B/W Image Sensor w/micro lenses, PAL Analog, I ² C Bus Control	48 pin LCC

Omnivision Technologies, Inc. reserves the right to make changes without further notice to any product herein to improve reliability, function, or design. Omnivision Technologies, Inc. does not assume any liability arising out of the application or use of any product or circuit described herein; neither does it convey any license under its patent rights nor the rights of others. No part of this publication may be copied or reproduced, in any form without the prior written consent of Omnivision Technologies, Inc.

Revision History

Product	Product Version	Description	Date
OV7910P/OV7410P	AA	Product Release	10/1/98
OV7910P/OV7410P	AI	Process/performance change enhancements	1/1/99
OV7910P/OV7410P	AJ	Process/performance change enhancements, I2C register changes: Regs. 03, 06, 08, x10	2/11/99
OV7910P/OV7410P	AK	Performance/manufacturability improvements	2/22/99
OV7910P/OV7410P	AK	Miscellaneous corrections	6/6/99
OV7910P/OV7410P/ OV7411P	AK	Add OV7411P release	6/17/99