



OZ6812



FEATURES

The OZ6812 is a PCMCIA R2/CardBus controller, providing the most advanced design flexibility for PC Cards that interface with advanced notebook designs.

- ACPI-PCI Bus Power Management Interface Specification Rev 1.1 Compliant
- Supports OnNow LAN wakeup, OnNow Ring Indicate, PCI CLKRUN#, PME#, and CardBus CCLKRUN#
- Compliant with PCI specification V2.2, 1998 PC Card Standard 7.0
- Yenta™ PCI to PCMCIA CardBus Bridge register compatible
- ExCA (Exchangeable Card Architecture) compatible registers mappable in memory and I/O space
- Intel™ 82365SL PCIC Register Compatible
- Supports PCMCIA_ATA Specification
- Supports 5V/3.3V PC Cards and 3.3V CardBus cards
- Supports single PC Card or CardBus slot with hot insertion and removal
- Supports multiple FIFOs for PCI/CardBus data transfer
- Supports Direct Memory Access for PC/PCI and PCI/Way on PC Card socket
- Programmable interrupt protocol: PCI, PCI+ISA, PCI/Way, or PC/PCI interrupt signaling modes
- Win'98 IRQ and PC-98/99 compliant
- Parallel or Serial interface for socket power control devices including Micrel and TI
- Zoomed Video Support
- Integrated PC 98/99 -Subsystem Vendor ID support, with auto lock bit
- LED Activity Pins

ORDERING INFORMATION

OZ6812T - 144pin LQFP

OZ6812B - 144pin Mini-BGA

GENERAL DESCRIPTION

The OZ6812 is an ACPI and PC98/99 logo certified, high performance, single slot PC Card controller with a synchronous 32-bit bus master/target PCI interface. This PC Card to PCI bridge host controller is compliant with the

ACPI CardBus Controller

1998 PC Card Standard. This standard incorporates the new 32-bit CardBus while retaining the 16-bit PC Card specification as defined by PCMCIA release 2.1. CardBus is intended to support "temporal" add-in functions on PC Cards, such as Memory cards, Network interfaces, FAX/Modems and other wireless communication cards, etc. The high performance and capability of the CardBus interface will enable the development of many new functions and applications.

The OZ6812 CardBus controller is compliant with the latest ACPI-PCI Bus Power Management Interface Specification. It supports all four power states and the PME# function for maximum power savings and ACPI compliance. The device also provides a power-down mode to allow host software to reduce power consumption further by stopping internal clock distribution as well as the PC Card socket clock. In addition, an advanced CMOS process is utilized to minimize system power consumption.

The OZ6812 single PCMCIA socket supports 3.3V/5V 8/16-bit PC Card R2 card or 32-bit CardBus R3 card. The R2 card support is compatible with the Intel 82365SL PCIC controller, and the R3 card support is fully compliant with the 1998 PC Card Standard CardBus specification. The OZ6812 is a stand alone device, which means that it does not require an additional buffer chip for the PC Card socket interface. In addition, the OZ6812 supports dynamic PC Card hot insertion and removal, with auto configuration capabilities.

The OZ6812 is fully compliant with the 33Mhz PCI Bus specification, V2.2. It supports a master device with internal CardBus direct data transfer. The OZ6812 implements a FIFO data buffer architecture between the PCI bus and CardBus socket interface to enhance data transfers to CardBus devices. The bi-directional FIFO buffer (composed of 16 double words) permits the OZ6812 to accept data from a target bus (PCI or CardBus interface) while simultaneously transferring data. This architecture not only speeds up data transfers but also prevents system deadlocks.



Functional Block Diagram

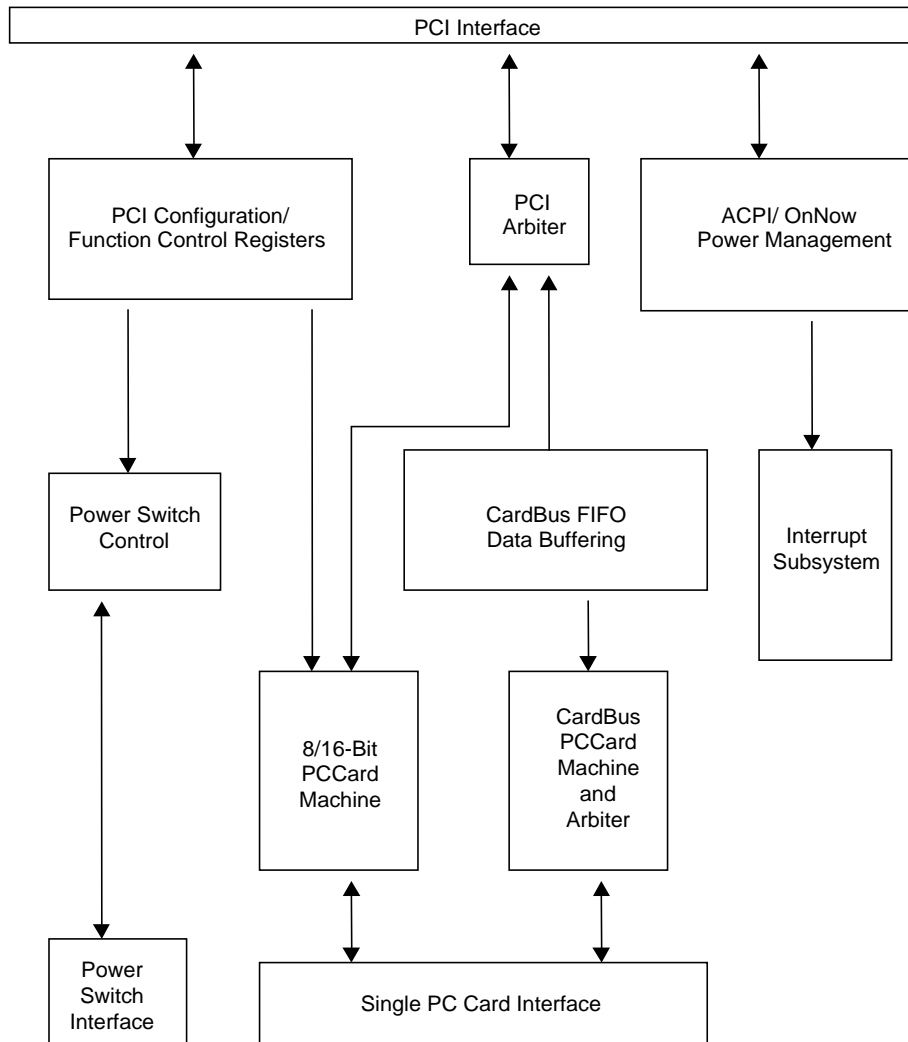

Pin List

Bold Text = Normal Default Pin Name

PCI Bus Interface Pins

Pin Name	Description	Pin Number		Input	Type	Power Rail	Drive
		LQFP	BGA				
AD[31:0]	PCI Bus Address Input / Data: These pins connect to PCI bus signals AD[31:0]. A Bus transaction consists of an address phase followed by one or more data phases.	3-5, 7-11, 15-17, 19, 23-26, 38-41, 43, 45-47, 49, 51-57	D4, B1, C2-1, D2, E4, D1, E3, F3, F1, F2, G1, H2-3, J1, H4, M2, K4, N2, M3, N3, K5, N4, L5, N5, L6, N6, M6, L7, N7, M7, K7	TTL	I/O	PCI_Vcc	PCI Spec
C/BE[3:0]#	PCI Bus Command / Byte Enable: The command signaling and byte enables are multiplexed on the same pins. During the address phase of a transaction, C/BE[3:0]# are interpreted as the bus commands. During the data phase, C/BE[3:0]# are interpreted as byte enables. The byte enables are to be valid for the entirety of each data phase, and they indicate which bytes in the 32-bit data path are to carry meaningful data for the current data phase.	12, 27, 37, 48	E2, J2, N1, M5	TTL	I/O	PCI_Vcc	PCI Spec
FRAME#	Cycle Frame: This input indicates to the OZ6812 that a bus transaction is beginning. While FRAME# is asserted, data transfers continue. When FRAME# is de-asserted, the transaction is in its final phase.	28	K1	TTL	I/O	PCI_Vcc	PCI Spec
IRDY#	Initiator Ready: This input indicates the initiating agent's ability to complete the current data phase of the transaction. IRDY# is used in conjunction with TRDY#.	29	J3	TTL	I/O	PCI_Vcc	PCI Spec
TRDY#	Target Ready: This output indicates target Agent's the OZ6812's ability to complete the current data phase of the transaction. TRDY# is used in conjunction with IRDY#.	31	L1	TTL	I/O	PCI_Vcc	PCI Spec
STOP#	Stop: This output indicates the current target is requesting the master to stop the current transaction.	33	K3	TTL	I/O	PCI_Vcc	PCI Spec
IDSEL	Initialization Device Select: This input is used as a chip select during configuration read and write transactions. This is a point-to-point signal. IDSEL can be used as a chip select during configuration read and write transactions.	13	E1	TTL	I	PCI_Vcc	PCI Spec
DEVSEL#	Device Select: This output is driven active LOW when the PCI address is recognized as supported, thereby acting as the target for the current PCI cycle. The Target must respond before timeout occurs or the cycle will terminate.	32	J4	TTL	I/O	PCI_Vcc	PCI Spec
PERR#	Parity Error: The output is driven active LOW when a data parity error is detected during a write phase.	34	M1	-	TO	PCI_Vcc	PCI Spec
SERR#	System Error: This output is driven active LOW to indicate an address parity error.	35	L2	-	TO	PCI_Vcc	PCI Spec

OZ6812

Pin Name	Description	Pin Number		Input	Type	Power Rail	Drive
		LQFP	BGA				
PAR	Parity: This pin generates PCI parity and ensures even parity across AD[31:0] and C/BE[3:0]#. During the address phase, PAR is valid after one clock. With data phases, PAR is stable one clock after a write or read transaction.	36	L3	TTL	I/O	PCI_Vcc	PCI Spec
PCI_CLK	PCI Clock: This input provides timing for all transactions on the PCI bus to and from the OZ6812. All PCI bus signals, except RST#, are sampled and driven on the rising edge of PCI_CLK. This input can be operated at frequencies from 0 to 33 MHz.	21	G4	-	I	PCI_Vcc	-
RST#	Device Reset: This input is used to initialize all registers and internal logic to their reset states and place most OZ6812 pins in a HIGH-impedance state.	20	G2	-	I	AUX_Vcc	-
GNT#	Grant: This signal indicates that access to the bus has been granted.	2	B2	TTL	I	PCI_Vcc	PCI Spec
REQ#	Request: This signal indicates to the arbiter that the OZ6812 requests use of the bus.	1	A1	-	TO	PCI_Vcc	PCI Spec

Power Control and General Interface Pins

Pin Name	Description	Pin Number		Input	Type	Power Rail	Drive
		LQFP	BGA				
RI_OUT/ PME#	Ring Indicate Out: This pin is Ring Indicate when the following occurs while O ₂ Mode Control B Register (index 2Eh) bit 7 is set to 1: 1) Power Control (Index+02h) bit 7 set to 1 2) Interrupt and General Control (Index+03h) bit 7 set to 1 3) PCI O2Micro Control 2 (Offset: D4h) bit X = 0 Power Management Event: A power management event is the process by which the OZ6812 can request a change of its power consumption state. Usually, a PME occurs during a request to change from a power saving state to the fully operational state.	59	M8	-	TO	Aux_Vcc	4mA
SPKR_OUT#	Speaker Output: This output can be used to support PC Card audio output. See O2 Mode E Register (Index + 3Eh), bit 1.	62	K8	TTL	I/O	Aux_Vcc	12mA
MF[6:0]	Multifunction Terminal [6:0]: See PCI Multifunction MUX Register (Offset:08h).	69-67, 65-64, 61-60	L10, K9, N11, L9, N10-9, L8	TTL	I/O	Aux_Vcc	12mA
SUSPEND#	Suspend: This signal is used to protect the internal registers from clearing when the PCI RST# signal is asserted. When low, this signal is used to mask the PCI RESET during suspend. This pin can be used during suspend to prevent controller reset.	70	N12	TTL	I	Aux_Vcc	-

OZ6812

Pin Name	Description	Pin Number		Input	Type	Power Rail	Drive
		LQFP	BGA				
VPPD0/ SLATCH	<p>VPPD0: This power input is used with parallel power control chip</p> <p>SLATCH: This output controls a serial interface power control chip.</p>	71	M11	TTL	I/O	Aux_Vcc	12mA
VPPD1	VPPD1: This power input is used a parallel power interface chip.	72	L11	-	TO	Aux_Vcc	12mA
VCCD0#/ SDATA	<p>VCCD0#: Rail power inputs for use with a parallel power control chip.</p> <p>Serial Data: This pin serves as output DATA pin when used with a serial interface of serial power control chip.</p>	73	N13	TTL	I/O	Aux_Vcc	12mA
VCCD1#/ SCLK	<p>VCCD1#: Rail power inputs for use with a parallel power control chip.</p> <p>Serial Clock: The input is used as a reference clock (10-100kHz, usually 32kHz) to control a serial power control chips. By setting PCI O2Micro Control 2 register (Offset:D4h) bit 13 to 1, SCLK is an output. Default is input mode.</p>	74	M12	TTL	I/O	Aux_Vcc	12mA

PC Card Socket Interface Pins

Refer to PCI Bus Interface pin descriptions for details on CardBus function.

EXCEPTIONS: CCD[2:1]#, AUDIO, CSTSCHG, CVS[2:1]

Pin Name	Description	Pin Number		Input	Type	Power Rail	Drive
		LQFP	BGA				
REG#/CCBE3#	Register Access: During PC Card memory cycles, this output chooses between Attribute and Common Memory. During I/O cycles for non-DMA transfers, this signal is active (low). During ATA mode, this signal is always inactive. For DMA cycles on the OZ6812 to a DMA-capable card, REG# becomes DACK to the PCMCIA card. CardBus Command Byte Enable: In CardBus mode, this pin is the CCBE3#.	125	B8	TTL	I/O	Socket_Vcc	CardBus spec.
A[25:24]/CAD[19, 17]	Address: PC Card socket address 25:24 outputs. CardBus Address/Data: CardBus mode, these pins are the CAD bits 19 and 17.	116, 113	B10, B11	TTL	I/O	Socket_Vcc	CardBus spec.
A23/CFRAME#	Address: PC Card socket address 23 output. CardBus Frame: In CardBus mode, this pin is the CFRAME# signal.	111	D10	TTL	I/O	Socket_Vcc	CardBus spec.
A22/CTRDY#	Address: PC Card socket address 22 output. CardBus Target Ready: In CardBus mode, this pin is the CTRDY# signal.	109	A13	TTL	I/O-PU	Socket_Vcc	CardBus spec.
A21/CDEVSEL#	Address: PC Card socket address 21 output. CardBus Device Select: In CardBus mode, this pin is the CDEVSEL# signal.	107	C12	TTL	I/O-PU	Socket_Vcc	CardBus spec.
A20/CSTOP#	Address: PC Card socket address 20 output. CardBus Stop: In CardBus mode, this pin is the CSTOP# signal.	105	D11	TTL	I/O-PU	Socket_Vcc	CardBus spec.
A19/CBLOCK#	Address: PC Card socket address 19 output. CardBus Lock: In CardBus mode, this signal is the CBLOCK# signal used for locked transactions.	103	C13	TTL	I/O-PU	Socket_Vcc	CardBus spec.
A18/RFU	Address: PC Card socket address 18 output. Reserved: In CardBus mode, this pin is reserved for future use.	100	D13	TTL	TO	Socket_Vcc	CardBus spec.
A17/CAD16	Address: PC Card socket address 17 output. CardBus Address/Data: In CardBus mode, this pin is the CAD bit 16.	98	F10	TTL	I/O	Socket_Vcc	CardBus spec.
A16/CCLK#	Address: PC Card socket address 16 output. CardBus Clock: In CardBus mode, this pin supplies the clock to the inserted card.	108	C11	TTL	I/O	Socket_Vcc	CardBus spec.

OZ6812

Pin Name	Description	Pin Number		Input	Type	Power Rail	Drive
		LQFP	BGA				
A15/ CIRDY#	Address: PC Card socket address 15 output. CardBus Initiator Ready: In CardBus mode, this pin is the CIRDY# signal.	110	B12	TTL	I/O- PU	Socket _Vcc	CardBus spec.
A14/ CPERR#	Address: PC Card socket address 14 output. CardBus Parity Error: CardBus mode, this pin is the CPERR# signal.	104	E10	TTL	I/O- PU	Socket _Vcc	CardBus spec.
A13/ CPAR	Address: PC Card socket address 13 output. CardBus Parity: In CardBus mode, this pin is the CPAR signal.	101	E11	TTL	I/O	Socket _Vcc	CardBus spec.
A12/ CCBE2#	Address: PC Card socket address 12 output. CardBus Command/Byte Enable: In CardBus mode, this pin is the CCBE2# signal.	112	A12	TTL	I/O	Socket _Vcc	CardBus spec.
A[11:9]/ CAD [12,9,14]	Address: PC Card socket address 11:9 output. CardBus Address/Data: In CardBus mode, these pins are the CAD bits 12, 9 and 14.	95, 89, 97	F12, H12, E13	TTL	I/O	Socket _Vcc	CardBus spec.
A8/ CCBE1#	Address: PC Card socket address 8 output. CardBus Command/Byte Enable: In CardBus mode, this pin is the CCBE1# signal.	99	E12	TTL	I/O	Socket _Vcc	CardBus spec.
A[7:0]/ CAD[18] [20:26]	Address: PC Card socket address 7:0 outputs. CardBus Address/Data: In CardBus mode, these pins are the CAD bits 18 and 20:26.	115, 118, 120, 121, 124, 127, 128, 129	A11-10, B9, A9-7, B7, D7	TTL	I/O	Socket _Vcc	CardBus spec.
D15/ CAD8	Data: PC Card socket I/O data bit 15. CardBus Address/Data: In CardBus mode, this pin is the CAD bit 8.	87	H11	TTL	I/O	Socket _Vcc	CardBus spec.
D14/ RFU	Data: PC Card socket I/O data bit 14. Reserved: In CardBus mode, this pin is reserved for future use.	84	J12	TTL	I/O	Socket _Vcc	CardBus spec.
D[13:3]/ CAD[6, 4, 2, 31, 30, 28, 7, 5, 3, 1, 0]	Data: PC Card socket I/O data bits 13:3. CardBus Address/Data: In CardBus mode, this pin is the CAD bit 6 4, 2, 31, 30, 28, 7, 5, 3, 1, and 0, respectively.	82, 80, 77, 144, 142, 140, 85, 83, 81, 79, 76	K13-12, L12, C3, A2, D5, J13, J11, J10, L13, M13	TTL	I/O	Socket _Vcc	CardBus spec.
D2/ RFU	Data: PC Card socket I/O data bit 2. Reserved: In CardBus mode, this pin is reserved for future use.	143	B3	TTL	I/O	Socket _Vcc	CardBus spec.
D[1:0]/ CAD[29,27]	Data: PC Card socket I/O data bits 1:0. CardBus Address/Data: In CardBus mode, these pins are the CAD bits 29 and 27, respectively.	141, 139	C4, A3	TTL	I/O	Socket _Vcc	CardBus spec.
OE#/ CAD11	Output Enable: This output goes active (low) to indicate a memory read from the OZ6812 to PC Card. CardBus Address/Data: In CardBus mode, this pin is the CAD bit 11.	92	G12	TTL	I/O	Socket _Vcc	CardBus spec.
WE#/ CGNT#	Write Enable: This output goes active (low) to indicate a memory write from the OZ6812 to the PC Card socket. CardBus Grant: In CardBus mode, this pin is the CGNT# signal.	106	B13	TTL	TO	Socket _Vcc	CardBus spec.

OZ6812

Pin Name	Description	Pin Number		Input	Type	Power Rail	Drive
		LQFP	BGA				
IORD#/ CAD13	I/O Read: This output goes active (low) for I/O reads from the OZ6812 to the socket. CardBus Address/Data: In CardBus mode, this pin is the CAD bit 13.	93	G10	TTL	I/O	Socket _Vcc	CardBus spec.
IOW#/ CAD15	I/O Write: This output goes active (low) for I/O writes from the OZ6812 to the socket. CardBus Address/Data: In CardBus mode, this pin is the CAD bit 15.	96	F11	TTL	I/O	Socket _Vcc	CardBus spec.
WP/ IOIS16#/ CCLKRUN#	Write Protect / I/O is 16-Bit: In Memory mode, this input indicates the status of the write protect switch on the PC Card. In I/O mode, this input indicates the size of current data transfer on the PC Card. CardBus Clock Run: In CardBus mode, this pin is the CCLKRUN# signal, which starts and stops the CardBus CCLK. To enable the CLKRUN# signal, ExCA register 3Bh bit[3:2] must be enabled.	136	A4	TTL	I/O-PU	Socket _Vcc	CardBus spec.
INPACK#/ CREQ#	Input Acknowledge: The INPACK# function is not applicable in PCI bus environments. This pin is provided for Legacy card compatibility. CardBus Request: In CardBus mode, this pin is the CREQ# signal.	123	C8	-	I-PU	Socket _Vcc	CardBus spec.
RDY/IREQ#/ CINT#	Ready / Interrupt Request: In Memory mode, this input indicates that the card is ready or busy. In I/O mode, this input indicates a card interrupt request. CardBus Interrupt: In CardBus mode, this pin is the CINT# signal. This signal is active-low and level-sensitive.	132	C6	-	I-PU	Socket _Vcc	CardBus spec.
WAIT#/ CSERR#	Wait: This pin is driven by the PC Card to delay completion of the current cycle. CardBus System Error: In CardBus mode, this pin is the CSERR# signal.	133	A5	TTL	I-PU	Socket _Vcc	CardBus spec.
CD[2:1]/ CCD[2:1]#	Card Detect: These inputs indicate a card is present in the socket. They are internally pulled high to AUX_VCC. CardBus Card Detect: In CardBus mode, these inputs are used with CVS[2:1] to detect presence and type of card.	137, 75	C5, K10	TTL	I-PU- Schmitt	Aux_Vcc	CardBus spec.
CE2#/ CAD10	Card Enable 2: This pin is driven low to control byte/word card access. CE2# enables odd-numbered address bytes. CardBus Address/Data: In CardBus mode, this pin is the CAD bit 10.	91	G13	TTL	I/O	Socket _Vcc	CardBus spec.
CE1#/ CCBE0#	Card Enable 1: This pin is driven low to control byte/word card access. CE1# enables even-numbered address bytes. When configured for 8-bit cards, CE1# is active and A0 is used to indicate access of odd- or even-numbered bytes. CardBus Command/Byte Enable: In CardBus mode, this pin is the CCBE0# signal.	88	H13	TTL	I/O	Socket _Vcc	CardBus spec.

OZ6812

Pin Name	Description	Pin Number		Input	Type	Power Rail	Drive
		LQFP	BGA				
RESET/ CRST#	<p>Reset: This active high output resets the card. To prevent reset glitches, this signal is high-impedance unless a card is seated in the socket, card power is applied, and the card's interface signals are enabled.</p> <p>CardBus Reset: In CardBus mode, this pin is the CRST# output.</p>	119	C9	TTL	TO	Socket _Vcc	CardBus spec.
BVD2/SPKR#/ LED / CAUDIO	<p>Battery Voltage Detect 2 / Speaker / LED: In Memory mode, this input serves as the BVD2 (battery warning status) input. In I/O mode, this input can be configured as the card's SPKR# audio input or drive-active LED input.</p> <p>CardBus Audio: In CardBus mode, this pin is the CAUDIO input.</p>	134	D6	-	I-PU	Socket _Vcc	-
BVD1/ STSCHG#/R1#/ CSTSCHG	<p>Battery Voltage Detect 1 / Status Change / Ring Indicate: In Memory mode, this is the BVD1 (battery-dead status) input. In I/O mode, this is the STSCHG# input indicating that the card's internal status has changed, or the ring indicates input for wakeup-on-ring system power management support. See bit 7 of the Interrupt and General Control register (03h).</p> <p>CardBus Status Change: In CardBus mode, this pin is the CSTSCHG. This pin can be used to generate PME#.</p>	135	B5	-	I-PU	Socket _Vcc	-
VS[2:1]/ CVS[2:1]	<p>Voltage Sense: These pins are used in conjunction with CD[2:1] to determine the type and voltage of a card. These pins are internally pulled high to AUX_VCC. See Table 1.</p> <p>CardBus Voltage Sense: In CardBus mode, these pins are the CVS[2:1] pins.</p>	117, 131	D9, B6	TTL	I/O-PU	Aux_Vcc	CardBus spec.
SOCKET_VCC	<p>Socket Power: These pins are the power rail input for the socket interface control logic. These pins can be 0, 3.3, or 5 V,. The socket interface outputs will operate at the voltage applied to these pins.</p>	90, 126	G11, C7	-	PWR	-	-

OZ6812

Power, Ground, and Reserved Pins

Pin Name	Description	Pin Number		Input	Type	Power Rail	Drive
		LQFP	BGA				
Aux_VCC	Auxiliary VCC: This pin is connected to the system's 3.3/5V power supply. For the device to 5V tolerant, connect to +5V power.	63	M9	-	PWR	-	-
CORE_VCC	CORE_VCC: This pin provides power to the core circuitry of the OZ6812. It must be connected to a 3.3V power supply.	14, 66, 86, 102, 122, 138	F4, M10, H10, D12, D8, B4	-	PWR	-	-
PCI_VCC	PCI Bus VCC: These pins can be connected to either a 3.3V or 5V power supply. The PCI bus interface will operate at the voltage applied to these pins, independent of the voltage applied to other OZ6812 pin groups.	18, 30, 44, 50	G3, K2, M4, K6	-	PWR	-	-
GND	System Ground	6, 22, 42, 58, 78, 94, 114, 130	D3, H1, L4, N8, K11, F13, C10, A6	-	GND	-	-

Legend

I/O Type	Description
I	Input Pin
I-PU	Input pin with internal pull-up
I-PU Schmitt	Input pin with internal pull-up and Schmitt trigger
O	Output
OD	Open-drain
TO	Tri-state output
TO-PU	Tri-state output with internal pull-up
OD-PU	Open-drain output with internal pull-up
PWR	Power pin

Power Rail	Source of Output's Power
1	AUX_VCC: outputs powered from AUX_VCC
2	SOCKET_VCC: outputs powered from the socket
3	PCI_VCC: outputs powered from PCI bus power supply
4	CORE_VCC: outputs powered from the CORE_VCC

Package Information - 144 Pin LQFP

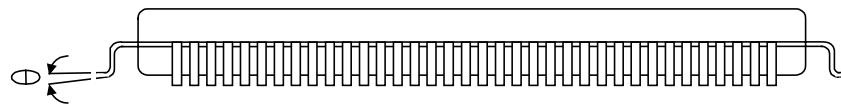
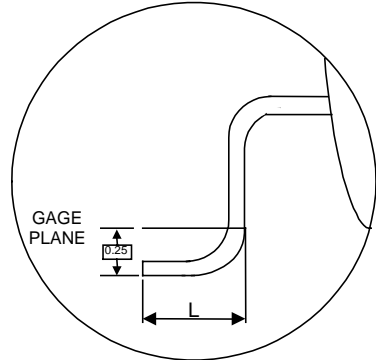
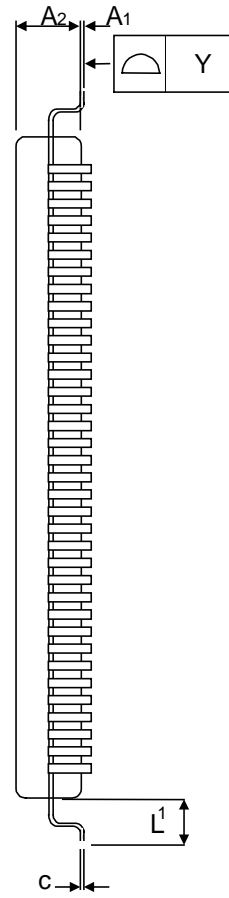
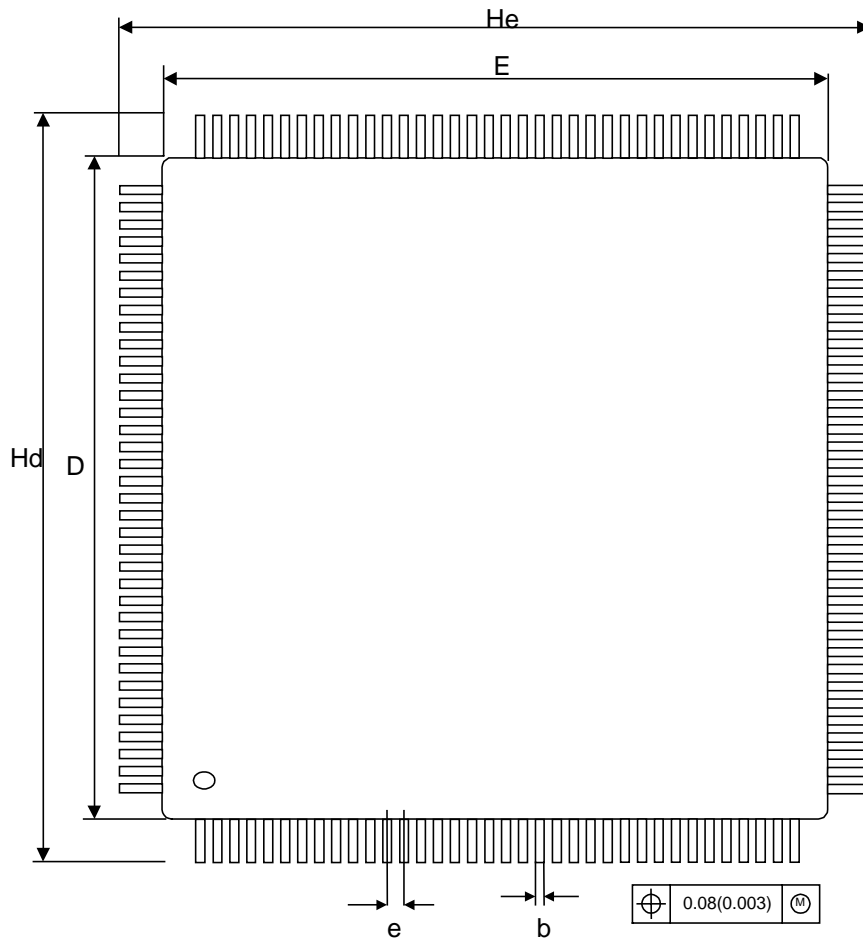

SYMBOL	MILLIMETER			INCH		
	MIN.	NOM.	MAX.	MIN.	NOM.	MAX.
A1	0.05	0.10	0.15	0.002	0.004	0.006
A2	1.35	1.40	1.45	0.053	0.055	0.057
b	0.17	0.22	0.27	0.007	0.009	0.011
c	0.090		0.200	0.004		0.008
D		20.00			0.787	
E		20.00			0.787	
e		0.50			0.020	
Hd		22.00			0.866	
He		22.00			0.866	
L	0.45	0.60	0.75	0.018	0.024	0.030
L1		1.00			0.039	
Y			0.08			0.003
θ	0		7	0		7

144 Pin Mini - BGA

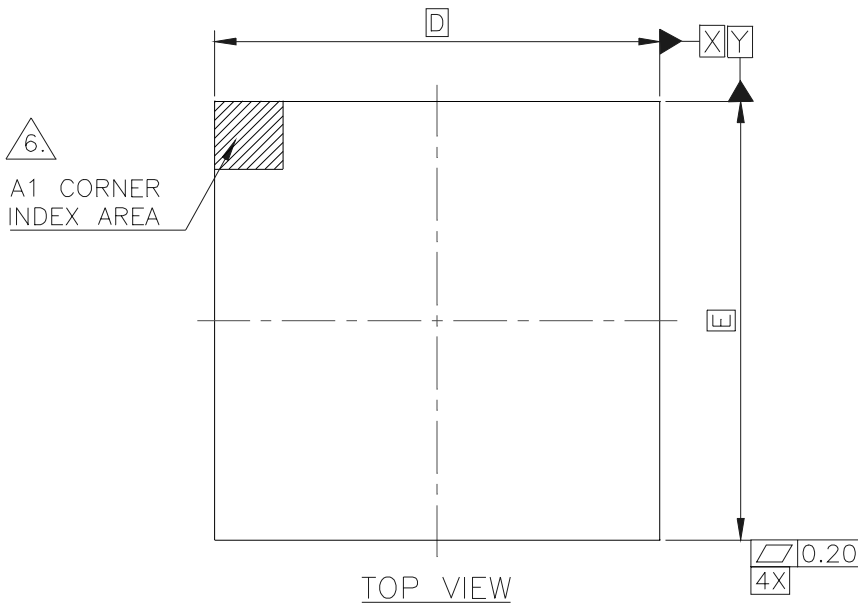

PACKAGE SPECIFICATION			
SYMBOL	MIN	NOM	MAX
D	12.80	13.00	13.20
E	12.80	13.00	13.20
D1		9.60	
E1		9.60	
e		0.80	
A	1.24	1.34	1.44
A1	0.33	0.38	0.43
A2	0.55	0.60	0.65
c	0.32	0.36	0.40
b	0.43	0.48	0.53
G		1.70	
G1		1.70	
aaa		0.12	
bbb		0.10	
ccc		0.10	
M1		13	
M2		13	
N		169	

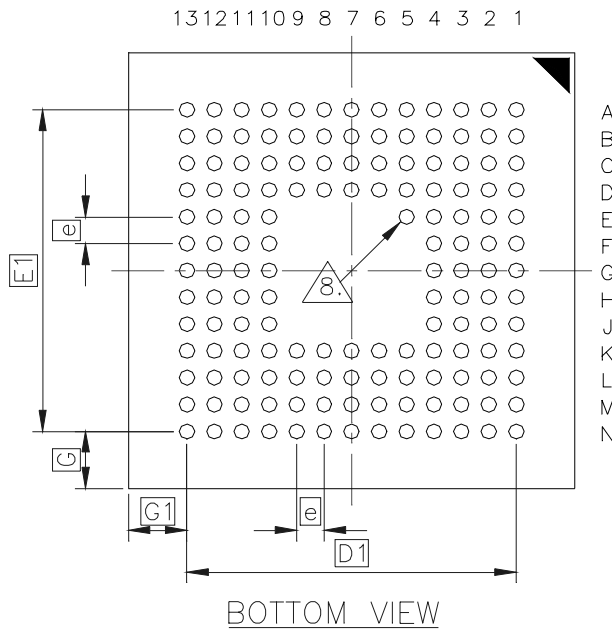

- NOTES:
1. DIMENSIONING AND TOLERANCING PER ASME Y14.5M-1994.
 2. "e" REPRESENTS THE SOLDER BALL GRID PITCH.
 3. "N" REPRESENTS THE MAXIMUM NUMBER OF SOLDER BALLS FOR MATRIX SIZE M1 AND M2.
- ▲ DIMENSION "b" IS MEASURED AT THE MAXIMUM SOLDER BALL DIAMETER AFTER REFLOW AND PARALLEL TO PRIMARY DATUM Z, THE ORIGINAL SOLDER BALL DIAMETER IS 0.45 mm.
- ▲ PRIMARY DATUM Z AND SEATING PLANE ARE DEFINED BY THE SPHERICAL CROWNS OF THE SOLDER BALLS.
- ▲ A1 CORNER MUST BE IDENTIFIED BY INK MARK, METALLIZED MARKINGS, IDENTATION OR OTHER FEATURE OF PACKAGE BODY, LID OR INTEGRAL HEATSLUG, ON THE TOP SURFACE OF THE PACKAGE.
7. SOLDER BALL DEPOPULATION IS ALLOWED. DEPOPULATION IS THE OMISSION OF BALLS FROM A FULL MATRIX (M1 OR M2).
- ▲ BALL PAD A1 CORNER INDICATOR (NC) SOLDER BALL

