

## QR/P8 SERIES

Ultra-small Rectangular Multi-electrode solderless Connectors for Rack and Panel Applications

### General

QR/P8 Series is a series of small connectors for rack and panel application. This is a smaller-size version of the QR/P and QR/P1 Series, whose rectangular multi-electrode plug in connectors for racks and

panels have been well received in the market. Three different electrode numbers are available: 8, 12 and 20. Wires are connected to the connectors without solder for easier connection and higher reliability.

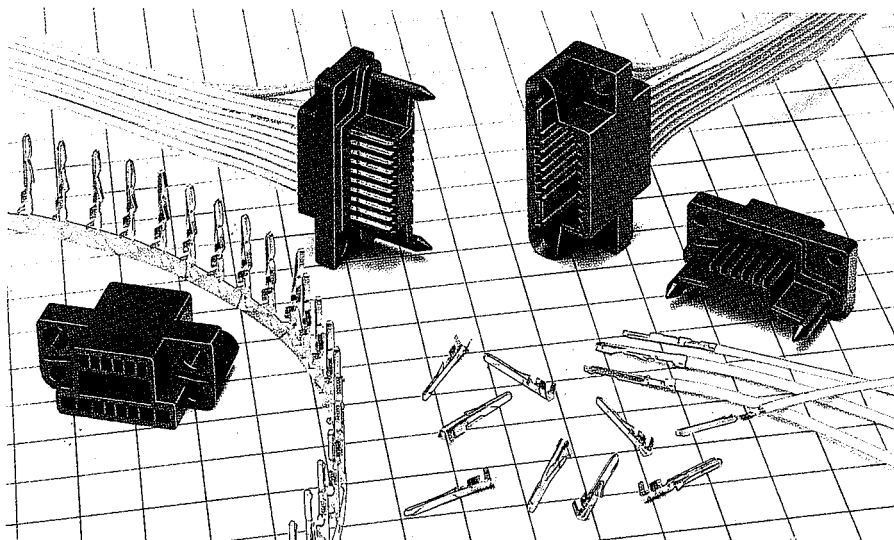

### Features

- (1) The connector of this series is about 20% smaller in length than of the QR/P4 Series with the same number of electrodes.
- (2) Two pairs of electrodes on two sides have a pitch of 5.3 mm at the reinforcement of the housing guide pins, making the connector size smaller and enabling the connector to withstand high voltages. These electrodes therefore can be used for power supply. The terminals for signals have a pitch of 2 mm.
- (3) Wires of AWG # 20 — 28 can be connected with the two pairs of terminals on the two sides, while wires of AWG # 24 — 28 can be connected with the terminals for signals.
- (4) The pins give stable contact pressure because of their point contact with the receptacle blades, and have a larger allowance for the variation of connection length — a characteristic of plug-in connectors.
- (5) The guide pins and the housing body are moulded as one piece to achieve a smaller connector size.
- (6) Since the connectors are mounted on racks or panels with stepped screws, connection and disconnection can be done easily.
- (7) The connectors of this series have passed UL, CSA and TÜV standards.

### Application

PPC, Transmission and reception equipment, Data Communication, Vending Machine, Measuring Instruments, Automatic Equipment, Switchboards, etc.

## Specifications

Main Specifications		
Contact resistance	30mΩ or less at DC1A	
Insulation resistance	1000M Ω or less at DC 500V	
Withstand voltage (for 1 min.)	Power supply	AC 2000V
	Signal unit	AC 500V

Item	Material	Finish
Insulator	Polycarbonate resin UL94V-0	Black
Contact	Phosphor Bronze	Selective Gold plated over Nickel

## Material and Finish

QR/P8 ratings approved by safety standards				
Safety standard		UL,CSA	TÜV	
Operating temperature range		-10~+60°C		
Voltage rating	Power supply	AC 300V	AC 380V	
	Signal unit	AC 30V	AC 30V	
Rated current	AWG # 20	3A	2.5A	
	AWG # 22	3A	2.5A	
	AWG # 24	Power unit	2A	2.5A
		Signal unit	2A	1A
	AWG # 26	1A	1A	
AWG # 28	1A	1A		

## Ordering Information

### ▲ Connector Unit

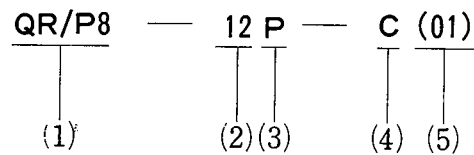

### ▲ Contact

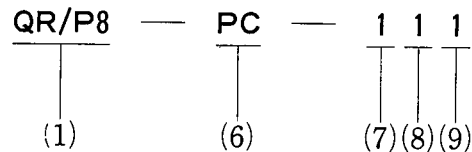

- (1) Series Name
- (2) No. of Pins (8, 12, 20)
- (3) Type of Housing  
P : Plug Housing  
S : Socket Housing
- (4) Type of Termination  
C : Crimping
- (5) UL, CSA Approved Spec.
- (6) Type of Contact  
PC : Pin Contact  
SC : Socket Contact

- (7) Contact Type  
1 : Loose Contact  
2 : Chain Contact
- (8) Applicable Wire  
1 : Thick Wire AWG#20~#24 ... For two contact holes at both ends  
2 : Thin Wire AWG#24~#28
- (9) Finish  
1 : Selective Gold plated over Nickel

# Housing

## Male Housing

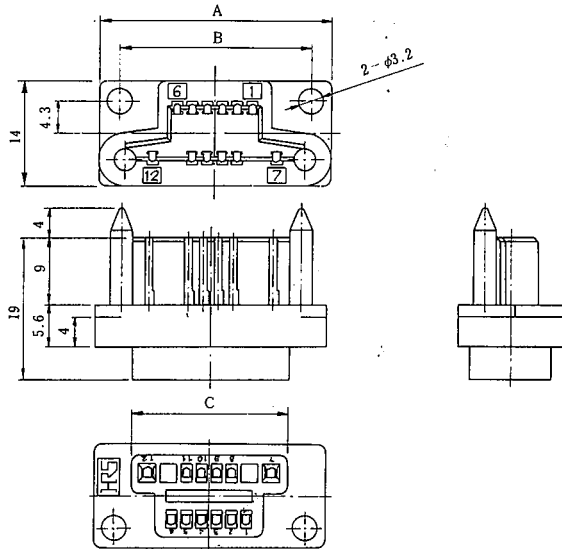
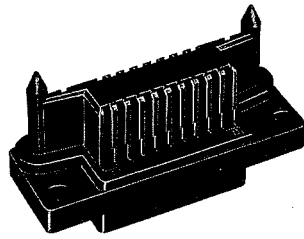

Unit:mm

HRS No.	No. of Pin	Part No.	A	B	C
CL221-0167-3-01	.8	QR/P8-8P-C(01)	27	21.6	17
CL221-0169-9-01	12	QR/P8-12P-C(01)	31	25.6	21
CL221-0171-0-01	20	QR/P8-20P-C(01)	39	33.6	29

Note: Determine the combinations with the panel so that the mating clearance between the P side

## Female Housing

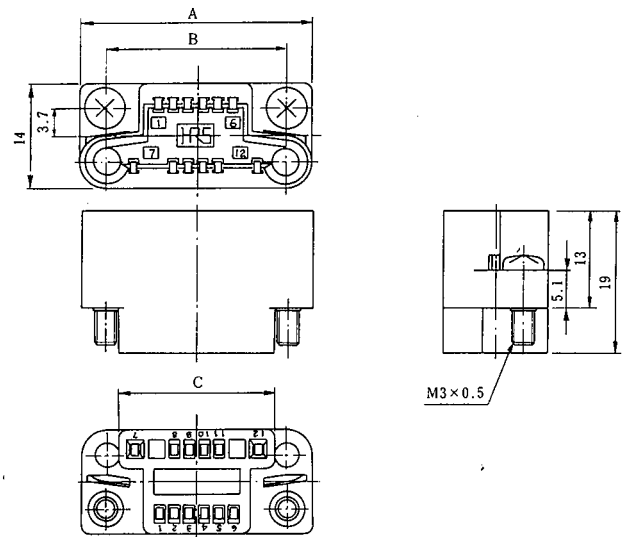
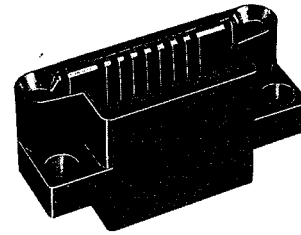

Unit:mm

HRS No.	No. of Pin	Part No.	A	B	C
CL221-0168-6-01	8	QR/P8-8S-C(01)	27	20.4	17
CL221-0170-8-01	12	QR/P8-12S-C(01)	31	24.4	21
CL221-0172-3-01	20	QR/P8-20S-C(01)	39	32.4	29

and S side is 1 mm or less.

# Contact

## Thick Wire (For Two Contact Holes at Male Contact Both Ends)

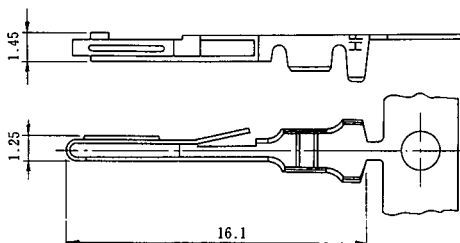

Selective gold plating with nickel under plating

Applicable Wire	HRS No.	Part No.	Type	Packing
AWG #20-24	CL221-0182-7	QR/P8-PC-111	Loose	100pin
	CL221-0175-1	QR/P8-PC-211	Chain	8,000pin

## Thick Wire (For Two Contact Holes at Female Contact Both Ends)

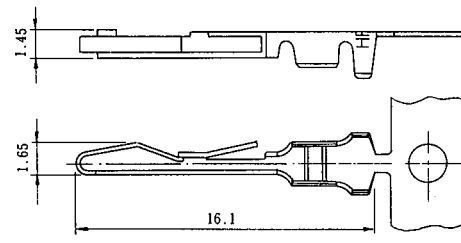

Applicable Wire	HRS No.	Part No.	Type	Packing
AWG #20-24	CL221-0183-0	QR/P8-SC-111	Loose	100pin
	CL221-0173-6	QR/P8-SC-211	Chain	8,000pin

# Contact

## Thin Wire Male Contact

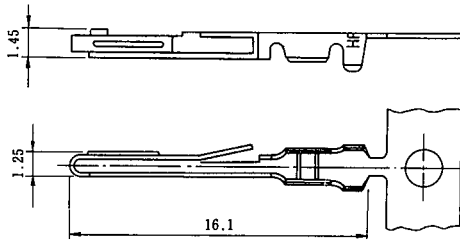

Partly gold plated over nickel plating

Applicable Wire	HRS No.	Part No.	Type	Packing
AWG #24-28	CL221-0184-2	CR/P8-PC-121	Loose	100pin
	CL221-0176-4	CR/P8-PC-221	Chain	8,000pin

## Thin Wire Female Contact

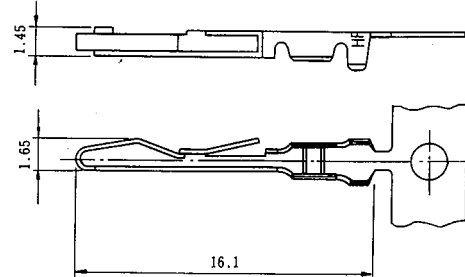

Partly gold plated over nickel plating

Applicable Wire	HRS No.	Part No.	Type	Packing
AWG #24-28	CL221-0185-5	CR/P8-SC-121	Loose	100pin
	CL221-0174-9	CR/P8-SC-221	Chain	8,000pin

# Panel Cutout

## QR/P8-\*P-C

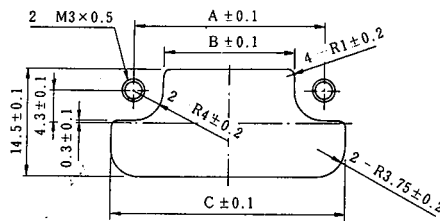

Mounting from rear surface of panel

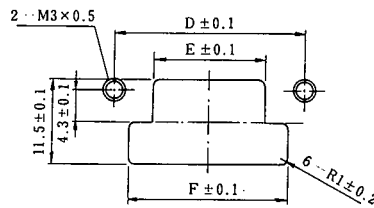

Mounting from front surface of panel

No. of pins		8 pin	12 pin	20 pin
Rear Mounting	A	21.6	25.6	33.6
	B	13.6	17.6	25.6
	C	27.5	31.5	39.5
Front Mounting	D	21.6	25.6	33.6
	E	11.1	15.1	23.1
	F	17.5	21.5	29.5

## QR/P8-\*S-C

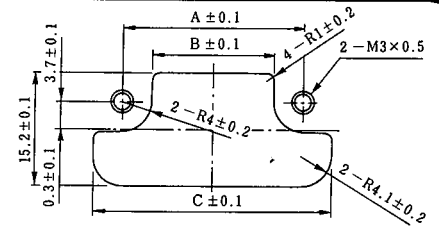

Mounting from rear surface of panel

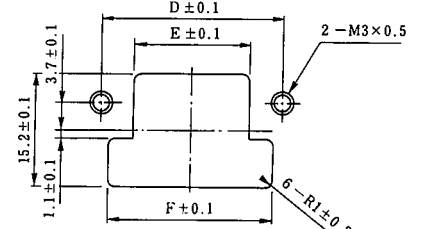

Mounting from front surface of panel

No. of pins		8 pin	12 pin	20 pin
Rear Mounting	A	20.4	24.4	32.4
	B	12.4	16.4	24.4
	C	28.2	32.2	40.2
Front Mounting	D	20.4	24.4	32.4
	E	11.6	15.6	23.6
	F	18.2	22.2	30.2

# Tooling



Hand Crimp Tool

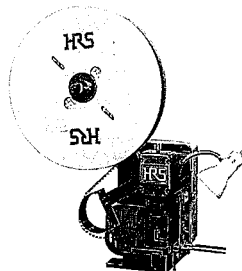

Auto Crimp Machine CM-105  
CL901-0005-4

Kind	HRS No.	Part No.	Applicable Contact
Hand Crimp Tool	CL250-0030-4	TC-QR/P8-111	QR/P8-PC-111
			QR/P8-SC-111
	CL250-0031-7	TC-QR/P8-121	QR/P8-PC-121
			QR/P8-SC-121
Auto Crimp Machine Applicator	CL901-2533-3	AP105-QR/P8-1	QR/P8-PC-211
			QR/P8-SC-211
	CL901-2534-6	AP105-QR/P8-2	QR/P8-PC-221
			QR/P8-SC-221
Contact Extractor	CL250-0033-2	TC-QR/P8-21	

Copyright © Each Manufacturing Company.

All Datasheets cannot be modified without permission.

This datasheet has been download from :

[www.AllDataSheet.com](http://www.AllDataSheet.com)

100% Free DataSheet Search Site.

Free Download.

No Register.

Fast Search System.

[www.AllDataSheet.com](http://www.AllDataSheet.com)