



HIGH VOLTAGE POWER OPERATIONAL AMPLIFIER

PA98

HTTP://WWW.APEXMICROTECH.COM (800) 546-APEX (800) 546-2739

FEATURES

- HIGH VOLTAGE — 450V ($\pm 225V$)
- HIGH SLEW RATE — $1000V/\mu S$
- HIGH OUTPUT CURRENT — 200mA

APPLICATIONS

- HIGH VOLTAGE INSTRUMENTATION
- PIEZO TRANSDUCER EXCITATION
- PROGRAMMABLE POWER SUPPLIES UP TO 430V
- ELECTROSTATIC TRANSDUCERS & DEFLECTION

DESCRIPTION

The PA98 is a high voltage, high power bandwidth MOSFET operational amplifier designed for output currents up to 200mA. Output voltages can swing up to $\pm 215V$ with a dual supply and up to +440 volts with a single supply. The safe operating area (SOA) has no second breakdown limitations and can be observed with all types of loads by choosing an appropriate current limiting resistor. High accuracy is achieved with a cascode input circuit configuration. All internal biasing is referenced to a bootstrapped zener-MOSFET current source. As a result, the PA98 features an unprecedented supply range and excellent supply rejection. The MOSFET output stage is biased on for linear operation. External compensation provides user flexibility.

This hybrid circuit utilizes thick film (cermet) resistors, ceramic capacitors and silicon semiconductor chips to maximize reliability, minimize size and give top performance. Ultrasonically bonded aluminum wires provide reliable interconnections at all operating temperatures.

EQUIVALENT SCHEMATIC

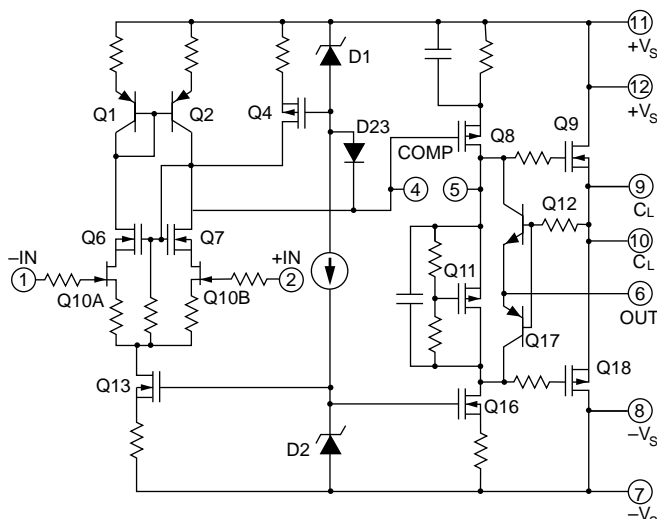

PATENTED

TYPICAL APPLICATION

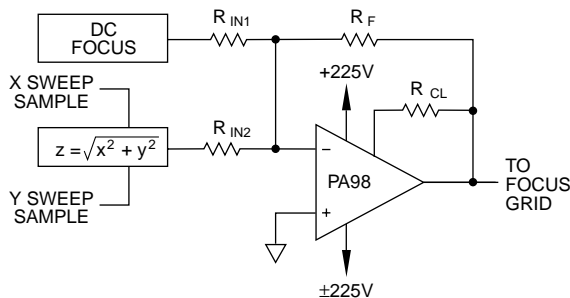

DYNAMIC FOCUSING

Dynamic focusing is the active correction of focusing voltage as a beam traverses the face of a CRT. This is necessary in high resolution flat face monitors since the distance between cathode and screen varies as the beam moves from the center of the screen to the edges. PA98 lends itself well to this function since it can be connected as a summing amplifier with inputs from the nominal focus potential and the dynamic correction. The nominal might be derived from a potentiometer, or perhaps automatic focusing circuitry might be used to generate this potential. The dynamic correction is generated from the sweep voltages by calculating the distance of the beam from the center of the display.

EXTERNAL CONNECTIONS

PACKAGE: SIP03

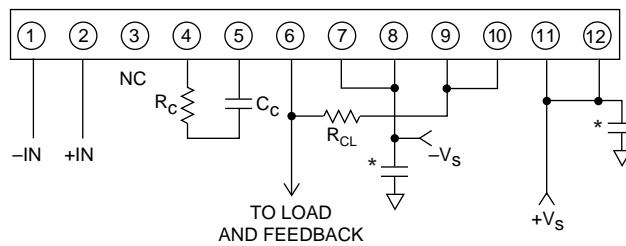

PHASE COMPENSATION

Gain	C _C	R _C
1	68pF	100Ω
20	10pF	330Ω
100	3.3pF	0Ω

C_C RATED FOR FULL SUPPLY VOLTAGE

ABSOLUTE MAXIMUM RATINGS

SUPPLY VOLTAGE, +V _S to -V _S	450V
OUTPUT CURRENT, continuous within SOA	200mA
POWER DISSIPATION, continuous @ T _C = 25°C ²	30W
INPUT VOLTAGE, differential	±25V
INPUT VOLTAGE, common mode	±V _S
TEMPERATURE, pin solder - 10s max	220°C
TEMPERATURE, junction ²	150°C
TEMPERATURE, storage	-65 to +150°C
OPERATING TEMPERATURE RANGE, case	-55 to +125°C

SPECIFICATIONS

PARAMETER	TEST CONDITIONS ¹	MIN	TYP	MAX	UNITS
INPUT					
OFFSET VOLTAGE, initial			.5	2	mV
OFFSET VOLTAGE, vs. temperature	Full temperature range		10	30	μV/°C
OFFSET VOLTAGE, vs. supply			3	10	μV/V
OFFSET VOLTAGE, vs. time			75		μV/kh
BIAS CURRENT, initial ³			5	50	pA
BIAS CURRENT, vs. supply			.01		pA/V
OFFSET CURRENT, initial ³			10	100	pA
INPUT IMPEDANCE, DC			10 ¹¹		Ω
INPUT CAPACITANCE			4		pF
COMMON MODE VOLTAGE RANGE ⁴		±V _S -12			V
COMMON MODE REJECTION, DC	V _{CM} = ±90V	90	110		dB
NOISE	100kHz BW, R _S = 1KΩ, C _C = 10pf		1		μVrms
GAIN					
OPEN LOOP, @ 15Hz	R _L = 2KΩ, C _C = OPEN	96	111		dB
GAIN BANDWIDTH PRODUCT at 1MHz	R _L = 2KΩ, C _C = 3.3pf		100		MHz
POWER BANDWIDTH	C _C = 10pf		300		kHz
	C _C = 3.3pf		500		kHz
PHASE MARGIN	Full temperature range		60		°
OUTPUT					
VOLTAGE SWING ⁴	I _O = ±200mA	±V _S -10	±V _S -6.5		V
VOLTAGE SWING ⁴	I _O = ±75mA	±V-8.5	±V _S -6.0		V
VOLTAGE SWING ⁴	I _O = ±20mA	±V-8.0	±V _S -5.5		V
CURRENT, continuous	T _C = 85°C	±200			mA
SLEW RATE, A _V = 20	C _C = 10pf		400		V/μs
SLEW RATE, A _V = 100	C _C = OPEN		1000		V/μs
CAPACITIVE LOAD, A _V = +1	Full temperature range	470			pf
SETTLING TIME to .1%	C _C = 10pf, 2V step		1		μs
RESISTANCE, no load	R _{CL} = 0		50		Ω
POWER SUPPLY					
VOLTAGE ⁶	Full temperature range	±15	±150	±225	V
CURRENT, quiescent			21	25	mA
THERMAL					
RESISTANCE, AC, junction to case ⁵	Full temperature range, F > 60Hz			2.5	°C/W
RESISTANCE, DC, junction to case	Full temperature range, F < 60Hz			4.2	°C/W
RESISTANCE, junction to air	Full temperature range		30		C/W
TEMPERATURE RANGE, case	Meets full range specifications	-25		+85	°C

- NOTES: 1. Unless otherwise noted: T_C = 25°C, compensation = C_C = 68pF, R_C = 100Ω. DC input specifications are ± value given. Power supply voltage is typical rating.
2. Long term operation at the maximum junction temperature will result in reduced product life. Derate internal power dissipation to achieve high MTTF. Ratings apply only to output transistors. An additional 10W may be dissipated due to quiescent power.
3. Doubles for every 10°C of temperature increase.
4. +V_S and -V_S denote the positive and negative power supply rail respectively.
5. Rating applies if the output current alternates between both output transistors at a rate faster than 60Hz.
6. Derate max supply rating .625 V/°C below 25°C case. No derating needed above 25°C case.

CAUTION

The PA98 is constructed from MOSFET transistors. ESD handling procedures must be observed.

The internal substrate contains beryllia (BeO). Do not break the seal. If accidentally broken, do not crush, machine, or subject to temperatures in excess of 850°C to avoid generating toxic fumes.

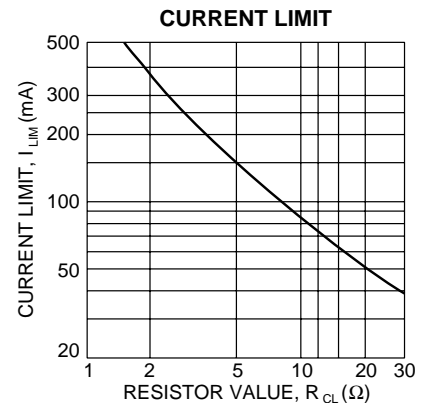
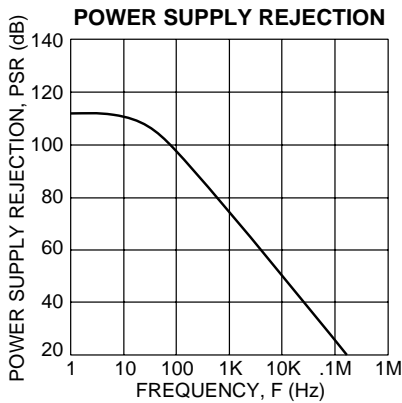
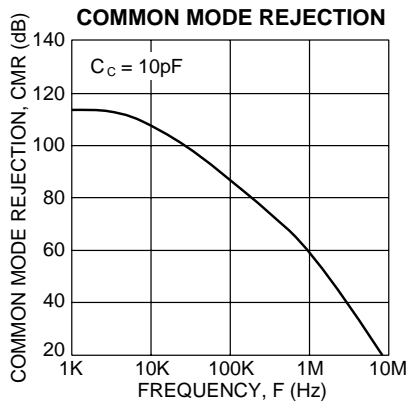
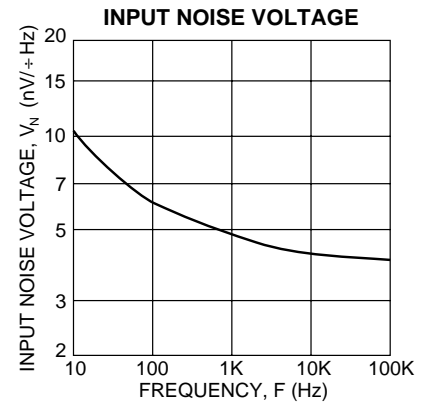
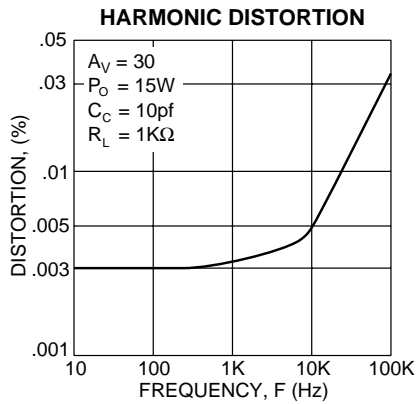
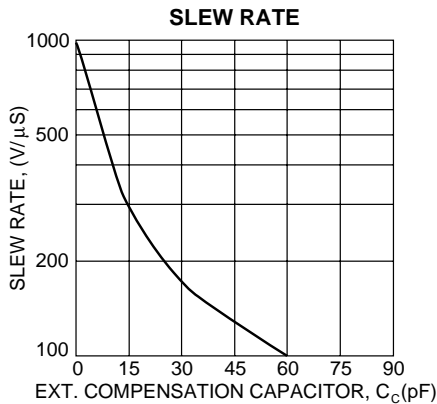
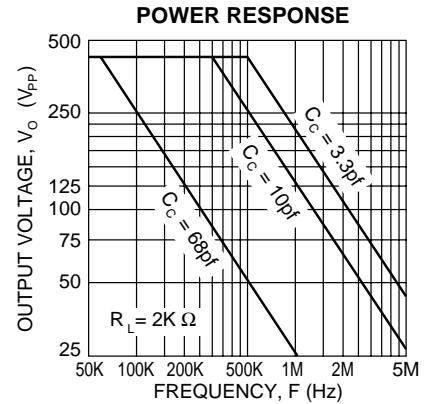
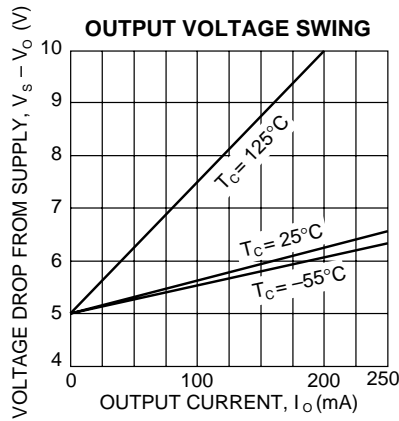
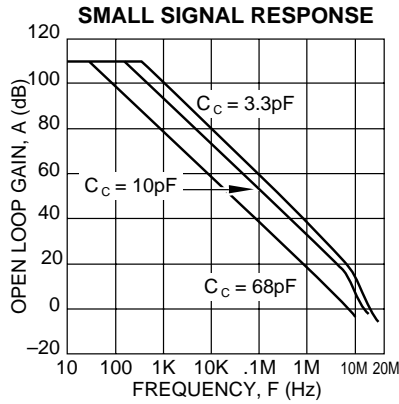
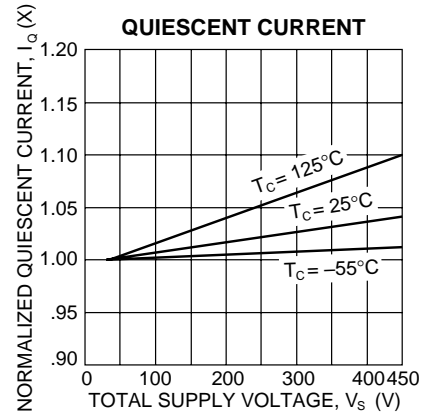
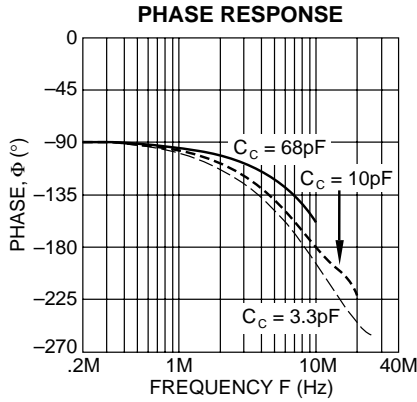
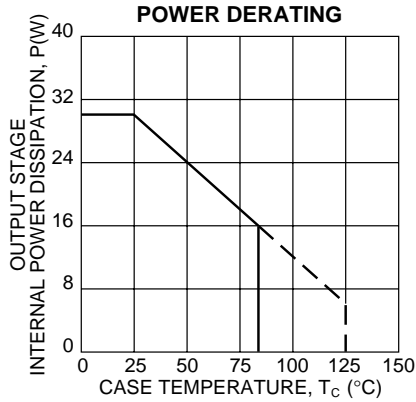

GENERAL

Please read the "General Operating Considerations" section, which covers stability, supplies, heatsinking, mounting, current limit, SOA interpretation, and specification interpretation. Additional information can be found in the application notes. For information on the package outline, heatsinks, and mounting hardware, consult the "Accessory and Package Mechanical Data" section of the handbook.

CURRENT LIMIT

For proper operation, the current limit resistor (R_{CL}) must be connected as shown in the external connection diagram. The minimum value is 1.4 ohm, however for optimum reliability the resistor value should be set as high as possible. The value is calculated as follows; with the maximum practical value of 30 ohms.

$$R_{CL} = \frac{.7}{I_{LIM} - .016}$$

SAFE OPERATING AREA (SOA)

The MOSFET output stage of this power operational amplifier has two distinct limitations:

1. The current handling capability of the MOSFET geometry and the wire bonds.
2. The junction temperature of the output MOSFETs.

NOTE: The output stage is protected against transient flyback. However, for protection against sustained, high energy flyback, external fast-recovery diodes should be used.

SAFE OPERATING CURVES

The safe operating area curves define the maximum additional internal power dissipation the amplifier can tolerate when it produces the necessary output to drive an external load. This is not the same as the absolute maximum internal

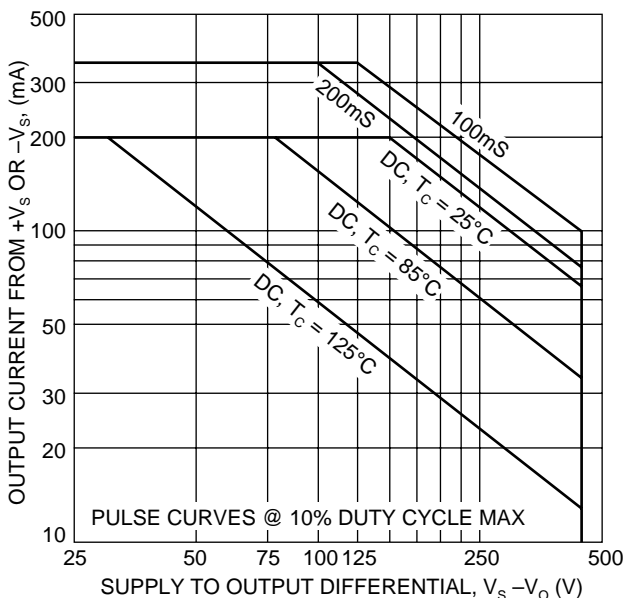

power dissipation listed elsewhere in the specification since the quiescent power dissipation is significant compared to the total.

INPUT PROTECTION

Although the PA98 can withstand differential voltages up to $\pm 25V$, additional external protection is recommended. Since the PA98 is a high speed amplifier, low leakage, low capacitance JFETs connected as diodes are recommended (e.g. 2N4416, Q1-Q4 in Figure 1). The differential input voltage will be clamped to $\pm 1.4V$. This is sufficient overdrive to produce maximum power bandwidth.

POWER SUPPLY PROTECTION

Unidirectional zener diode transient suppressors are recommended as protection on the supply pins. The zeners clamp transients to voltages within the power supply rating and also clamp power supply reversals to ground. Whether the zeners are used or not, the system power supply should be evaluated for transient performance including power-on overshoot and power-off polarity reversals as well as line regulation.

Conditions which can cause open circuits or polarity reversals on either power supply rail should be avoided or protected against. Reversals or opens on the negative supply rail is known to induce input stage failure. Unidirectional transzors prevent this, and it is desirable that they be both electrically and physically as close to the amplifier as possible.

STABILITY

The PA98 is externally compensated and performance can be tailored to the application. Use the graphs of small signal response and power response as a guide. The compensation capacitor C_c must be rated at 500V working voltage. An NPO capacitor is recommended. The compensation network $C_c R_c$ must be mounted closely to the amplifier pins 7 and 8 to avoid spurious oscillation.

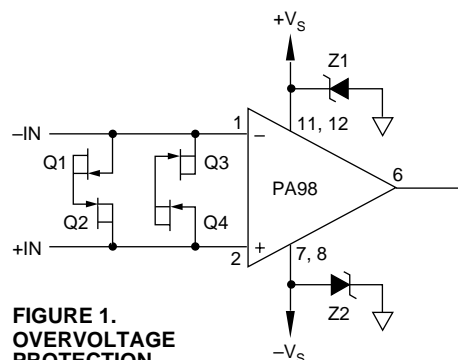

FIGURE 1. OVERVOLTAGE PROTECTION

Copyright © Each Manufacturing Company.

All Datasheets cannot be modified without permission.

This datasheet has been download from :

www.AllDataSheet.com

100% Free DataSheet Search Site.

Free Download.

No Register.

Fast Search System.

www.AllDataSheet.com