

**Rectifier diodes
Schottky barrier**

PBYL3025CT, PBYL3025CTB series

FEATURES

- Low forward volt drop
- Fast switching
- Reverse surge capability
- High thermal cycling performance
- Low thermal resistance

SYMBOL

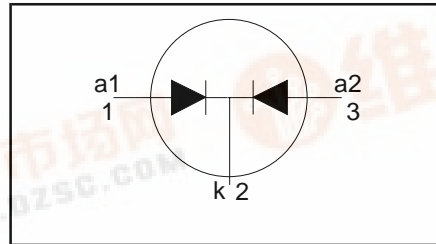

QUICK REFERENCE DATA

$V_R = 20\text{ V} / 25\text{ V}$
$I_{O(AV)} = 30\text{ A}$
$V_F \leq 0.43\text{ V}$

GENERAL DESCRIPTION

Dual schottky rectifier diodes intended for use as output rectifiers in low voltage, high frequency switched mode power supplies.

The PBYL3025CT series is supplied in the SOT78 (TO220AB) conventional leaded package.
The PBYL3025CTB series is supplied in the SOT404 surface mounting package.

PINNING

PIN	DESCRIPTION
1	gate
2	drain ¹
3	source
tab	drain

SOT78 (TO220AB)

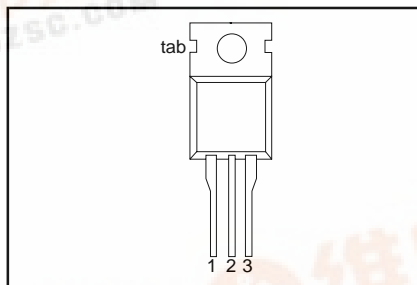

SOT404

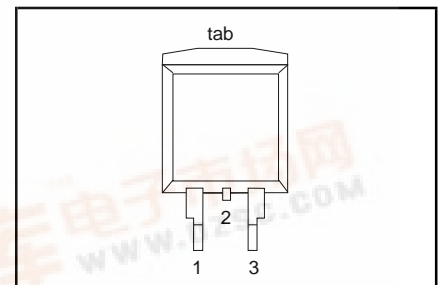

LIMITING VALUES

Limiting values in accordance with the Absolute Maximum System (IEC 134)

SYMBOL	PARAMETER	CONDITIONS	MIN.	MAX.		UNIT
				20CT 20CTB	25CT 25CTB	
V_{RRM}	Peak repetitive reverse voltage	$T_{mb} \leq 120\text{ }^\circ\text{C}$	-	20	25	V
V_{RWM}	Working peak reverse voltage		-	20	25	V
V_R	Continuous reverse voltage		-	20	25	V
$I_{O(AV)}$	Average rectified output current (both diodes conducting)	square wave; $\delta = 0.5$; $T_{mb} \leq 123\text{ }^\circ\text{C}$	-	30		A
I_{FRM}	Repetitive peak forward current per diode	square wave; $\delta = 0.5$; $T_{mb} \leq 123\text{ }^\circ\text{C}$	-	30		A
I_{FSM}	Non-repetitive peak forward current per diode	$t = 10\text{ ms}$	-	135		A
		$t = 8.3\text{ ms}$	-	150		A
I_{RRM}	Peak repetitive reverse surge current per diode	sinusoidal; $T_j = 125\text{ }^\circ\text{C}$ prior to surge; with reapplied $V_{RRM(max)}$ pulse width and repetition rate limited by T_{jmax}	-	1		A
T_j	Operating junction temperature		-	150		$^\circ\text{C}$
	Storage temperature		-65	175		$^\circ\text{C}$

1. It is not possible to make connection to pin 2 of the SOT404 package.



Rectifier diodes
Schottky barrier

PBYL3025CT, PBYL3025CTB series

THERMAL RESISTANCES

SYMBOL	PARAMETER	CONDITIONS	MIN.	TYP.	MAX.	UNIT
$R_{th\ j-mb}$	Thermal resistance junction to mounting base	per diode	-	-	2	K/W
		both diodes	-	-	1.5	K/W
$R_{th\ j-a}$	Thermal resistance junction to ambient	SOT78 package, in free air	-	60	-	K/W
		SOT404 package, pcb mounted, minimum footprint, FR4 board	-	50	-	K/W

ELECTRICAL CHARACTERISTICS

All characteristics are per diode at $T_j = 25\text{ }^\circ\text{C}$ unless otherwise specified

SYMBOL	PARAMETER	CONDITIONS	MIN.	TYP.	MAX.	UNIT
V_F	Forward voltage	$I_F = 15\text{ A}; T_j = 150\text{ }^\circ\text{C}$	-	0.35	0.43	V
		$I_F = 15\text{ A}; T_j = 125\text{ }^\circ\text{C}$	-	0.38	0.46	V
		$I_F = 30\text{ A}; T_j = 125\text{ }^\circ\text{C}$	-	0.52	0.6	V
		$I_F = 30\text{ A}$	-	0.6	0.67	V
I_R	Reverse current	$V_R = V_{RWM}$	-	1	5	mA
		$V_R = V_{RWM}; T_j = 100\text{ }^\circ\text{C}$	-	22	40	mA
C_d	Junction capacitance	$V_R = 5\text{ V}; f = 1\text{ MHz}; T_j = 25\text{ }^\circ\text{C to } 125\text{ }^\circ\text{C}$	-	700	-	pF

Rectifier diodes
Schottky barrier

PBYL3025CT, PBYL3025CTB series

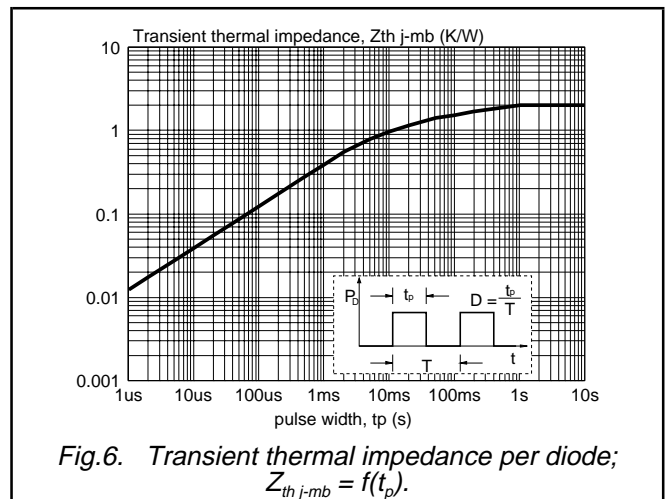
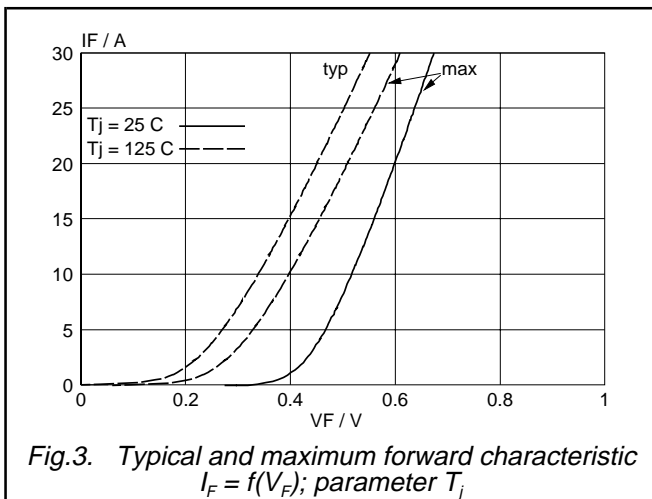
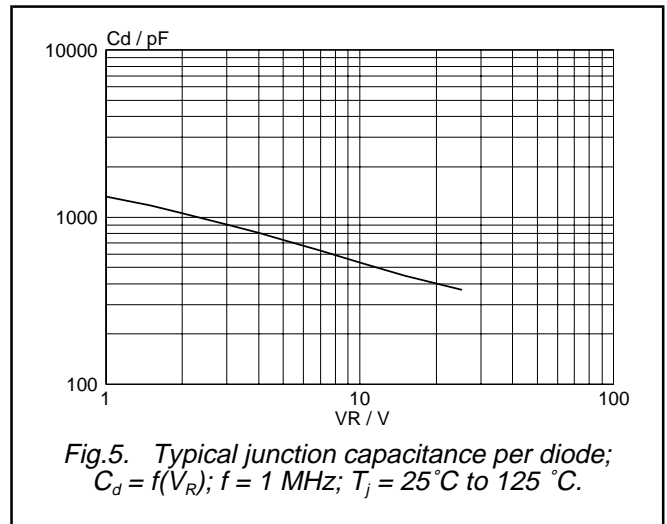
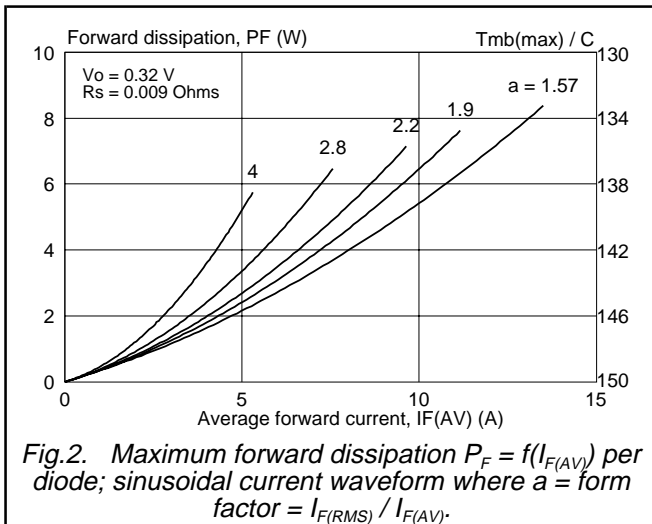
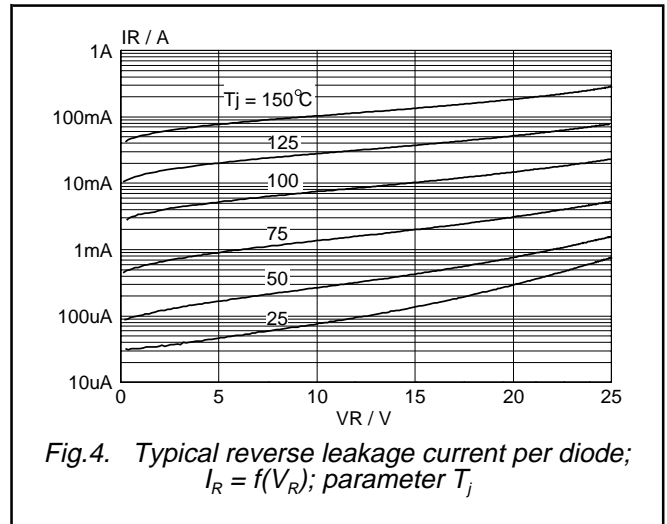
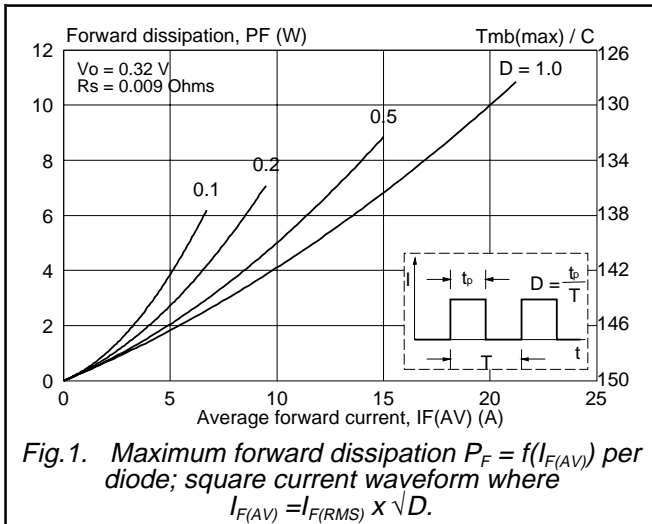

Rectifier diodes
Schottky barrier

PBYL3025CT, PBYL3025CTB series

MECHANICAL DATA

Dimensions in mm

Net Mass: 1.4 g

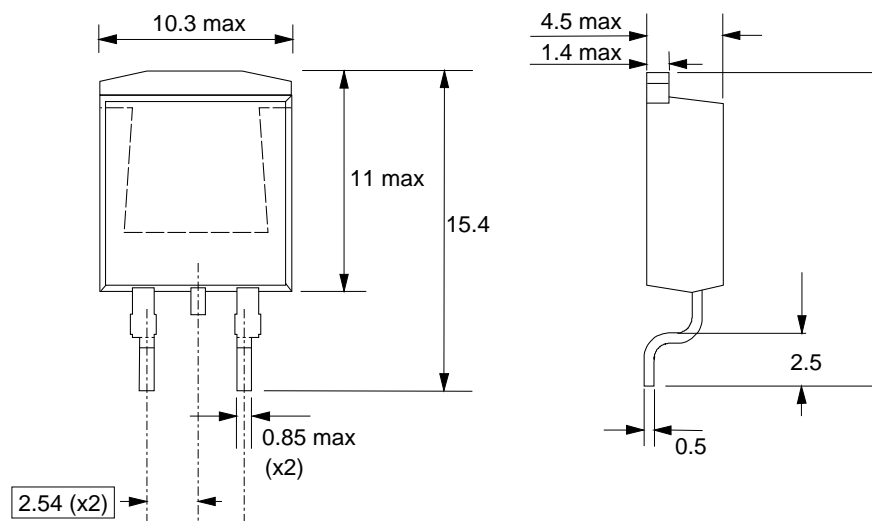

Fig.8. SOT404 : centre pin connected to mounting base.

MOUNTING INSTRUCTIONS

Dimensions in mm

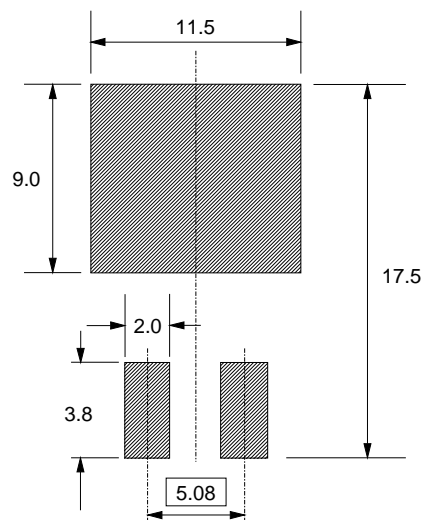

Fig.9. SOT404 : soldering pattern for surface mounting.

Notes

- 1. Epoxy meets UL94 V0 at 1/8".

Rectifier diodes
Schottky barrier

PBYL3025CT, PBYL3025CTB series

DEFINITIONS

Data sheet status	
Objective specification	This data sheet contains target or goal specifications for product development.
Preliminary specification	This data sheet contains preliminary data; supplementary data may be published later.
Product specification	This data sheet contains final product specifications.
Limiting values	
Limiting values are given in accordance with the Absolute Maximum Rating System (IEC 134). Stress above one or more of the limiting values may cause permanent damage to the device. These are stress ratings only and operation of the device at these or at any other conditions above those given in the Characteristics sections of this specification is not implied. Exposure to limiting values for extended periods may affect device reliability.	
Application information	
Where application information is given, it is advisory and does not form part of the specification.	
© Philips Electronics N.V. 1998	
All rights are reserved. Reproduction in whole or in part is prohibited without the prior written consent of the copyright owner.	
The information presented in this document does not form part of any quotation or contract, it is believed to be accurate and reliable and may be changed without notice. No liability will be accepted by the publisher for any consequence of its use. Publication thereof does not convey nor imply any license under patent or other industrial or intellectual property rights.	

LIFE SUPPORT APPLICATIONS

These products are not designed for use in life support appliances, devices or systems where malfunction of these products can be reasonably expected to result in personal injury. Philips customers using or selling these products for use in such applications do so at their own risk and agree to fully indemnify Philips for any damages resulting from such improper use or sale.