

**Rectifier diodes
Schottky barrier**

PBYR30100WT series

FEATURES

- Low forward volt drop
- Fast switching
- Reverse surge capability
- High thermal cycling performance
- Low thermal resistance

SYMBOL

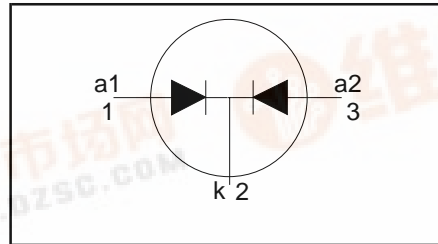

QUICK REFERENCE DATA

$V_R = 60\text{ V} / 80\text{ V} / 100\text{ V}$
$I_{O(AV)} = 30\text{ A}$
$V_F \leq 0.7\text{ V}$

GENERAL DESCRIPTION

Schottky rectifier diodes in a plastic envelope. Intended for use as output rectifiers in low voltage, high frequency switched mode power supplies.

The PBYR30100WT series is supplied in the conventional leaded SOT429 (TO247) package.

PINNING

PIN	DESCRIPTION
1	anode 1
2	cathode
3	anode 2
mounting base	cathode

SOT429 (TO247)

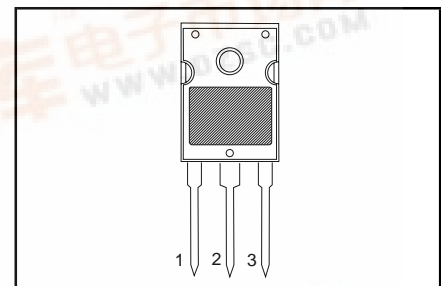

LIMITING VALUES

Limiting values in accordance with the Absolute Maximum System (IEC 134)

SYMBOL	PARAMETER	CONDITIONS	MIN.	MAX.			UNIT
				60WT	80WT	100WT	
V_{RRM}	Peak repetitive reverse voltage	PBYR30	-	60	80	100	V
V_{RWM}	Working peak reverse voltage		-	60	80	100	V
V_R	Continuous reverse voltage	$T_{mb} \leq 139\text{ }^\circ\text{C}$	-	60	80	100	V
$I_{O(AV)}$	Average rectified output current (both diodes conducting)	square wave; $\delta = 0.5$; $T_{mb} \leq 124\text{ }^\circ\text{C}$	-	30			A
I_{FRM}	Repetitive peak forward current per diode	square wave; $\delta = 0.5$; $T_{mb} \leq 124\text{ }^\circ\text{C}$	-	30			A
I_{FSM}	Non-repetitive peak forward current per diode	$t = 10\text{ ms}$	-	180			A
		$t = 8.3\text{ ms}$	-	200			A
I_{RRM}	Peak repetitive reverse surge current per diode	sinusoidal; $T_j = 125\text{ }^\circ\text{C}$ prior to surge; with reapplied $V_{RRM(max)}$ pulse width and repetition rate limited by T_{jmax}	-	1			A
T_j	Operating junction temperature		-	150			$^\circ\text{C}$
T_{stg}	Storage temperature		- 65	175			$^\circ\text{C}$

THERMAL RESISTANCES

SYMBOL	PARAMETER	CONDITIONS	MIN.	TYP.	MAX.	UNIT
$R_{th\ j-mb}$	Thermal resistance junction to mounting base	per diode	-	-	1.4	K/W
$R_{th\ j-a}$	Thermal resistance junction to ambient	both diodes in free air	-	-	1	K/W
			-	45	-	K/W



Rectifier diodes
Schottky barrier

PBYR30100WT series

ELECTRICAL CHARACTERISTICS

characteristics are per diode at $T_j = 25\text{ }^\circ\text{C}$ unless otherwise specified

SYMBOL	PARAMETER	CONDITIONS	MIN.	TYP.	MAX.	UNIT
V_F	Forward voltage	$I_F = 15\text{ A}; T_j = 125\text{ }^\circ\text{C}$	-	0.61	0.7	V
		$I_F = 30\text{ A}; T_j = 125\text{ }^\circ\text{C}$	-	0.74	0.85	V
		$I_F = 15\text{ A}$	-	0.77	0.85	V
I_R	Reverse current	$V_R = V_{RWM}$	-	5	150	μA
		$V_R = V_{RWM}; T_j = 125\text{ }^\circ\text{C}$	-	5	15	mA
C_d	Junction capacitance	$V_R = 5\text{ V}; f = 1\text{ MHz}; T_j = 25\text{ }^\circ\text{C to } 125\text{ }^\circ\text{C}$	-	600	-	pF

Rectifier diodes
Schottky barrier

PBYR30100WT series

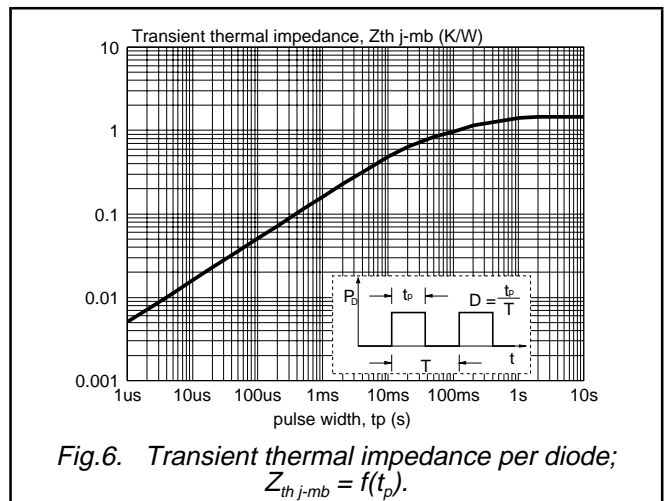
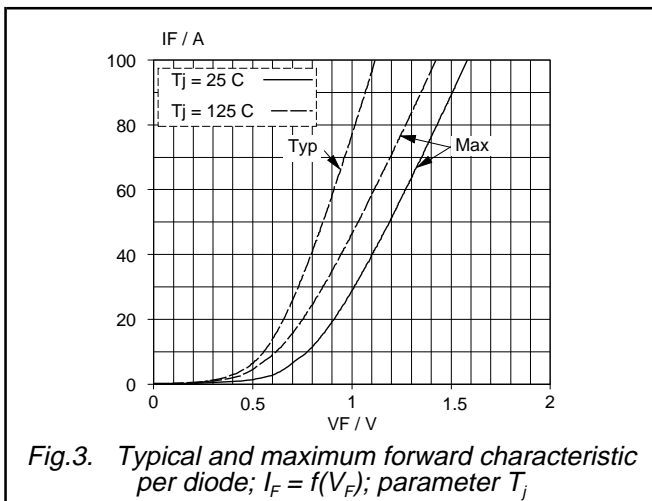
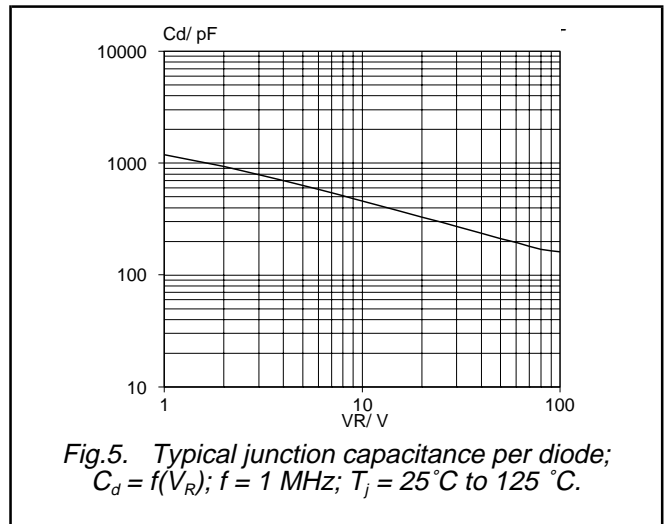
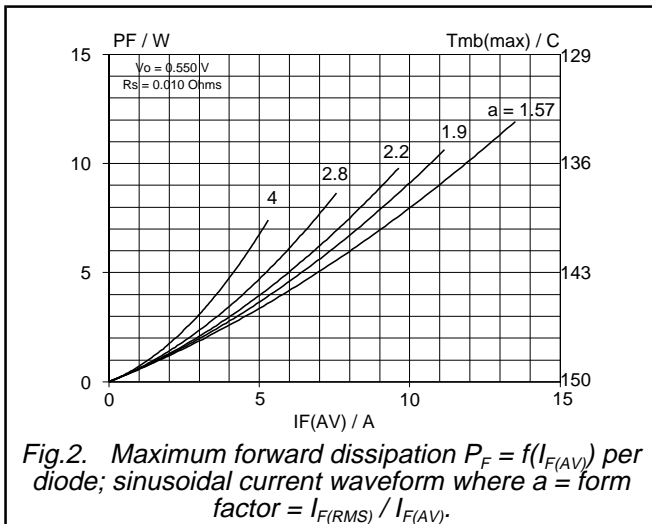
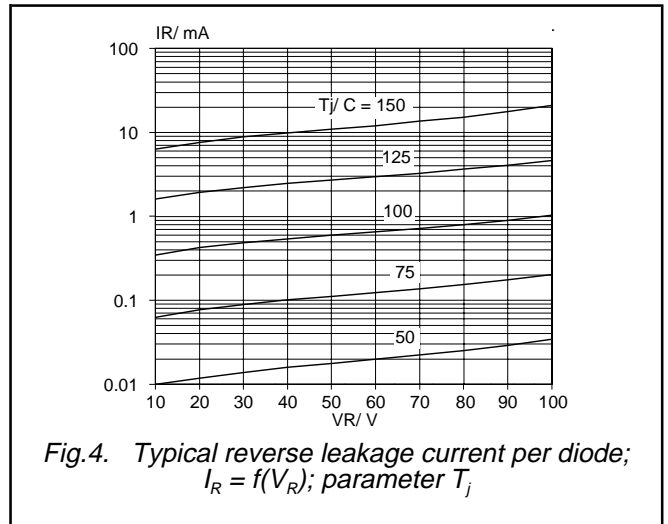
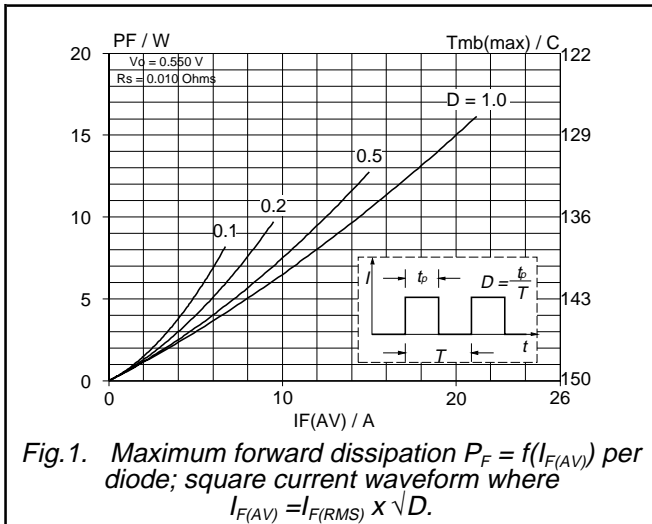

Rectifier diodes
Schottky barrier

PBYR30100WT series

MECHANICAL DATA

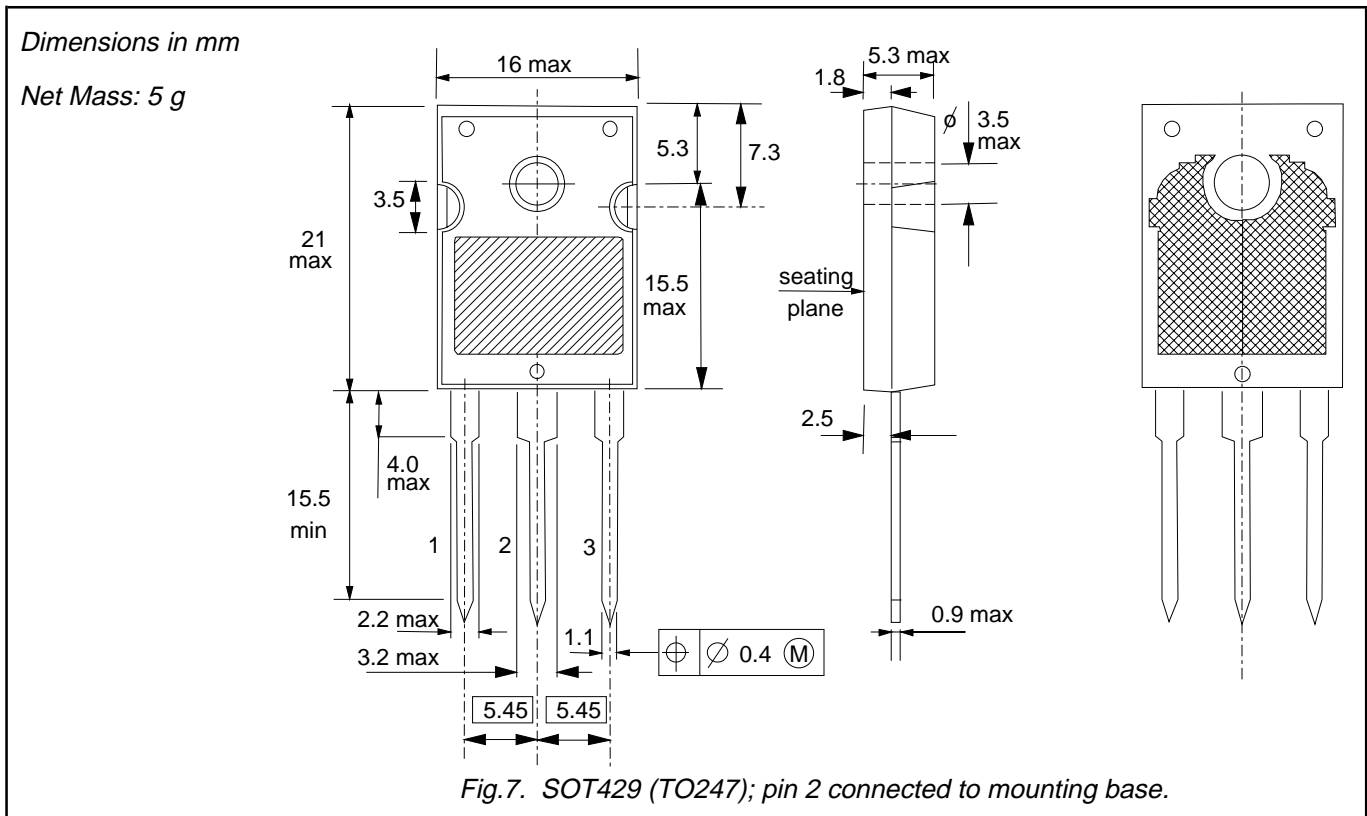

Notes

1. Refer to mounting instructions for SOT429 envelope.
2. Epoxy meets UL94 V0 at 1/8".

Rectifier diodes
Schottky barrier

PBYR30100WT series

DEFINITIONS

Data sheet status	
Objective specification	This data sheet contains target or goal specifications for product development.
Preliminary specification	This data sheet contains preliminary data; supplementary data may be published later.
Product specification	This data sheet contains final product specifications.
Limiting values	
Limiting values are given in accordance with the Absolute Maximum Rating System (IEC 134). Stress above one or more of the limiting values may cause permanent damage to the device. These are stress ratings only and operation of the device at these or at any other conditions above those given in the Characteristics sections of this specification is not implied. Exposure to limiting values for extended periods may affect device reliability.	
Application information	
Where application information is given, it is advisory and does not form part of the specification.	
© Philips Electronics N.V. 1998	
All rights are reserved. Reproduction in whole or in part is prohibited without the prior written consent of the copyright owner.	
The information presented in this document does not form part of any quotation or contract, it is believed to be accurate and reliable and may be changed without notice. No liability will be accepted by the publisher for any consequence of its use. Publication thereof does not convey nor imply any license under patent or other industrial or intellectual property rights.	

LIFE SUPPORT APPLICATIONS

These products are not designed for use in life support appliances, devices or systems where malfunction of these products can be reasonably expected to result in personal injury. Philips customers using or selling these products for use in such applications do so at their own risk and agree to fully indemnify Philips for any damages resulting from such improper use or sale.