

PC904

Built-in Voltage Detection Circuit Type Photocoupler

※ Lead forming type (I type) and taping reel type (P type) are also available. (**PC904I/PC904P**)

■ Features

1. Built-in voltage detection circuit
2. High isolation voltage between input and output ($V_{iso} : 5\,000V_{rms}$)
3. Standard 8-pin dual-in-line package
4. Recognized by UL, file No. E64380

■ Applications

1. Switching power supplies

■ Outline Dimensions

(Unit : mm)

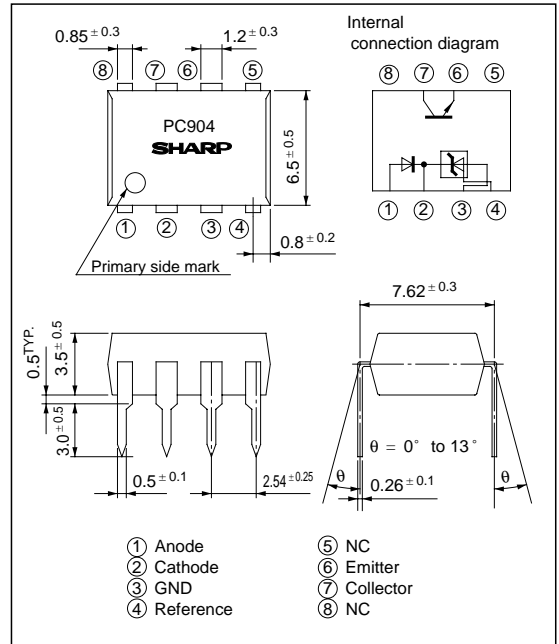

■ Absolute Maximum Ratings

($T_a = 25^\circ C$)

	Parameter	Symbol	Rating	Unit
Input	Anode current	I_A	50	mA
	Anode voltage	V_A	30	V
	Reference input current	I_{REF}	10	mA
	Power dissipation	P	250	mW
Output	Collector-emitter voltage	V_{CEO}	35	V
	Emitter-collector voltage	V_{ECO}	6	V
	Collector current	I_C	50	mA
	Collector power dissipation	P_C	150	mW
	Total power dissipation	P_{tot}	350	mW
	*1 Isolation voltage	V_{iso}	5 000	V_{rms}
	Operating temperature	T_{opr}	- 25 to + 85	$^\circ C$
	Storage temperature	T_{stg}	- 40 to + 125	$^\circ C$
	*2 Soldering temperature	T_{sol}	260	$^\circ C$

*1 40 to 60%RH AC for 1 minute

*2 For 10 seconds

Electro-optical Characteristics

(Ta = 25°C)

Parameter		Symbol	Conditions	MIN.	TYP.	MAX.	Unit	Fig.
Input	Reference voltage	V_{REF}	$V_K = V_{REF}, I_A = 10\text{mA}$	2.40	2.495	2.60	V	1
	*3 Temperature change in reference voltage	$V_{REF(\text{dev})}$	$V_K = V_{REF}, I_A = 10\text{mA}, T_a = -25\text{ to } +85^\circ\text{C}$	-	8	40	mV	1
	Voltage variation ratio in reference voltage	$\Delta V_{REF}/\Delta V_A$	$I_A = 10\text{mA}, \Delta V_A = 30\text{V} - V_{REF}$	-	-1.4	-5	mV/V	2
	Reference input current	I_{REF}	$I_A = 10\text{mA}, R_3 = 10\text{k}\Omega$	-	2	10	μA	3
	*4 Temperature change in reference input current	$I_{REF(\text{dev})}$	$I_A = 10\text{mA}, R_3 = 10\text{k}\Omega, T_a = -25\text{ to } +85^\circ\text{C}$	-	0.4	3	μA	3
	Minimum drive current	I_{MIN}	$V_K = V_{REF}$	-	1	2	mA	1
	OFF-state anode current	I_{OFF}	$V_A = 30\text{V}, V_{REF} = \text{GND}$	-	0.1	2	μA	4
Output	Anode-cathode forward voltage	V_F	$V_K = V_{REF}, I_A = 10\text{mA}$	-	1.2	1.4	V	1
	Collector dark current	I_{CEO}	$V_{CE} = 35\text{V}$	-	1×10^{-9}	1×10^{-7}	A	5
	*5 Current transfer ratio	CTR	$V_K = V_{REF}, I_A = 5\text{mA}, V_{CE} = 5\text{V}$	50	-	600	%	6
Transfer characteristics	Collector-emitter saturation voltage	$V_{CE(\text{sat})}$	$V_K = V_{REF}, I_A = 10\text{mA}, I_C = 1\text{mA}$	-	0.1	0.2	V	6
	Isolation resistance	R_{ISO}	40 to 60% RH, DC500V	5×10^{10}	1×10^{11}	-	Ω	-
	Floating capacitance	C_f	$V = 0, f = 1\text{kHz}$	-	0.6	1.0	pF	-

*3 $V_{REF(\text{dev})} = V_{REF(\text{MAX.})} - V_{REF(\text{MIN.})}$ *4 $I_{REF(\text{dev})} = I_{REF(\text{MAX.})} - I_{REF(\text{MIN.})}$ *5 $\text{CTR} = I_C / I_A \times 100 (\%)$

Classification table of current transfer ratio is shown below.(4 models)

Model No.	Rank mark	CTR (%)
PC904A	A	50 to 150
PC904B	B	100 to 300
PC904C	C	250 to 600
PC904	A, B or C	50 to 600

Test Circuit

Fig. 1

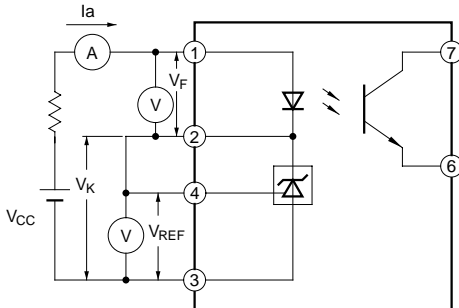

Fig. 2

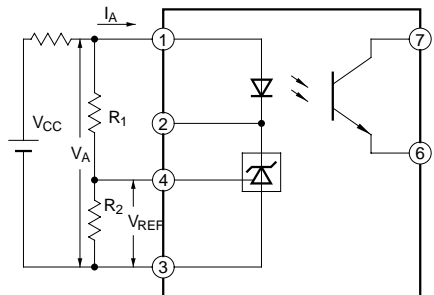

Fig. 3

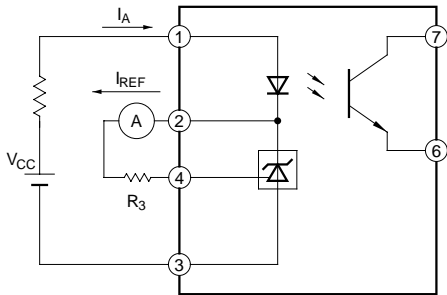

Fig. 4

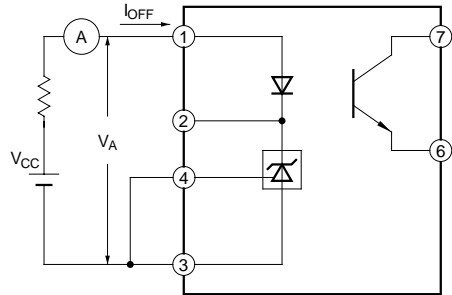

Fig. 5

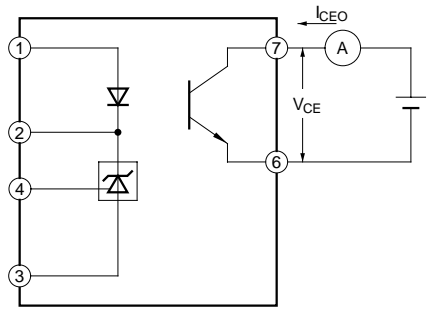

Fig. 6

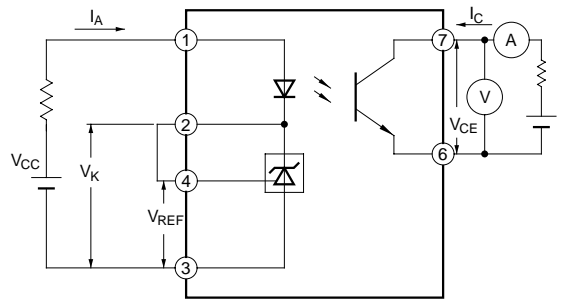

Fig. 7 Anode Current vs. Ambient Temperature

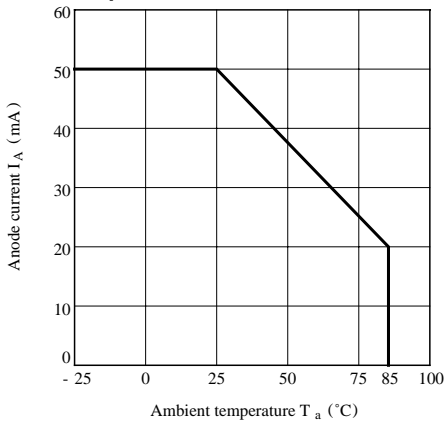

Fig. 8 Input Power Dissipation vs. Ambient Temperature

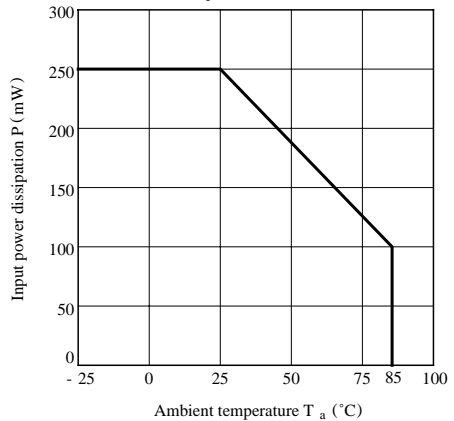

Fig. 9 Collector Power Dissipation vs. Ambient Temperature

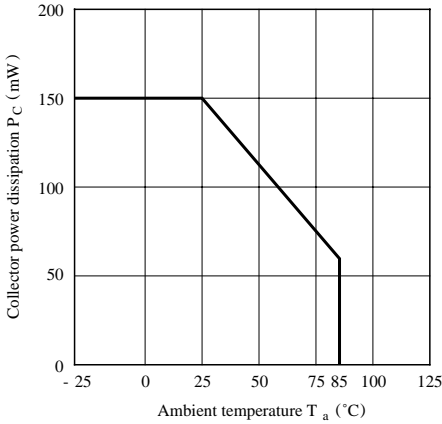

Fig.10 Power Dissipation vs. Ambient Temperature

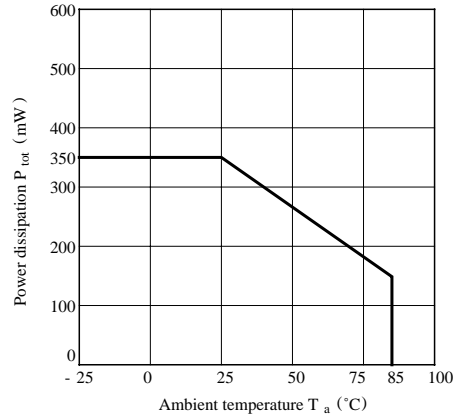

Fig.11 Relative Current Transfer Ratio vs. Ambient Temperature

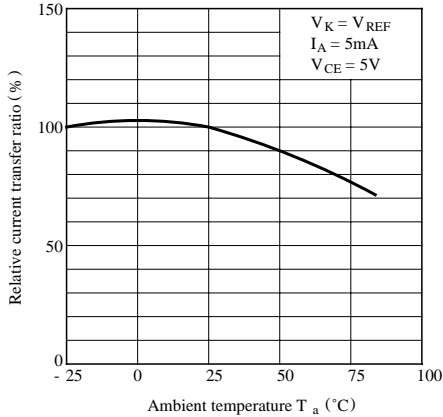

Fig.12 Collector Dark Current vs. Ambient Temperature

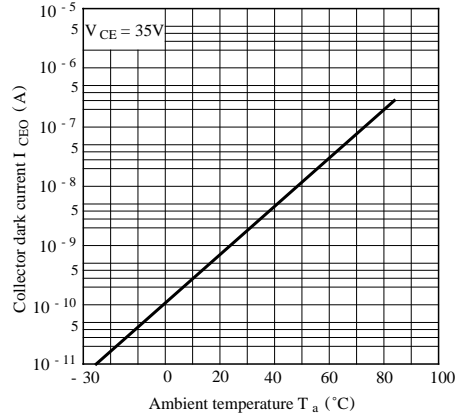

Fig.13-a Anode Current vs. Reference Voltage

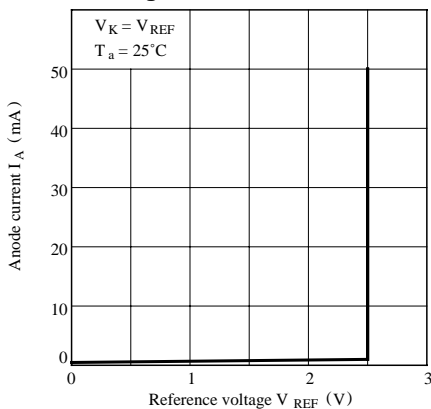

Fig.13-b Anode Current vs. Reference Voltage

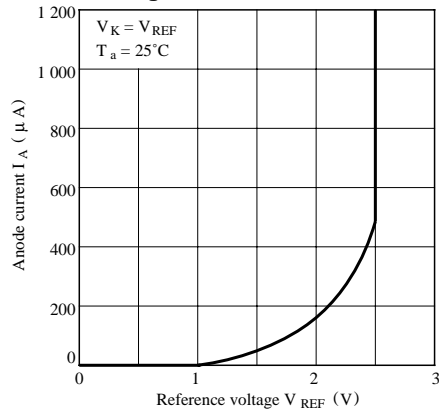

Fig.14 OFF-state Anode Current vs. Ambient Temperature

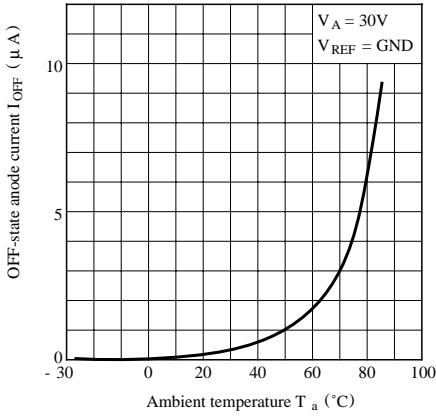

Fig.15 Reference Voltage vs. Ambient Temperature

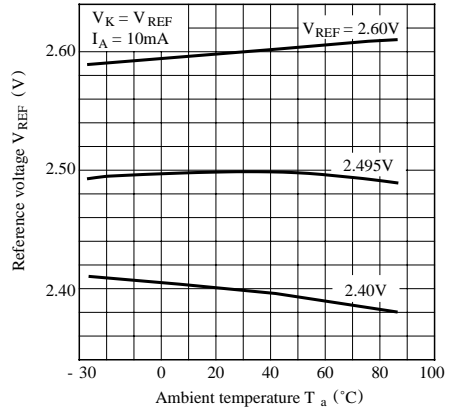

Fig.16 Reference Input Current vs. Ambient Temperature

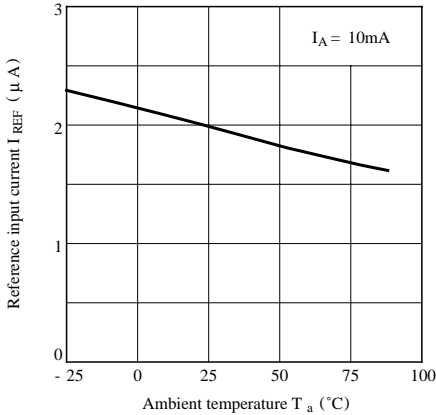

Fig.17 Reference Voltage Change vs. Anode Voltage

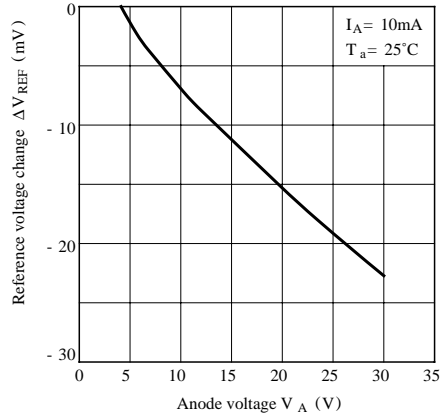
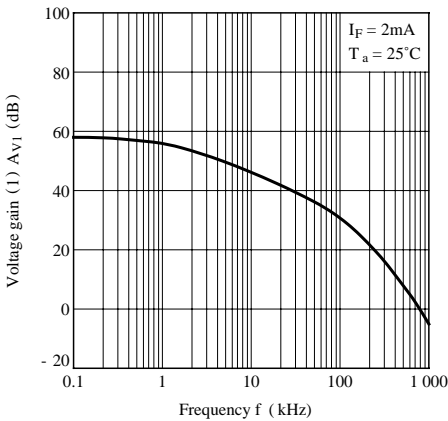
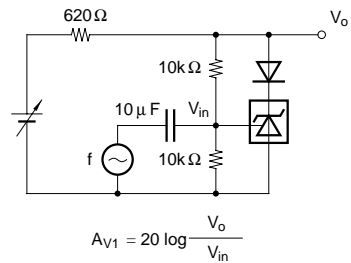

Fig.18-a Voltage Gain (1) vs. Frequency



Test Circuit for Voltage Gain (1) vs. Frequency



$$A_{V1} = 20 \log \frac{V_o}{V_{in}}$$

Fig.18-b Voltage Gain (2) vs. Frequency

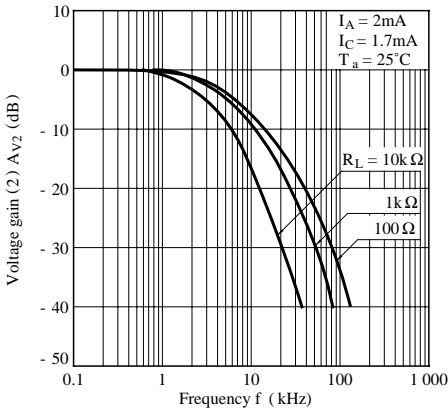

Test Circuit for Voltage Gain (2) vs. Frequency

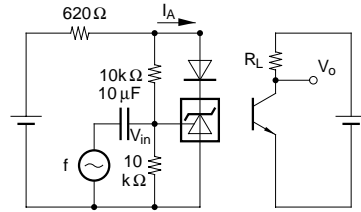
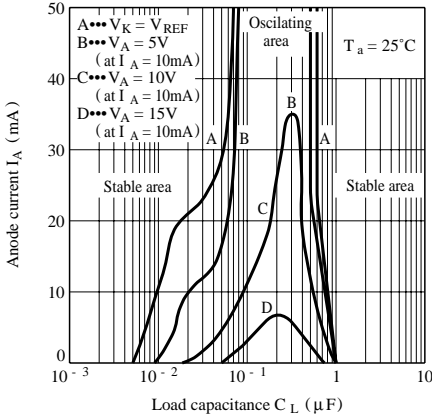

Fig.19 Anode Current vs. Load Capacitance



Test Circuit for Anode Current vs. Load Capacitance

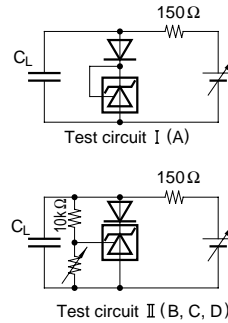

Fig.20 Collector-emitter Saturation Voltage vs. Ambient Temperature

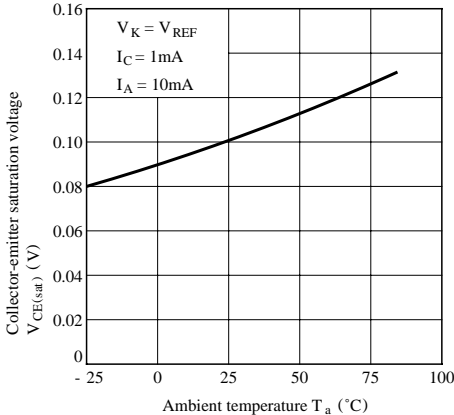
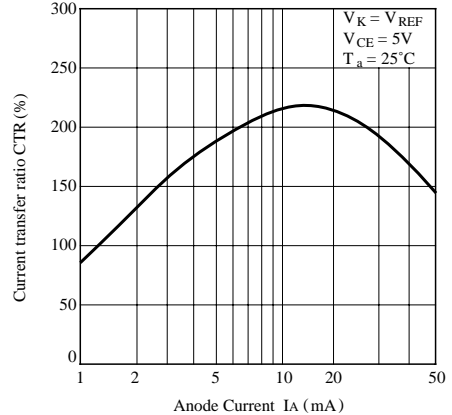

Fig.21 Current Transfer Ratio vs. Anode Current



■ Precautions for Use

Handle this product the same as with other integrated circuits against static electricity.

- As for other general cautions, refer to the chapter "Precautions for Use"