

# THYRISTOR MODULE

P C H 3 0 8

30A / 800V

## FEATURES

- \* Isolated Base
- \* Thyristor and Diode Cathode Common
- \* High Surge Capability
- \* UL Recognized, File No. E187184

## OUTLINE DRAWING

## TYPICAL APPLICATIONS

- \* Rectified For General Use

PCH

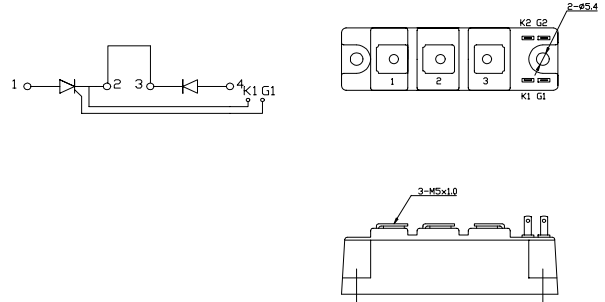

## Maximum Ratings

Approx Net Weight:155g

Parameter	Symbol	Grade	Unit
		PCH308	
Repetitive Peak Off-State Voltage	$V_{DRM}$	800	V
Non Repetitive Peak Off-State Voltage	$V_{DSM}$	960	
Repetitive Peak Reverse Voltage	$V_{RRM}$	800	V
Non Repetitive Peak Reverse Voltage	$V_{RSM}$	960	

Parameter		Conditions	Max Rated Value	Unit
Average Rectified Output Current	$I_{O(AV)}$	50Hz Half Sine Wave condition $T_c=95^\circ\text{C}$	30	A
RMS On-State Current	$I_{T(RMS)}$		47	A
Surge On-State Current	$I_{TSM}$	50 Hz Half Sine Wave, 1Pulse, Non-Repetitive	600	A
I Squared t	$I^2t$	2msec to 10msec	1800	$\text{A}^2\text{s}$
Critical Rate of Turned-On Current	$di/dt$	$V_D=2/3V_{DRM}$ , $I_{TM}=2 \cdot I_o$ , $T_j=125^\circ\text{C}$ $I_G=200\text{mA}$ , $di_G/dt=0.2\text{A}/\mu\text{s}$	100	$\text{A}/\mu\text{s}$
Peak Gate Power	$P_{GM}$		5	W
Average Gate Power	$P_{G(AV)}$		1	W
Peak Gate Current	$I_{GM}$		2	A
Peak Gate Voltage	$V_{GM}$		10	V
Peak Gate Reverse Voltage	$V_{RGM}$		5	V
Operating Junction Temperature Range	$T_{jw}$		-40 to +125	$^\circ\text{C}$
Storage Temperature Range	$T_{stg}$		-40 to +125	$^\circ\text{C}$
Isolation Voltage	Viso	Base Plate to Terminals, AC1min	2000	V
Mounting torque	Case mounting	Ftor	M5 Screw	N.m
	Terminals		M5 Screw	

Value per 1 Arm

**Electrical • Thermal Characteristics**

Characteristics	Symbol	Test Conditions	Maximum Value.			Unit
			Min.	Typ.	Max.	
Peak Off-State Current	$I_{DM}$	$V_{DM} = V_{DRM}, T_j = 125^\circ\text{C}$			10	mA
Peak Reverse Current	$I_{RM}$	$V_{RM} = V_{RRM}, T_j = 125^\circ\text{C}$			10	mA
Peak Forward Voltage	$V_{TM}$	$I_{TM} = 90\text{A}, T_j = 25^\circ\text{C}$			1.45	V
Gate Current to Trigger	$I_{GT}$	$V_D = 6\text{V}, I_T = 1\text{A}$	$T_j = -40^\circ\text{C}$		200	mA
			$T_j = 25^\circ\text{C}$		100	
			$T_j = 125^\circ\text{C}$		50	
Gate Voltage to Trigger	$V_{GT}$	$V_D = 6\text{V}, I_T = 1\text{A}$	$T_j = -40^\circ\text{C}$		4	V
			$T_j = 25^\circ\text{C}$		2.5	
			$T_j = 125^\circ\text{C}$		2	
Gate Non-Trigger Voltage	$V_{GD}$	$V_D = 2/3V_{DRM}, T_j = 125^\circ\text{C}$	0.25			V
Critical Rate of Rise of Off-State Voltage	dv/dt	$V_D = 2/3V_{DRM}, T_j = 125^\circ\text{C}$	500			V/ $\mu\text{s}$
Turn-Off Time	tq	$I_{TM} = I_O, V_D = 2/3V_{DRM}$ $dv/dt = 20\text{V}/\mu\text{s}, V_R = 100\text{V}$ $-di/dt = 20\text{A}/\mu\text{s}, T_j = 125^\circ\text{C}$		100		$\mu\text{s}$
Turn-On Time	tgt	$V_D = 2/3V_{DRM}, T_j = 125^\circ\text{C}$ $I_G = 200\text{mA}, di_G/dt = 0.2\text{A}/\mu\text{s}$		6		$\mu\text{s}$
Delay Time	td			2		$\mu\text{s}$
Rise Time	tr			4		$\mu\text{s}$
Latching Current	$I_L$	$T_j = 25^\circ\text{C}$		100		mA
Holding Current	$I_H$	$T_j = 25^\circ\text{C}$		50		
Thermal Resistance	Rth(j-c)	Junction to Case			0.7	$^\circ\text{C}/\text{W}$
	Rth(c-f)	Base Plate to Heat Sink with Thermal Compound			0.2	

Value Per 1Arm

PCH308 OUTLINE DRAWING (Dimensions in mm)

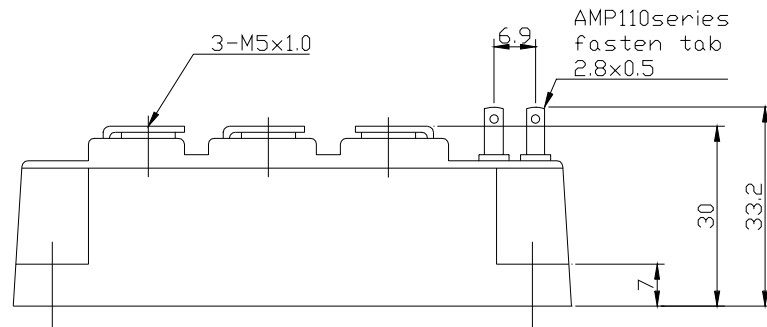
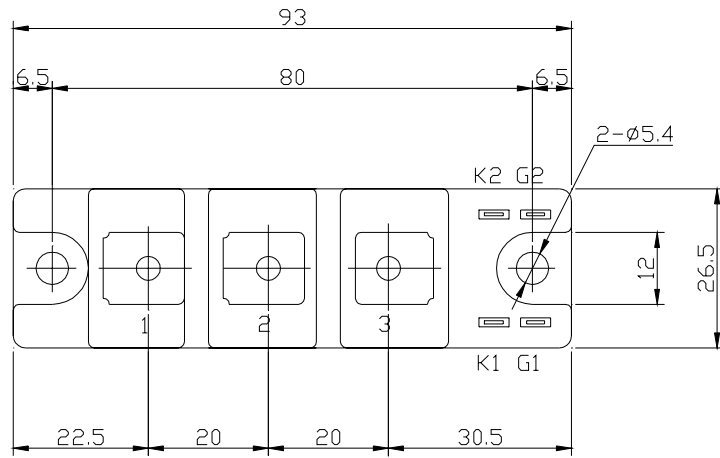

PCH

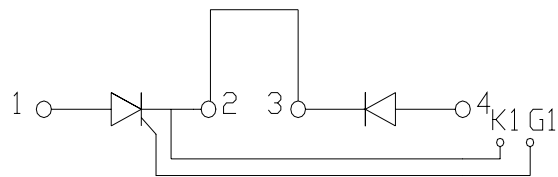

オン電圧特性  
ON-STATE CURRENT VS. VOLTAGE

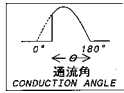
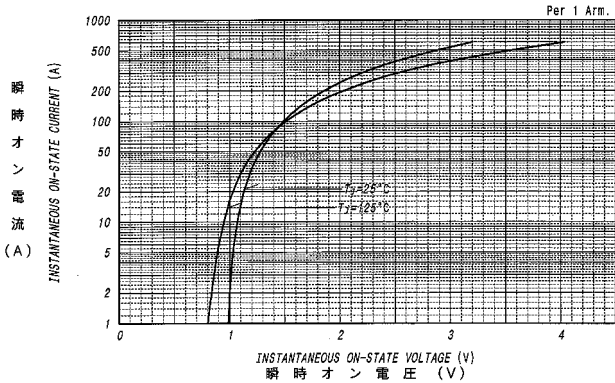

平均オン電力損失特性  
AVERAGE ON-STATE POWER DISSIPATION  
for SINUSOIDAL CURRENT WAVEFORM

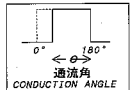
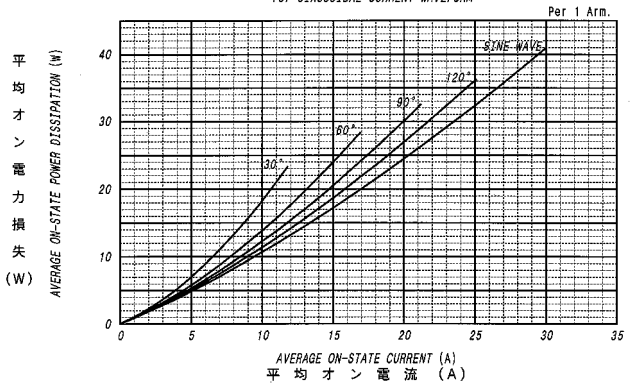

平均オン電力損失特性  
AVERAGE ON-STATE POWER DISSIPATION  
for RECTANGULAR CURRENT WAVEFORM

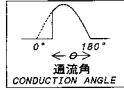
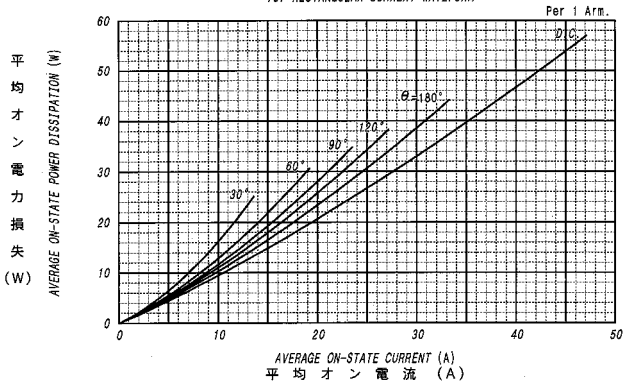

平均オン電流 - ケース温度定格  
AVERAGE ON-STATE CURRENT VS. CASE TEMPERATURE  
(50Hz SINUSOIDAL CURRENT WAVEFORM)

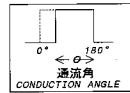
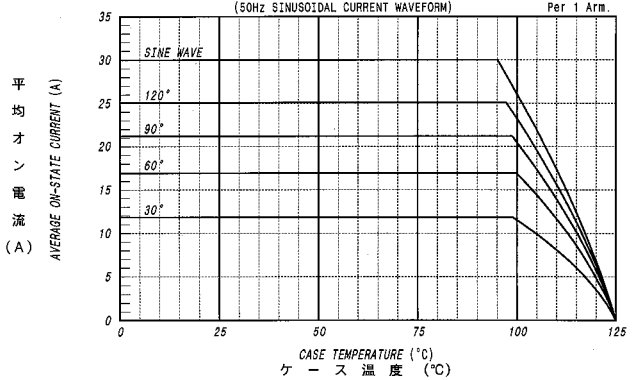

平均オン電流 - ケース温度定格  
AVERAGE ON-STATE CURRENT VS. CASE TEMPERATURE  
(50Hz RECTANGULAR CURRENT WAVEFORM)

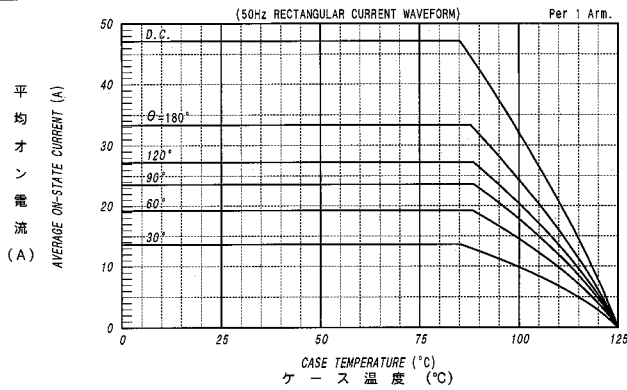

サージオン電流定格  
SURGE CURRENT RATINGS  
f=50Hz, Half Sine Wave, Non-Repetitive, Tj=125°C

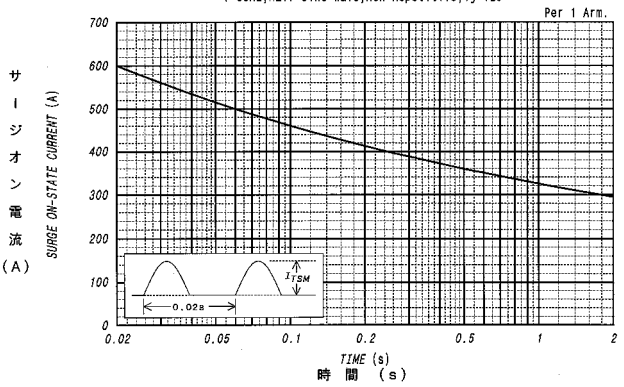

ゲート特性  
GATE CHARACTERISTICS

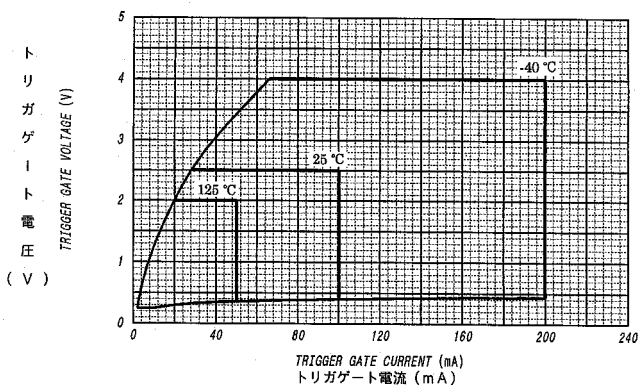

ゲート定格  
GATE RATINGS

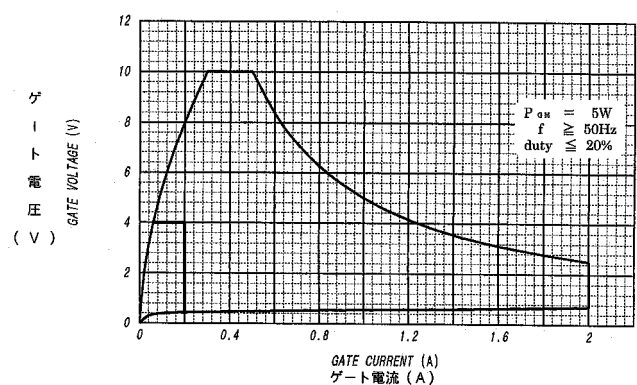

過渡熱抵抗特性  
MAXIMUM TRANSIENT THERMAL IMPEDANCE  
Junction to Case

Per 1 Arm.

