

User's Manual
For
PCL6045B
Pulse Control LSI

NPM
Nippon Pulse Motor Co., Ltd.

[Preface]

Thank you for considering our pulse control LSI, the "PCL6045B."

To learn how to use the PCL6045B, read this manual to become familiar with the product.

The handling precautions for installing this LSI are described at the end of this manual. Make sure to read them before installing the LSI.

In addition to this manual, the PLC6045B User's Manual, Application Version, will be available. It includes programming examples. Please contact us if you need a copy.

[Cautions]

- (1) Copying all or any part of this manual without written approval is prohibited.
- (2) The specifications of this LSI may be changed to improve performance or quality without prior notice.
- (3) Although this manual was produced with the utmost care, if you find any points that are unclear, wrong, or have inadequate descriptions, please let us know.
- (4) We are not responsible for any results that occur from using this LSI, regardless of item (3) above.

- Explanation of the descriptions in this manual

1. The "x" "y" "z" and "u" of terminal names and bit names refer to the X axis, Y axis, Z axis and U axis, respectively.
2. Terminals with a bar over the name (ex. \overline{RST}) are negative logic. Their logic cannot be changed. Terminals without a bar over the name are positive logic. Their output logic can be changed.
3. When describing the bits in registers, "n" refers to the bit position. A "0" means that the bit is in position 0, and that it is prohibited to write to any bit other than the "0" bit. Finally, this bit will always return a "0" when read.

INDEX

1. Outline and Features	1
1-1. Outline.....	1
1-2. Features	1
2. Specifications	5
3. Terminal Assignment Diagram	6
4. Function of Terminals	7
5. Block Diagram	12
6. CPU Interface.....	13
6-1. Setting up connections to a CPU	13
6-2. Precautions for designing hardware	13
6-3. CPU interface circuit block diagram	14
6-4. Address map	16
6-4-1. Axis arrangement map	16
6-4-2. Internal map of each axis.....	16
6-5. Description of the map details	18
6-5-1. Write the command code and axis selection (COMW, COMB)	18
6-5-2. Write to an output port (OTPW, OTPB)	18
6-5-3. Write/read the input/output buffer (BUFW, BUFB)	18
6-5-4. Reading the main status (MSTSW, MSTSB)	19
6-5-5. Reading the sub status and input/output port. (SSTSW, SSTSB, IOPB)	20
7. Commands (Operation and Control Commands).....	21
7-1. Operation commands.....	21
7-1-1. Procedure for writing an operation command.....	21
7-1-2. Start command.....	21
7-1-3. Speed change command.....	22
7-1-4. Stop command.....	22
7-1-5. NOP (do nothing) command	22
7-2. General-purpose output bit control commands	23
7-3. Control command	24
7-3-1. Software reset command.....	24
7-3-2. Counter reset command	24
7-3-3. ERC output control command.....	24
7-3-4. Pre-register control command.....	24
7-3-5. PCS input command.....	24
7-3-6. LTCH input (counter latch) command.....	24
7-4. Register control command	25
7-4-1. Procedure for writing data to a register	25
7-4-2. Procedure for reading data from a register	25
7-4-3. Table of register control commands	26
7-5. General-purpose output port control command	27
7-5-1. Command writing procedures	27
7-5-2. Command bit allocation	27

8. Registers.....	28
8-1. Table of registers	28
8-2. Pre-registers.....	29
8-2-1. Writing to the operation pre-registers	29
8-2-2. Cancel the pre-register operations	30
8-2-3. Writing to the comparator pre-registers	30
8-2-4. Cancel the comparator pre-register data	30
8-3. Description of the registers.....	31
8-3-1. PRMV (RMV) registers (Feed amount, target position)	31
8-3-2. PRFL (RFL) registers (Initial speed)	31
8-3-3. PRFH (RFH) registers (Operation speed)	31
8-3-4. PRUR (RUR) registers (Acceleration rate).....	31
8-3-5. PRDR (RDR) registers (Deceleration rate)	32
8-3-6. PRMG (RMG) registers (Speed magnification rate)	32
8-3-7. PRDP (RDP) registers (Ramping-down point).....	32
8-3-8. PRMD (RMD) registers (Operation mode).....	33
8-3-9. PRIP (RIP) registers (Circular interpolation center position, master axis feed amount).....	35
8-3-10. PRUS (RUS) registers (S-curve acceleration range)	35
8-3-11. PRDS (RDS) registers (S-curve deceleration range)	35
8-3-12. RFA register (Speed at amount correction)	35
8-3-13. RENV1 register (Environment setting 1)	36
8-3-14. RENV2 register (Environment setting 2)	38
8-3-15. RENV3 register (Environment setting 3)	40
8-3-16. RENV4 register (Environment setting 4)	42
8-3-17. RENV5 register (Environment setting 5)	44
8-3-18. RENV6 register (Environment setting 6)	45
8-3-19. RENV7 register (Environment setting 7)	45
8-3-20. RCUN1 register (COUNTER1 <command position>)	46
8-3-21. RCUN2 register (COUNTER2 <mechanical position>).....	46
8-3-22. RCUN3 register (COUNTER3 <deflection counter>).....	46
8-3-23. RCUN4 register (COUNTER4 <general-purpose counter>)	46
8-3-24. RCMP1 register (Comparison data for Comparator 1)	47
8-3-25. RCMP2 register (Comparison data for Comparator 2)	47
8-3-26. RCMP3 register (Comparison data for Comparator 3)	47
8-3-27. RCMP4 register (Comparison data for Comparator 4)	47
8-3-28. RCMP5 register (Comparison data for Comparator 5)	47
8-3-29. RIRQ register (Specify event interruption cause)	48
8-3-30. RLTC1 register (COUNTER1 latch data).....	48
8-3-31. RLTC2 register (COUNTER2 latch data).....	48
8-3-32. RLTC3 register (COUNTER3 latch data).....	49
8-3-33. RLTC4 register (COUNTER4 latch data).....	49
8-3-34. RSTS register (Extension status).....	50
8-3-35. REST register (Error INT status).....	51
8-3-36. RIST register (Event INT status).....	52
8-3-37. RPLS register (Number of pulses left for feeding)	52
8-3-38. RSPD register (EZ counter, current speed monitor)	53
8-3-39. RSDC register (Automatically calculated ramping-down point)	53
8-3-40. PRCI (RCI) registers (Number of steps for interpolation)	53
8-3-41. RCIC register (Circular interpolation step number counter)	53
8-3-42. RIPS register (Interpolation status)	54

9. Operation Mode	55
9-1. Continuous operation mode using command control	55
9-2. Positioning operation mode.....	55
9-2-1. Positioning operation (specify a target position using an incremental value)	55
9-2-2. Positioning operation (specify the absolute position COUNTER1)	56
9-2-3. Positioning operation (specify the absolute position COUNTER2)	56
9-2-4. Command position 0 return operation	56
9-2-5. Machine position 0 return operation	56
9-2-6. One pulse operation	56
9-2-7. Timer operation	57
9-3. Pulsar (PA/PB) input mode	58
9-3-1. Continuous operation using a pulsar input	61
9-3-2. Positioning operations using a pulsar input (specify incremental position)	61
9-3-3. Positioning operations using a pulsar input (specify absolute position to COUNTER1).....	61
9-3-4. Positioning operations using a pulsar input (specify absolute position to COUNTER2).....	61
9-3-5. Command position zero return operation using a pulsar input	62
9-3-6. Mechanical position zero return operation using a pulsar input.....	62
9-3-7. Continuous linear interpolation 1 using a pulsar input	62
9-3-8. Linear interpolation 1 using pulsar input.....	62
9-3-9. Continuous linear interpolation 2 using pulsar input	62
9-3-10. Linear interpolation 2 using pulsar input.....	62
9-3-11. CW circular interpolation using pulsar input.....	62
9-3-12. CCW circular interpolation using pulsar input.....	62
9-4. External switch (\pm DR) operation mode	63
9-4-1. Continuous operation using an external switch	63
9-4-2. Positioning operation using an external switch.....	64
9-5. Zero position operation mode	65
9-5-1. Zero return operation.....	66
9-5-2. Leaving the zero position operations.....	74
9-5-3. Zero search operation	74
9-6. EL or SL operation mode	75
9-6-1. Feed until reaching an EL or SL position.....	76
9-6-2. Leaving an EL or SL position	76
9-7. EZ count operation mode.....	76
9-8. Interpolation operations	77
9-8-1. Interpolation operations	77
9-8-2. Interpolation control axis.....	77
9-8-3. Constant synthesized speed control	78
9-8-4. Continuous linear interpolation 1 (MOD: 60h)	79
9-8-5. Linear interpolation 1 (MOD: 61h).....	79
9-8-6. Continuous linear interpolation 2 (MOD: 62h)	80
9-8-7. Linear interpolation 2 (MOD: 63h).....	80
9-8-8. Circular interpolation.....	81
9-8-9. Circular interpolation synchronized with the U axis.....	83
9-8-10. Interpolation operation synchronized with PA/ PB	83
9-8-11. Operation during interpolation.....	83
10. Speed Patterns.....	85
10-1. Speed patterns.....	85
10-2. Speed pattern settings	86
10-3. Manual FH correction	90
10-4. Example of setting up an acceleration/deceleration speed pattern	94
10-5. Changing speed patterns while in operation	95

11. Description of the Functions.....	96
11-1. Reset.....	96
11-2. Position override.....	97
11-2-1. Target position override 1.....	97
11-2-2. Target position override 2 (PCS signal).....	98
11-3. Output pulse control.....	99
11-3-1. Output pulse mode.....	99
11-3-2. Control the output pulse width and operation complete timing.....	100
11-4. Idling control.....	101
11-5. Mechanical external input control.....	102
11-5-1. +EL, -EL signal.....	102
11-5-2. SD signal.....	102
11-5-3. ORG, EZ signals.....	105
11-6. Servomotor I/F.....	106
11-6-1. INP signal.....	106
11-6-2. ERC signal.....	107
11-6-3. ALM signals.....	108
11-7. External start, simultaneous start.....	109
11-7-1. CSTA STA signal.....	109
11-7-2. PCS signal.....	110
11-8. External stop / simultaneous stop.....	111
11-9. Emergency stop.....	112
11-10. Counter.....	113
11-10-1. Counter type and input method.....	113
11-10-2. Counter reset.....	115
11-10-3. Latch the counter and count condition.....	116
11-10-4. Stop the counter.....	117
11-11. Comparator.....	118
11-11-1. Comparator types and functions.....	118
11-11-2. Software limit function.....	122
11-11-3. Out of step stepper motor detection function.....	123
11-11-4. IDX (synchronous) signal output function.....	124
11-11-5. Ring count function.....	125
11-12. Backlash correction and slip correction.....	126
11-13. Vibration restriction function.....	127
11-14. Synchronous starting.....	128
11-14-1. Start triggered by another axis stopping.....	129
11-14-2. Starting from an internal synchronous signal.....	132
11-15. Output an interrupt signal.....	135
12. Electrical Characteristics.....	138
12-1. Absolute maximum ratings.....	138
12-2. Recommended operating conditions.....	138
12-3. DC characteristics.....	139
12-4. AC characteristics 1) (reference clock).....	139
12-5. AC characteristics 2) (CPU I/F).....	140
12-5-1. CPU-I/F 1) (IF1 = H, IF0 = H) Z80.....	140
12-5-2. CPU-I/F 2) (IF1 = H, IF0 = L) 8086.....	141
12-5-3. CPU-I/F 3) (IF1 = L, IF0 = L) H8.....	142
12-5-4. CPU-I/F 4) (IF1 = L, IF0 = L) 68000.....	143
12-6. Operation timing.....	144
13. External Dimensions.....	146
Appendix: List of various items.....	147
Appendix 1: List of commands.....	147
Appendix 2: Setting speed pattern.....	149
Appendix 3: Label list.....	153

Appendix 4: Differences between the PCL6045 and PCL6045B162

Handling Precautions166

- 1. Design precautions166
- 2. Precautions for transporting and storing LSIs166
- 3. Precautions for installation166
- 4. Other precautions168

1. Outline and Features

1-1. Outline

The PCL6045B is a CMOS LSI designed to provide the oscillating, high-speed pulses needed to drive stepper motors and servomotors (pulse string input types).

It can offer various types of control over the pulse strings and therefore the motor performance. These include continuous feeding, positioning, zero return at a constant speed, linear acceleration/deceleration, and S-curve acceleration/deceleration.

The PLC6045B controls four axes. It can control the linear interpolation of two to four axes, circular interpolations between any two axes, confirm PCL operation status, and interrupt output with various conditions. It also integrates an interface for servo control drivers.

These functions can be used with simple commands. The intelligent design philosophy reduces the burden on the CPU units to control motors.

1-2. Features

◆ CPU-I/F

The PCL6045B contains the following CPU interface circuits.

- 1) 8-bit interface for Z80 CPU.
- 2) 16-bit interface for 8086 CPU.
- 3) 16-bit interface for H8 CPU.
- 4) 16-bit interface for 68000 CPU.

◆ Acceleration/Deceleration speed control

Linear acceleration/deceleration and S-curve acceleration/deceleration are available.

Linear acceleration/deceleration can be inserted in the middle of an S-curve acceleration/deceleration curve. (Specify the S-curve range.)

The S-curve range can specify each acceleration and deceleration independently. Therefore, you can create an acceleration/deceleration profile that consists of linear acceleration and S-curve deceleration, or vice versa.

◆ Interpolation operation

Feeding with linear interpolation of any two to four axes and circular interpolation of any two axes are both possible.

◆ Speed override

The feed speed can be changed in the middle of any feed operation.

However, the feed speed cannot be changed during operation when the synthesized speed constant control for linear interpolation is ON while using S-curve deceleration.

◆ Overriding target position 1) and 2)

1) The target position (feed amount) can be changed while feeding in the positioning mode.

If the current position exceeds the newly entered position, the motor will decelerate, stop (immediate stop when already feeding at a low speed), and then feed in the reverse direction.

2) Starts operation the same as in the continuous mode and, when it receives an external signal, it will stop after the specified number of pulses.

◆ Triangle drive elimination (FH correction function)

In the positioning mode, when there are a small number of output pulses, this function automatically lowers the maximum speed and eliminates triangle driving.

◆ Look ahead function

The next two sets of data (feed amount, initial speed, feed speed, acceleration rate, deceleration rate, speed magnification rate, ramping-down point, operation mode, center of circular interpolation, S-curve range on an acceleration, S-curve range on a deceleration, number of steps for circular interpolation) can be written while executing the current data. The next set of data, and other sets of data, can be written in advance of their execution for checking by the comparator.

When the current operation is complete, the system will immediately execute the next operation.

◆ A variety of counter circuits

The following four counters are available separately for each axis.

Counter	Use or purpose	Counter Input/Output
COUNTER1	28-bit counter for control of the command position	Outputs pulses
COUNTER2	28-bit counter for mechanical position control (Can be used as general-purpose counter)	EA/EB input Outputs pulses PA/PB input
COUNTER3	16-bit counter for controlling the deviation between the command position and the machine's current position	Outputs pulses and EA/EB input Outputs pulses and PA/PB input EA/EB input and PA/PB input
COUNTER4	28-bit counter used to output synchronous signals (Can be used as general-purpose counter)	Outputs pulses EA/EB input PA/PB input 1/2 of reference clock

All counters can be reset by writing a command or by providing a CLR signal.

They can also be latched by writing a command, or by providing an LTC or ORG signal.

The PCL6045B can also be set to reset automatically soon after latching these signals.

The COUNTER1, COUNTER2, and COUNTER4 counters have a ring count function that repeats counting through a specified counting range.

◆ Comparator

There are five comparator circuits for each axis. They can be used to compare target values and internal counter values.

The counter to compare can be selected from COUNTER1 (command position counter), COUNTER2 (mechanical position counter), COUNTER3 (deflection counter), and COUNTER4 (a general-purpose counter).

Comparators 1 and 2 can also be used as software limits (+SL, -SL).

◆ Software limit function

You can set software limits using two of the comparator's circuits.

When the mechanical position approaches the software limit range, the LSI will instruct the motors to stop immediately or to stop by deceleration. After that these axes can only be moved in the direction opposite their previous travel.

◆ Backlash correction function / Slip correction function

The LSI has a backlash correction function. Each time the feed direction is changed, the LSI applies a backlash correction. However, the backlash correction cannot be applied while performing a circular interpolation.

◆ Synchronous signal output function / Slip correction function

Both the backlash and slip corrections are available.

Backlash correction corrects the feed amount each time the feed direction is changed. Slip correction corrects the feed amount regardless of the feed direction.

◆ Simultaneous start function

Multiple axes controlled by the same LSI, or controlled by multiple sets of this LSI, can be started at the same time.

◆ Simultaneous stop function

Multiple axes controlled by the same LSI, or controlled by multiple sets of this LSI, can be stopped at the same time by a command, by an external signal, or by an error stop on any axis.

◆ Vibration restriction function

Specify a control constant in advance and add one pulse each for reverse and forward feed just before

stopping.

Using this function, vibration can be decreased while stopping.

◆ Manual pulsar input function

By applying manual pulse signals (PA/PB), you can rotate a motor directly.

The input signals can be 90° phase difference signals (1x, 2x, or 4x) or up and down signals.

In addition to the magnification rates above, the PCL6045B contains an integral pulse number magnification circuit which multiplies by 1x to 32x and a pulse quantity division circuit which is divided by 1 to 2048. Software limit settings can be used, and the PCL stops the output of pulses. It can also feed in the opposite direction.

◆ Direct input of operation switch

Positive and negative direction terminals (\pm DR) are provided to drive a motor with an external operation switch.

These switches turn the motor forward (+) and backward (-).

◆ Out-of-step detection function

This LSI has a deflection counter which can be used to compare command pulses and encoder signals (EA/EB).

It can be used to detect out-of-step operation and to confirm a position by using a comparator.

◆ Idling pulse output function

This function outputs a preset number of pulses at the self start frequency (FL) before a high-speed start acceleration operation.

When the initial speed is set higher during the acceleration, this function is effective in preventing out-of-step operation.

◆ Operation mode

The basic operations of this LSI are: continuous operation, positioning, zero return, linear interpolation, and circular interpolation. By setting the optional operation mode bits, you can use a variety of operations.

<Examples of the operation modes>

- 1) Start/stop by command.
- 2) Continuous operation and positioning operation using PA/PB inputs (manual pulsar).
- 3) Operate for specified distances or in continuous operation using +DR/-DR signals (drive switch).
- 4) Zero return operation.
- 5) Positioning operation using commands.
- 6) Hardware start of the positioning operation using $\overline{\text{CSTA}}$ input.
- 7) Change the target position after turning ON the PCS. (Delay control)

◆ Variety of zero return sequences (Homing)

The following patterns can be used.

- 1) Feeds at low speed and stops when the ORG signal is turned ON
- 2) Feeds at low speed and stops when an EZ signal is received (after the ORG signal is turned ON).
- 3) Feeds at low speed, reverses when the ORG signal is turned ON, and stops when an EZ signal is received.
- 4) Feeds at low speed and stops when the EL signal is turned ON. (Normal stop)
- 5) Feeds at low speed, reverses when the EL signal is turned ON, and stops when an EZ signal is received.
- 6) Feeds at high speed, decelerates when the SD signal is turned ON, and stops when the ORG signal is turned ON.
- 7) Feeds at high speed, decelerates when the ORG signal is turned ON, and stops when an EZ signal is received.
- 8) Feeds at high speed, decelerates and stops after the ORG signal is turned ON. Then, it reverse feeds and stops when an EZ signal is received.
- 9) Feeds at high speed, decelerates and stops by memorizing the position when the ORG signal is turned ON, and stops at the memorized position.
- 10) Feeds at high speed, decelerates to the position stored in memory when an EZ signal is received after the ORG signal is turned ON. Then, returns to the memorized position if an overrun occurs.

11) Feeds at high speed, reverses after a deceleration stop triggered by the EL signal, and stops when an EZ signal is received.

◆ Mechanical input signals

The following four signals can be input for each axis.

- 1) +EL: When this signal is turned ON, while feeding in the positive (+) direction, movement on this axis stops immediately (with deceleration). When this signal is ON, no further movement occurs on the axis in the positive (+) direction. (The motor can be rotated in the negative (-) direction.)
- 2) -EL: Functions the same as the +EL signal except that it works in the negative (-) direction.
- 3) SD: This signal can be used as a deceleration signal or a deceleration stop signal, according to the software setting. When this is used as a deceleration signal, and when this signal is turned ON during a high speed feed operation, the motor on this axis will decelerate to the FL speed. If this signal is ON and movement on the axis is started, the motor on this axis will run at the FL low speed. When this signal is used as a deceleration stop signal, and when this signal is turned ON during a high speed feed operation, the motor on this axis will decelerate to the FL speed and then stop.
- 4) ORG: Input signal for a zero return operation.
For safety, make sure the +EL and -EL signals stay on from the EL position until the end of each stroke. The input logic for these signals can be changed using the ELL terminal.
The input logic of the +EL and -EL signals can be changed with the ELL terminal.
The input logic of the SD and ORG signals can be changed using software.

◆ Digital servomotor I/F

The following three signals can be used as an interface for each axis

- 1) INP: Input positioning complete signal that is output by a servomotor driver.
- 2) ERC: Output deflection counter clear signal to a servomotor driver.
- 3) ALM: Regardless of the direction of operation, when this signal is ON, movement on this axis stops immediately (deceleration stop). When this signal is ON, no movement can occur on this axis.
The input logic of the INP, ERC, and ALM signals can be changed using software.
The ERC signal is a pulsed output. The pulse length can be set. (12 μ sec to 104 msec. A level output is also available.)

◆ Output pulse specifications

Output pulses can be set to a common pulse or 2-pulse mode. The output logic can also be selected.

◆ Emergency stop signal ($\overline{\text{CEMG}}$) input

When this signal is turned ON, movement on both axes stops immediately. While this signal is ON, no movement is allowed on either axes.

◆ Interrupt signal output

An $\overline{\text{INT}}$ signal (interrupt request) can be output for many reasons.

The $\overline{\text{INT}}$ terminal output signal can use ORed logic for lots of conditions on each axis. (When more than one 6045B LSI is used, wired OR connections are not possible.)

2. Specifications

Item	Description
Number of axes	4 axes (X, Y, Z, and U axis)
Reference clock	Standard: 19.6608 MHz (Max. 20 MHz)
Positioning control range	-134,217,728 to +134,217,727 (28-bit)
Ramping-down point setting range	0 to 16,777,215 (24-bit)
Number of registers used for setting speeds	Three for each axis (FL, FH, and FA (speed correction))
Speed setting step range	1 to 65,535 (16-bits)
Speed magnification range	Multiply by 0.1 to 100 Multiply by 0.1 = 0.1 to 6,553.5 pps Multiply by 1 = 1 to 65,535 pps Multiply by 100 = 100 to 6,553,500 pps (When the reference clock is 19.6608 MHz)
Acceleration/deceleration characteristics	Selectable acceleration/deceleration pattern for both increasing and decreasing speed separately, using Linear and S-curve acceleration/deceleration.
Acceleration rate setting range	1 to 65,535 (16-bit)
Deceleration rate setting range	1 to 65,535 (16-bit)
Ramping-down point automatic setting	Automatic setting within the range of (deceleration time) < (acceleration time x 2)
Feed speed automatic correction function	Automatically lowers the feed speed for short distance positioning moves.
Manual operation input	Manual pulsar input, pushbutton switch input
Counter	COUNTER1: Command position counter (28-bit) COUNTER2: Mechanical position counter (28-bit) COUNTER3: Deflection counter (16-bit) COUNTER4: General-purpose counter (28-bit)
Comparators	28-bits x 5 circuits / axis
Interpolation functions	Linear interpolation: Any 2 to 4 axes, Circular interpolation: Any 2 axes
Operating temperature range	-40 to +70°C
Power supply	Two power supplies of +5V±10% and 3.3 V±10%
Package	176-pin QFP

3. Terminal Assignment Diagram

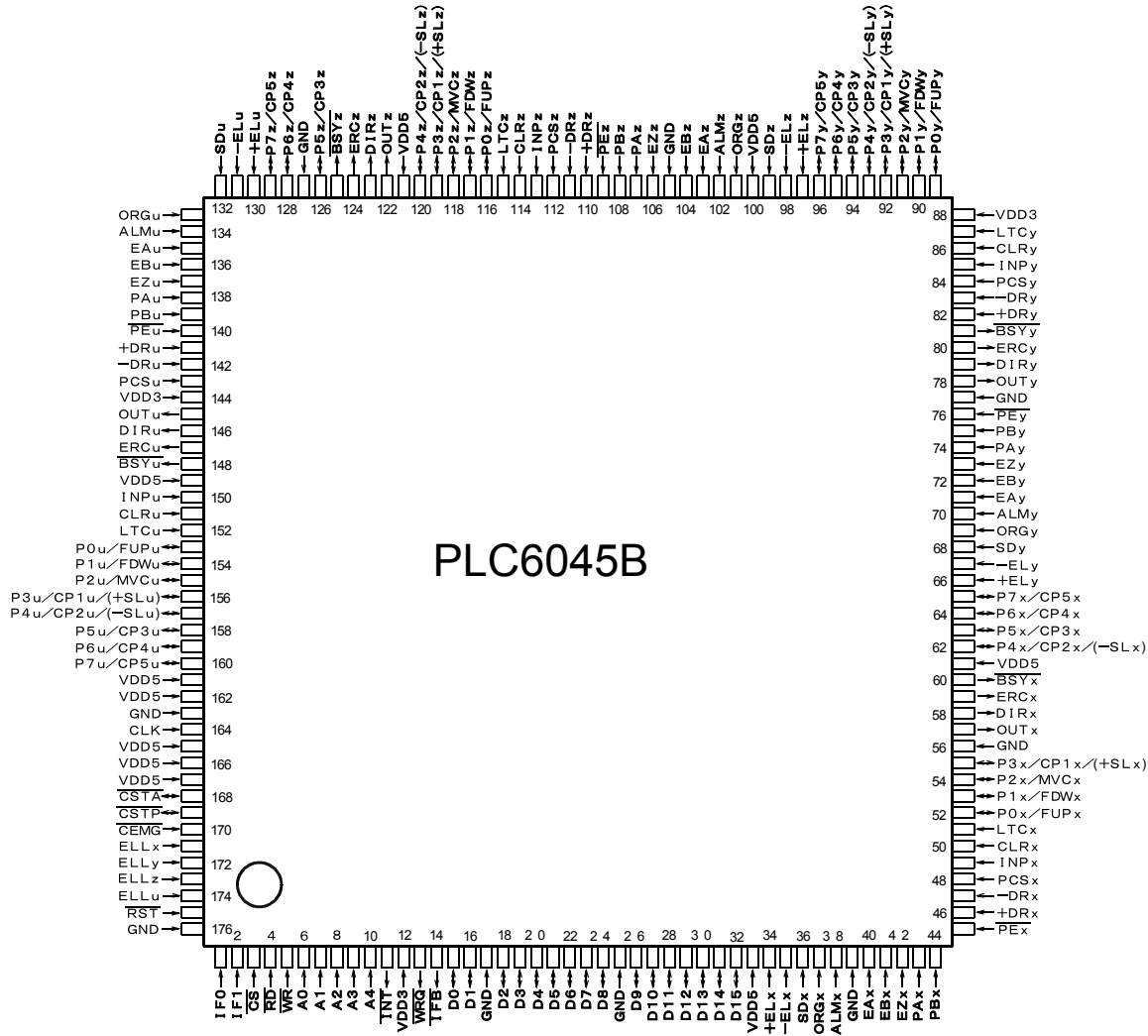

4. Functions of Terminals

Signal name	Terminal No.	Input/output	Logic	Description																																							
GND	17, 25, 39, 56, 77, 105, 127, 163, 176	Power source		Supply a negative power. Make sure to connect all of these terminals.																																							
VDD5	33, 61, 100, 121, 149, 161, 162, 165, 166, 167	Power source		Supply +5 VDC power. The allowable power supply range is +5 VDC $\pm 10\%$. Make sure to connect all of these terminals.																																							
VDD3	12, 88, 144	Power source		Supply +3.3 VDC power. The allowable power supply range is +3.3 VDC $\pm 10\%$. Make sure to connect all of these terminals.																																							
RST	175	Input	Negative	Input reset signal. Make sure to set this signal LOW after turning ON the power and before starting operation. Input and holding RST low for at least 8 cycles of the reference clock. For details about the chip's status after a reset, see section 11-1, "Reset", in this manual.																																							
CLK	164	Input		Input a CMOS level reference clock signal. (Signals other than the CLK are TTL level inputs.) The reference clock frequency is 19.6608 MHz. The LSI creates output pulses based on the clock input on this terminal.																																							
IF0 IF1	1 2	Input		Enter the CPU-I/F mode <table border="1" style="margin-left: auto; margin-right: auto;"> <thead> <tr> <th rowspan="2">IF1</th> <th rowspan="2">IF0</th> <th rowspan="2">CPU example</th> <th colspan="4">CPU signal connected to the terminal</th> </tr> <tr> <th>RD</th> <th>WR</th> <th>A0</th> <th>WRQ</th> </tr> </thead> <tbody> <tr> <td>L</td> <td>L</td> <td>68000</td> <td>+5 V</td> <td>R/W</td> <td>LDS</td> <td>DTACK</td> </tr> <tr> <td>L</td> <td>H</td> <td>H8</td> <td>RD</td> <td>HWR</td> <td>(GND)</td> <td>WAIT</td> </tr> <tr> <td>H</td> <td>L</td> <td>8086</td> <td>RD</td> <td>WR</td> <td>(GND)</td> <td>READY</td> </tr> <tr> <td>H</td> <td>H</td> <td>Z80</td> <td>RD</td> <td>WR</td> <td>A0</td> <td>WAIT</td> </tr> </tbody> </table>	IF1	IF0	CPU example	CPU signal connected to the terminal				RD	WR	A0	WRQ	L	L	68000	+5 V	R/W	LDS	DTACK	L	H	H8	RD	HWR	(GND)	WAIT	H	L	8086	RD	WR	(GND)	READY	H	H	Z80	RD	WR	A0	WAIT
IF1	IF0	CPU example	CPU signal connected to the terminal																																								
			RD	WR	A0	WRQ																																					
L	L	68000	+5 V	R/W	LDS	DTACK																																					
L	H	H8	RD	HWR	(GND)	WAIT																																					
H	L	8086	RD	WR	(GND)	READY																																					
H	H	Z80	RD	WR	A0	WAIT																																					
CS	3	Input	Negative	When the signal level on this terminal is LOW, the RD and WR terminals will be valid.																																							
RD WR	4 5	Input	Negative	Connect the I/F signals to the CPU. The RD and WR terminals are valid when CS terminal is LOW.																																							
A0 to A3	6 to 10	Input	Positive	Address control signals																																							
INT	11	Input	Negative	Outputs an interrupt request signal (IRQ) to an external CPU. After this terminal is turned ON, the signal will return to OFF when a RESET (error interrupt cause) or RIST (event interrupt cause) signal is received. The output status can be checked with an MSTSW (main status) command signal. The INT signal can be masked. When more than one 6045B LSI is used, a wired OR connection between INT terminals is not allowed.																																							
WRQ	13	Output	Negative	Outputs a wait request signal to cause a CPU to wait. The LSI needs 4 reference clock cycles to process each command. If the WRQ signal is not used, make sure that an external CPU does not access this LSI during this interval.																																							

Signal name	Terminal No.	Input/output	Logic	Description
IFB	14	Output	Negative	Signal used to indicate that the LSI is processing commands. Use this signal to make connections with a CPU that does not have a wait control input terminal. When the LSI receives a write command from a CPU, this signal will go LOW. When the LSI finishes processing, this signal will go HIGH. The LSI makes sure that this terminal is HIGH and then proceeds to the next step.
D0 to D7	15 to 16, 18 to 23	Input/ Output	Positive	Bi-directional data bus. When connecting a 16-bit data bus, connect the lower 8 signal lines here.
D8 to D15	24, 26 to 32	Input/ Output	Positive	Bi-directional data bus. When connecting a 16-bit data bus, connect the upper 8 signal lines here. A Z80-I/F (IF1 = H, IF0 = H) is used. Provide a pull up resistor (5k to 10 K-ohms) on VDD5. (One resistor can be used for all 8 lines.)
CSTA	168	Input/ Output *	Negative	Input/Output terminal for simultaneous start. When more than one LSI is used and you want to start them simultaneously, connect this terminal on each LSI. The terminal status can be checked using an RSTS command signal (extension status).
CSTP	169	Input/ Output *	Negative	Input/Output terminal for a simultaneous stop. (See Note 6.) When more than one LSI is used and you want to stop them simultaneously, connect this terminal on each LSI. The terminal status can be checked using an RSTS command signal (extension status).
CEMG	170	Input U	Negative	Input for an emergency stop. While this signal is LOW, the PCL cannot start. If this signal changes to LOW while in operation, all the motors will stop operation immediately.
ELLx ELLy ELLz ELLu	171 172 173 174	Input U		Specify the input logic for the ±EL signal. LOW: The input logic on ±EL is positive. HIGH: The input logic on ±EL is negative.
+ ELLx + ELLy + ELLz + ELLu	34 66 97 130	Input U	Negative %	Input end limit signal in the positive (+) direction. (See Note 6.) When this signal is ON while feeding in the positive (+) direction, the motor on that axis will stop immediately or will decelerate and stop. Specify the input logic using the ELL terminal. The terminal status can be checked using an SSTSW command signal (sub status).
- ELLx - ELLy - ELLz - ELLu	35 67 98 131	Input U	Negative %	Input end limit signal in the negative (-) direction. (See Note 6.) When this signal is ON while feeding in negative (-) direction, the motor on that axis will stop immediately, or will decelerate and stop. Specify the input logic using the ELL terminal. The terminal status can be checked using an SSTSW command signal (sub status).
SDx SDy SDz SDu	36 68 99 132	Input U	Negative #	Input deceleration signal. Selects the input method: LEVEL or LATCHED inputs. The input logic can be selected using software. The terminal status can be checked using an SSTSW command signal (sub status).

Signal name	Terminal No.	Input/output	Logic	Description
ORGx ORGy ORGz ORGu	37 69 101 133	Input U	Negative #	Input zero position signal. Used for zero return and other operations. (Edge detection.) The input logic can be selected using software. The terminal status can be checked using an SSTSW command signal (sub status).
ALMx ALMy ALMz ALMu	38 70 102 134	Input U	Negative #	Input alarm signal. (See Note 6.) When this signal is ON, the motor on that axis stops immediately, or will decelerate and stop. The input logic can be selected using software. The terminal status can be checked using an SSTSW command signal (sub status).
OUTx OUTy OUTz OUTu	57 78 122 145	Output	Negative #	Outputs command pulses for controlling a motor, or outputs direction signals. When Common Pulse mode is selected: Outputs a direction signal. When 2-pulse output mode is selected: Outputs pulses in the negative (-) direction. The output logic can be changed using software.
DIRx DIRy DIRz DIRu	58 79 123 146	Output	Negative #	Output command pulses for controlling a motor, or outputs direction signal. When Common Pulse mode is selected: Outputs a direction signal. When 2-pulse output mode is selected: Output pulses in the negative (-) direction. The output logic can be changed using software
EAx, EBx EAy, EBy EAz, EBz EAu, EBu	40, 41 71, 72 103, 104 135, 136	Input U		Input this signal when you want to control the mechanical position using the encoder signal. Input a 90° phase difference signal (1x, 2x, 4x) or input positive (+) pulses on EA and negative (-) pulses on EB. When inputting 90° phase difference signals, if the EA signal phase is ahead of the EB signal, the LSI will count pulses. The counting direction can be changed using software.
EZx E Zy E Zz E Zu	42 73 106 137	Input U	Negative #	Input a marker signal (this signal is output once for each turn of the encoder) when using the marker signal in zero return mode. Use of the EZ signal improves zero return precision. The input logic can be changed using software. The terminal status can be checked using an RSTS command signal (extension status).
PAX, PBx PAY, PBy PAZ, PBz PAU, PBu	43,44 74,75 107,108 138,139	Input U		Input for receiving external drive pulses, such as manual pulsar. You can input 90° phase difference signals (1x, 2x, 4x) or positive (+) pulses (on PA) and negative (-) pulses (on PB). When 90° phase difference signals are used, if the signal phase of PA is ahead of the PB signal, the LSI will count up. The counting direction can be changed using software.
$\overline{PE}x$ $\overline{PE}y$ $\overline{PE}z$ $\overline{PE}u$	45 76 109 140	Input U	Negative	Setting these terminals LOW enables PA/PB and +DR/-DR input. By inputting an axis change switch signal, one manual pulsar can be used alternately for four axes.
+DRx,-DRx +DRy,-DRy +DRz,-DRz +DRu,-DRu	46,47 82,83 110,111 141,142	Input U	Negative #	You can start operation of the PCL with these signals, using external switches. Specifying the feed length, low-speed continuous feed, and high-speed continuous feed are possible. The input logic can be changed using software. The terminal status can be checked using an RSTS command signal (extension status).

Signal name	Terminal No.	Input/output	Logic	Description
PCsx PCSy PCSz PCSu	48 84 112 143	Input U	Negative #	The PCL starts its positioning operation according to this input signal. (Override 2 of the target position.) The input logic can be changed using software. The terminal status can be checked using an RSTS command signal (extension status).
INPx INPy INPz INPu	49 85 113 150	Input U	Negative #	Input the position complete signal from servo driver (in-position signal). Input logic can be changed using software. The terminal status can be checked using an RSTS command signal (extension status).
CLRx CLRy CLRz CLRu	50 86 114 151	Input U	Negative #	Reset a specified counter from COUNTER1 to 4. The input logic can be changed using software. The terminal status can be checked using an RSTS command signal (extension status).
LTCx LTCy LTCz LTCu	51 87 115 152	Input U	Negative #	Latch counter value of specified counters (available on more than one) from COUNTER1 to 4. The input logic can be changed using software. The terminal status can be checked using an RSTS command signal.
ERCx ERCy ERCz ERCu	59 80 124 147	Output	Negative #	Outputs a deflection counter clear signal to a servo driver as a pulse. The output logic and pulse width can be changed using software. A LEVEL signal output is also available. The terminal status can be checked using an RSTS command signal.
\overline{BSYx} \overline{BSYy} \overline{BSYz} \overline{BSYu}	60 81 125 148	Output	Negative	Outputs a LOW signal while feeding.
P0x/FUPx P0y/FUPy P0z/FUPz P0u/FUPu	52 89 116 153	Input/ Output*	Positive	Common terminal for general purpose I/O and FUP. (See Note 5.) As an FUP terminal, it outputs a LOW signal while decelerating As a general purpose I/O terminal, three possibilities can be specified: input terminal, output terminal, and one shot pulse output terminal. The usage, output logic of the FUP and one shot pulse parameters can be changed using software.
P1x/FDWx P1y/FDWy P1z/FDWz P1u/FDWu	53 90 117 154	Input/ Output *	Positive	Common terminal for general purpose I/O and FDW. (See Note 5.) As an FDW terminal, it outputs a LOW signal while decelerating. As a general purpose I/O terminal, three possibilities can be specified: input terminal, output terminal, and one shot pulse output terminal. The usage, output logic of the FDW and one shot pulse parameters can be changed using software.
P2x/MVCx P2y/MVCy P2z/MVCz P2u/MVCu	54 91 118 156	Input/ Output *	Positive	Common terminal for general purpose I/O and MVC. (See Note 5.) When used as an MVC terminal, it outputs a signal while performing a low speed feed. The usage, and output logic of the MVC can be changed using software.
P3x/CP1x (+SLx) P3y/CP1y (+SLy) P3z/CP1z (+SLz) P3u/CP1u (+SLu)	55 92 119 156	Input/ Output *	Positive	Common terminal for general purpose I/O and CP1 (+SL). (See Note 5.) When used as a CP1 (+SL) terminal, it outputs a signal while establishing the conditions (within +SL) of comparator 1. The output logic of CP1 (+SL) as well the selection of input or output functions can be changed using software.

Signal name	Terminal No.	Input/output	Logic	Description
P4x/CP2x (-SLx) P4y/CP2y (-SLy) P4z/CP2z (-SLz) P4u/CP2u (-SLu)	62 93 120 157	Input/ Output *	Positive	Common terminal for general purpose I/O and CP2 (-SL). When used as a CP2 (-SL) terminal, it outputs a signal while establishing the conditions (within -SL) of comparator 2. The output logic of CP2 (-SL) as well as the selection of input or output functions can be changed using software. (See Note 5.)
P5x/CP3x P5y/CP3y P5z/CP3z P5u/CP3u	63 94 126 158	Input/ Output *	Positive	Common terminal for general purpose I/O and CP3. (See Note 5.) When used as a CP3 terminal, it outputs a signal while establishing the conditions of comparator 3. The output logic of CP3 as well as the selection of input or output functions can be changed using software.
P6x/CP4x P6y/CP4y P6z/CP4z P6u/CP4u	64 95 128 159	Input/ Output *	Positive	Common terminal for general purpose I/O and CP4. (See Note 5.) When used as a CP4 terminal, it outputs a signal while establishing the conditions of comparator 4. The output logic of CP4 as well as the selection of input or output functions can be changed using software.
P7x/CP5x P7y/CP5y P7z/CP5z P7u/CP5u	65 96 129 160	Input/ Output *	Positive	Common terminal for general purpose I/O and CP5. (See Note 5.) When used as a CP5 terminal, it outputs a signal while establishing the conditions of comparator 5. The output logic of CP5 as well as the selection of input or output functions can be changed using software.

Note 1: "Input U" refers to an input with a pull up resistor. The internal pull up resistance (50 K to 100 K-ohms) is only used to keep a terminal from floating. If you want to use the LSI with an open collector system, an external pull up resistor (5k to 10 K-ohms) is required.

As a noise prevention measure, pull up unused terminals to VDD5 using an external resistor (5 k to 10 K-ohms), or connect them directly to VDD5.

Note 2: "Input/Output *" refers to a terminal with a pull up resistor. The internal pull up resistor (50 K to 100 K-ohms) is only used to keep a terminal from floating. If it is connected in a wired OR circuit, an external pull up resistor (5 k to 10 K-ohms) is required.

As a noise prevention measure, pull up unused terminals to VDD5 using an external resistor (5 k to 10 K-ohms).

Note 3: If an output terminal is not being used, leave it open.

Note 4: "Positive" refers to positive logic. "Negative" refers to negative logic. "#" means that the logic can be changed using software. "%" means that the logic can be changed by the setting on another terminal. The logic shown refers only to the initial status of the terminal. The DIR terminal is initially in a 2-pulse mode.

Note 5: Use the RENV2 register to select an output signal.

When P0 to P7 are set up as output terminals, they can be controlled simultaneously as 8 bits or one bit at a time using output bit control commands, depending on what is written to the output port (OTP).

When P0 and P1 are set up as one shot pulse output terminals, they will output a one shot signal (T = Approx. 26 msec) using the output bit control command.

Note 6: When a deceleration stop is selected, latch the input signal ON until the PCL stops operation.

5. Block Diagram

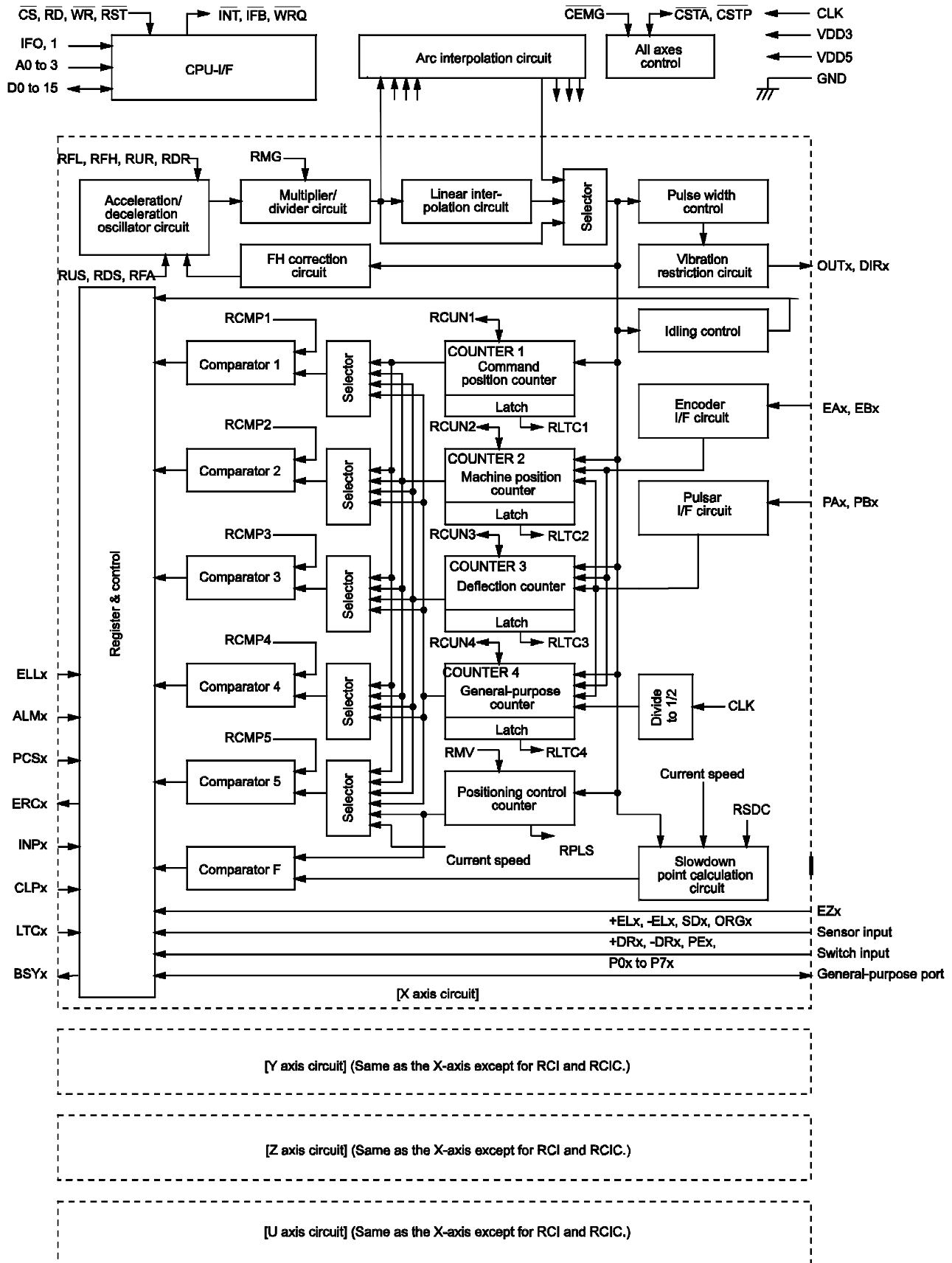

6. CPU Interface

6-1. Setting up connections to a CPU

This LSI can be connected to four types of CPUs by changing the hardware settings.

Use the IF0 and IF1 terminals to change the settings and connect the CPU signal lines as follows.

Setting status		CPU type	CPU signal to connect to the 6045B terminals			
IF1	IF0		RD terminal	WR terminal	A0 terminal	WRQ terminal
L	L	68000	+5V	R/W	CS	DTACK
L	H	H8	RD	HWR	(GND)	WAIT
H	L	8086	RD	WR	(GND)	READY
H	H	Z80	RD	WR	A0	WAIT

6-2. Precautions for designing hardware

- Apply a CMOS level clock to the CLK terminal.
- To reset the LSI, hold the \overline{RST} signal LOW, and input the CLK signal for at least 8-clock cycles.
- Connect unused P0 to P7 terminals to VDD5 through a pull up resistor (5 k to 10 K-ohms).
- When connecting a CPU with an 8-bit bus, pull up terminals D8 to D15 to VDD5 using an external resistor (5 k to 10). (Shared use of one resistor for the 8 lines is available.)
- Use the ELL terminal to change the $\pm EL$ signal input logic.
- To supply and shut down the power, turn both the 5 V and 3.3 V power supplies ON and OFF simultaneously, if possible.
- Turning ON only one power supply may feed current to the other side, which can shorten the life of the LSI if this condition continues over time.

6-3. CPU interface circuit block diagram

1) Z80 interface

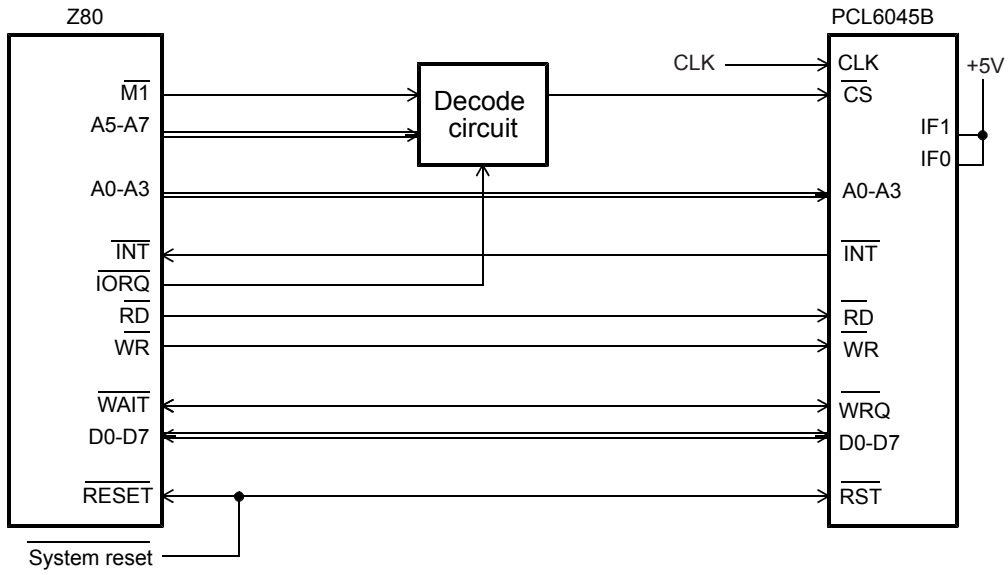

2) 8086 interface

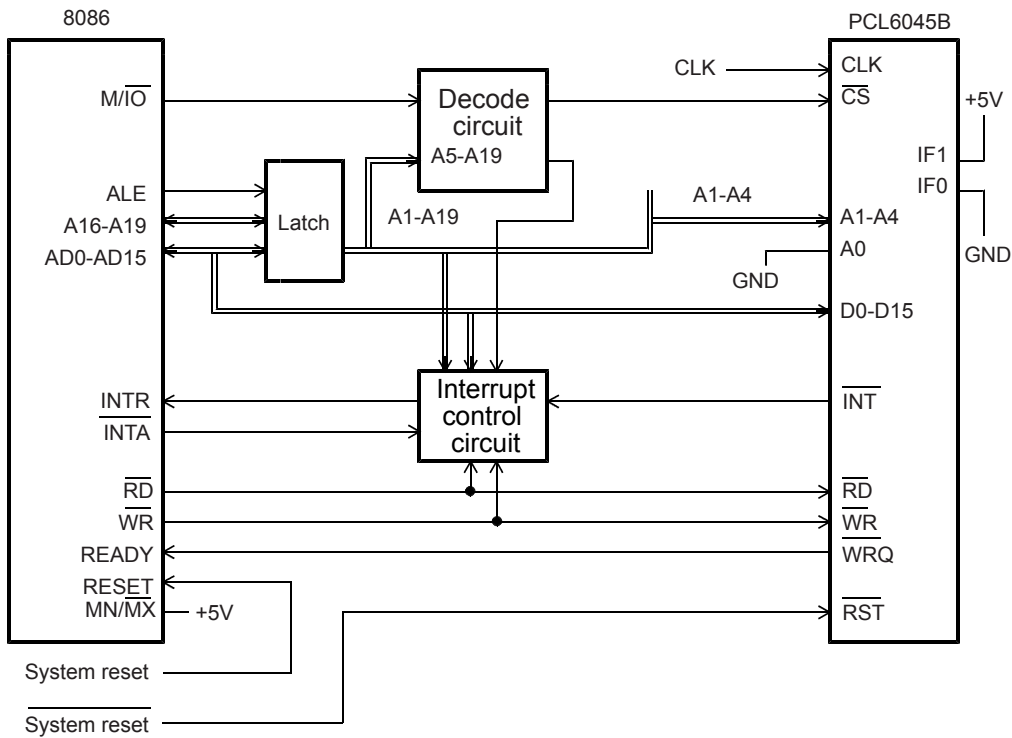

3) H8 interface

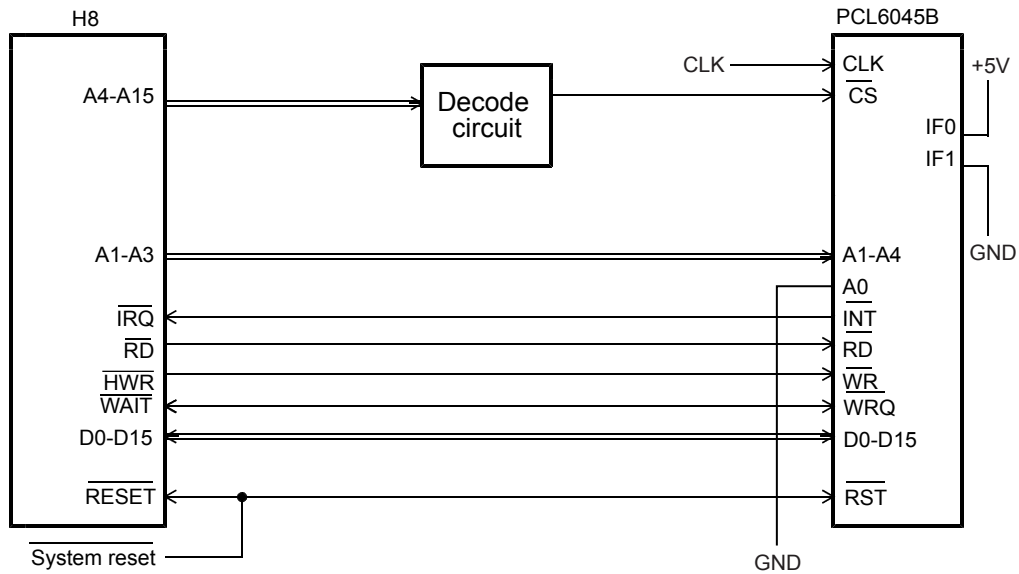

4) 68000 interface

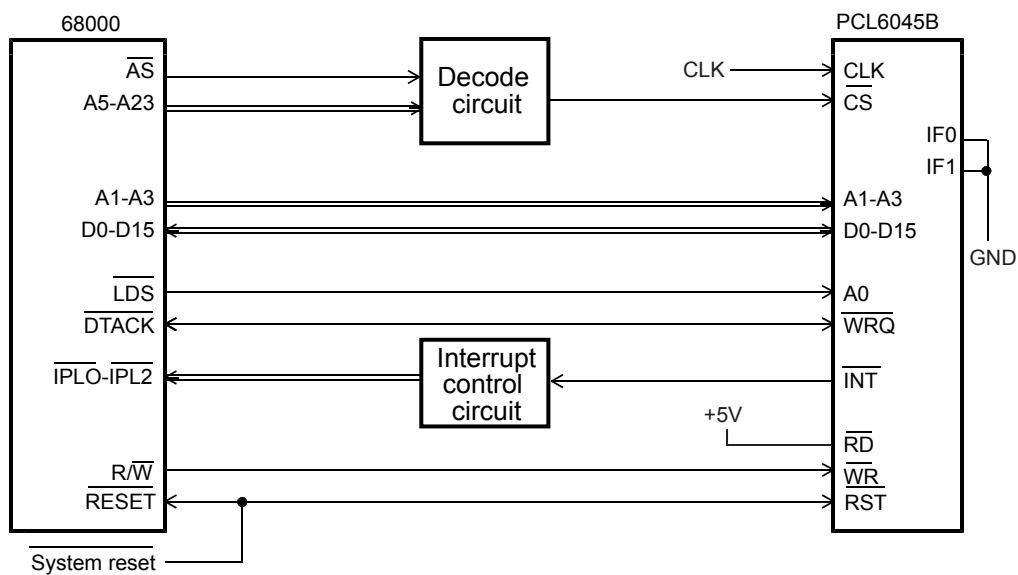

Note: For the 8086, H8, and 68000 interfaces, only word (16-bit) access is available. Byte (8-bit) access is not available.

6-4. Address map

6-4-1. Axis arrangement map

In this LSI, the control address range for each axis is independent. It is selected by using address input terminal A3 and A4, as shown below.

A4	A3	Detail
0	0	X axis control address range
0	1	Y axis control address range
1	0	Z axis control address range
1	1	U axis control address range

6-4-2. Internal map of each axis

The internal map of each axis is defined by A0, A1 and A2 address line inputs.

<When used with the Z80 I/F>

1) Write cycle

A0 to A2	Address signal	Processing detail
000	COMB0	Write a control command
001	COMB1	Assign the axis (specify a control command for execution)
010	OTPB	Change the status of the general-purpose output port (only bits assigned as outputs are effective)
011		(Invalid)
100	BUFB0	Write to the input/output buffer (bits 0 to 7)
101	BUFB1	Write to the input/output buffer (bits 8 to 15)
110	BUFB2	Write to the input/output buffer (bits 16 to 23)
111	BUFB3	Write to the input/output buffer (bits 24 to 31)

2) Read cycle

A0 to A2	Address signal	Processing detail
000	MSTSB0	Read the main status (bits 0 to 7)
001	MSTSB1	Read the main status (bits 8 to 15)
010	IOPB	Read the general-purpose input/output port
011	SSTSB	Read the sub status
100	BUFB0	Read from the input/output buffer (bits 0 to 7)
101	BUFB1	Read from the input/output buffer (bits 8 to 15)
110	BUFB2	Read from the input/output buffer (bits 16 to 23)
111	BUFB3	Read from the input/output buffer (bits 24 to 31)

<When used with the 8086 I/F>

1) Write cycle

A1 to A2	Address signal	Processing detail
00	COMW	Write the axis assignment and control command
01	OTPW	Change the status of the general-purpose output port (only bits assigned as outputs are effective)
10	BUFW0	Write to the input/output buffer (bits 0 to 15)
11	BUFW1	Write to the input/output buffer (bits 16 to 31)

2) Readout cycle

A1 to A2	Address signal	Processing detail
00	MSTSW	Read the main status (bits 0 to 15)
01	SSTSW	Read the sub status or general-purpose input/output port
10	BUFW0	Read from the input/output buffer (bits 0 to 15)
11	BUFW1	Read from the input/output buffer (bits 16 to 31)

<When used with the H8 or 68000 I/F>

1) Write cycle

A1 to A2	Address signal	Processing detail
11	COMW	Write the axis assignment and control command
10	OTPW	Change the status of the general-purpose output port (only bits assigned as outputs are effective)
01	BUFW0	Write to the input/output buffer (bits 0 to 15)
00	BUFW1	Write to the input/output buffer (bits 16 to 31)

2) Readout cycle

A1 to A2	Address signal	Processing detail
11	MSTSW	Read the main status (bits 0 to 15)
10	SSTSW	Read the sub status or general-purpose input/output port
01	BUFW0	Read from the input/output buffer (bits 0 to 15)
00	BUFW1	Read from the input/output buffer (bits 16 to 31)

6-5. Description of the map details

6-5-1. Write the command code and axis selection (COMW, COMB)

Write the commands for reading and writing to registers and the start and stop control commands for each axis.

COMB0: Set the command code. For details, see 7. "Command (Operation and Control commands)."

SELu to x: Select an axis for executing the command. If all of the bits are 0, only this axis (selected by A4, A3) is selected. To write the same command to more than one axis, set the bits of the selected axes to 1. When you write to a register, the details of the input/output buffer are written into the register for each axis. When you read from a register, the details in the register are written into the input/output buffer for each axis.

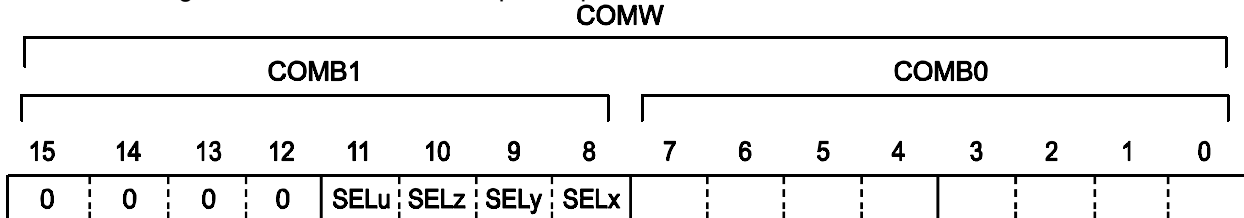

6-5-2. Write to an output port (OTPW, OTPB)

Specify output terminal status from the general purpose I/O terminals P0 to P7.

Bits corresponding to terminals not set as outputs are ignored.

When writing a word, the upper 8 bits are ignored. However, they should be set to 0 for future compatibility.

OTP0 to 7: Specify the status of output terminals P7n to P0n (n = x, y, z, u).

A HIGH is output when the bit is set to 1.

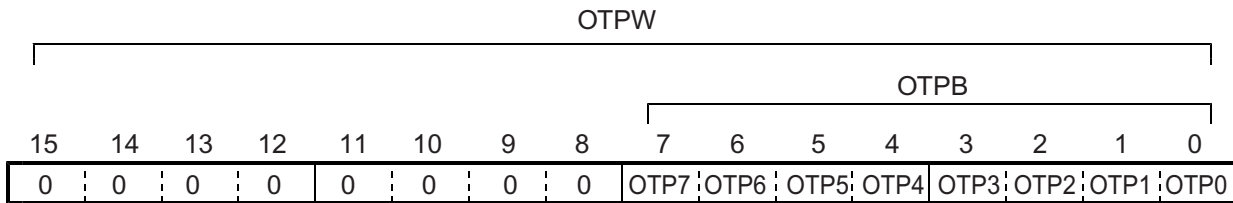

6-5-3. Write/read the input/output buffer (BUFW, BUFB)

When you want to write data into a register, after placing the data in the input/output buffer, write a "register write command" into COMB0. The data in the input/output buffer will be copied into the register. When you want to write data into the input/output buffer, write a "register read command" into COMB0. The data in the register will be copied to the input/output buffer. Then you can read the data from the input/output buffer.

The order for writing and reading buffers BUFW0 to 1 (BUFB0 to 3) is not specified. The data written in the input/output buffer can be read at any time.

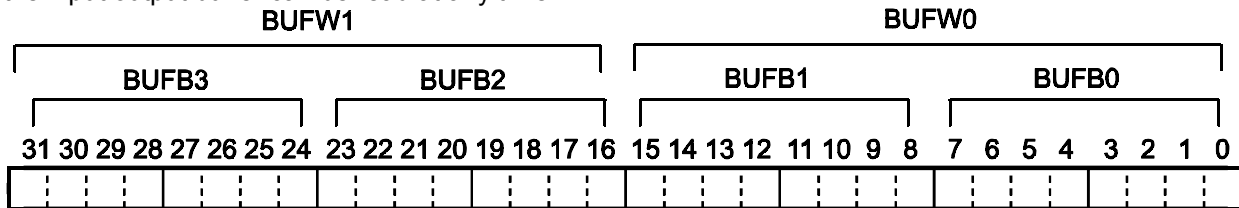

6-5-4. Reading the main status (MSTSW, MSTSB) **MSTSW**

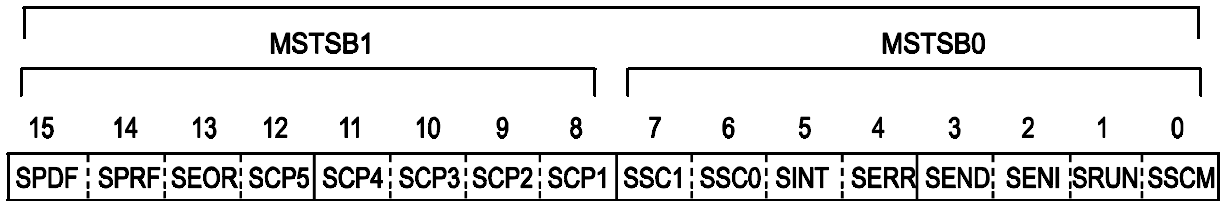

Bit	Bit name	Details
0	SSCM	Set to 1 by writing a start command. Set to 0 when the operation is stopped.
1	SRUN	Set to 1 by the start pulse output. Set to 0 when the operation is stopped.
2	SENI	Stop interrupt flag When IEND in RENV2 is 1, the PCL turns ON the INT output when the status changes from operating to stop, and the SENI bit becomes 1. (After the main status is read, it returns to 0.) When IEND is set to 0, this flag will always be 0.
3	SEND	Set to 0 by writing start command. Set to 1 when the operation is stopped.
4	SERR	Set to 1 when an error interrupt occurs. Set to 0 by reading the RESET.
5	SINT	Set to 1 when an error interrupt occurs. Set to 0 by reading the RIST.
6 to 7	SSC0 to 1	Sequence number for execution or stopping.
8	SCP1	Set to 1 when the COMPARATOR 1 comparison conditions are met.
9	SCP2	Set to 1 when the COMPARATOR 2 comparison conditions are met.
10	SCP3	Set to 1 when the COMPARATOR 3 comparison conditions are met.
11	SCP4	Set to 1 when the COMPARATOR 4 comparison conditions are met.
12	SCP5	Set to 1 when the COMPARATOR 5 comparison conditions are met.
13	SEOR	When a positioning override cannot be executed (reading the RMV register while stopped), this signal changes to 1. After the main status is read, it changes to 0.
14	SPRF	Set to 1 when the pre-register for the subsequent operation data is full.
15	SPDF	Set to 1 when the pre-register for comparator 5 is full.

Status change timing chart

1) When the continuous mode (MOD=00h, 08h) is selected.

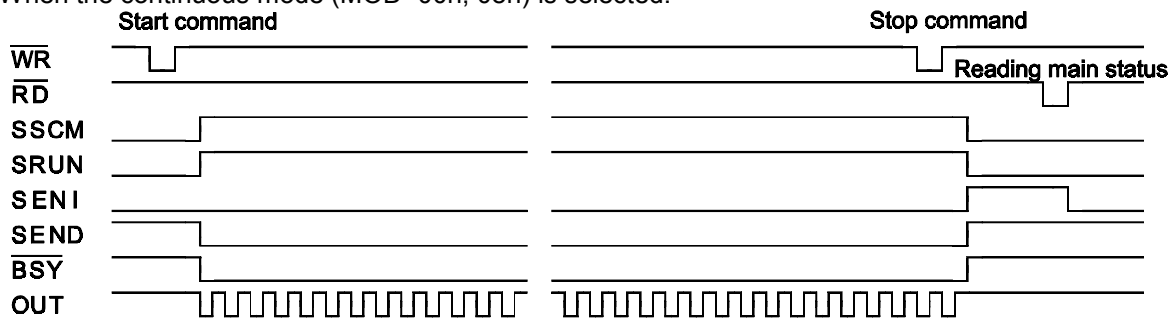

2) When the PA/ PB continuous mode (MOD=01h) is selected.

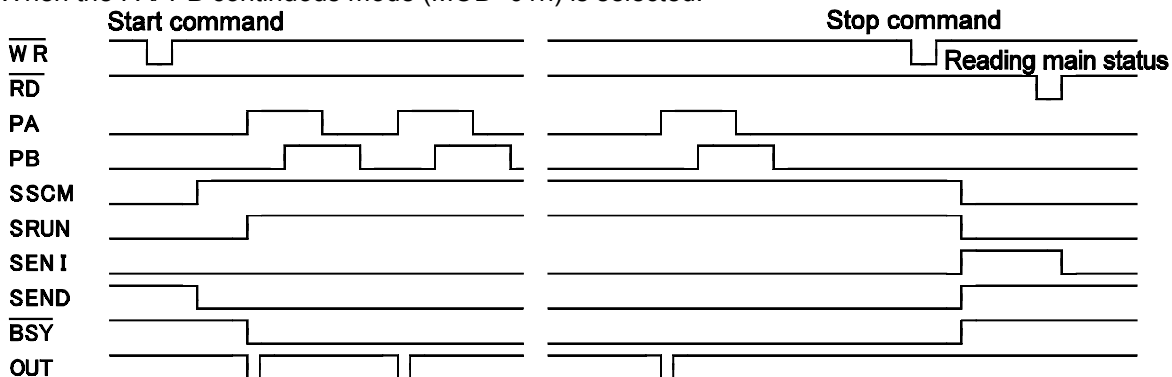

3) When the DR continuous mode (MOD=02h) is selected.

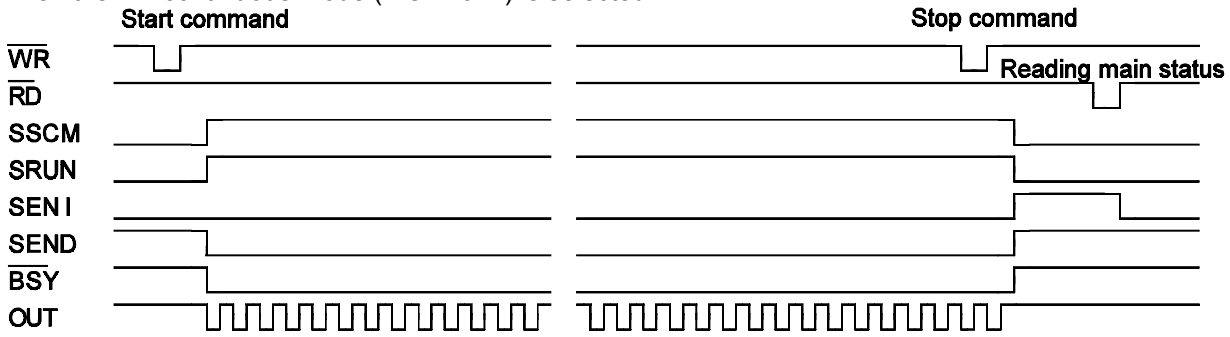

4) When the auto stop mode is selected such as positioning operation mode (MOD=41h).

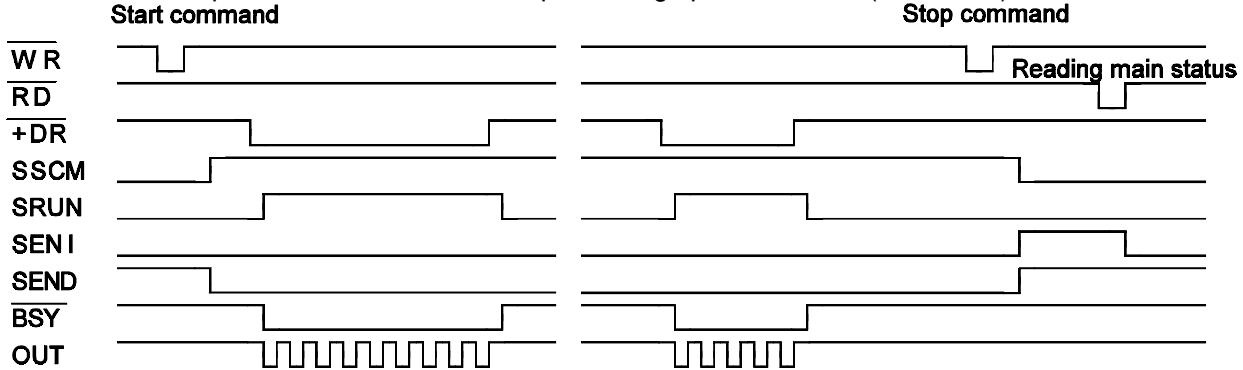

6-5-5. Reading the sub status and input/output port. (SSTSW, SSTSB, IOPB)

SSTSW

SSTSB								IOPB							
15	14	13	12	11	10	9	8	7	6	5	4	3	2	1	0
SSD	SORG	SMEL	SPEL	SALM	SFC	SFD	SFU	IOP7	IOP6	IOP5	IOP4	IOP3	IOP2	IOP1	IOP0
Bit	Bit name	Description													
0 to 7	IOP0 to 7	Read the status of P0 to 7 (0: L level, 1: H level)													
8	SFU	Set to 1 while accelerating.													
9	SFD	Set to 1 while decelerating.													
10	SFC	Set to 1 while feeding at low speed.													
11	SALM	Set to 1 when the ALM input is ON.													
12	SPEL	Set to 1 when the +EL input is ON.													
13	SMEL	Set to 1 when the -EL input is ON.													
14	SORG	Set to 1 when the ORG input is ON.													
15	SSD	Set to 1 when the SD input is ON. (Latches the SD signal.)													

Note: When the backlash or slip correction function is used, SFU, SFD, and SFC will all be 0. The main status SRUM will be 1, even if this correction is used.

7. Commands (Operation and Control Commands)

7-1. Operation commands

After writing the axis assignment data to COMB1 (address 1 when a Z80 I/F is used), write the command to COMB0 (address 0 when a Z80 I/F is used), the LSI will start and stop, as well as change the speed of the output pulses.

When an 8086, H8, or 68000 I/F is used, write 16-bit data, which combines the axis assignment and operation command data.

7-1-1. Procedure for writing an operation command (the axis assignment is omitted)

Write a command to COMB0 (address 0 when a Z80 I/F is used). A waiting time of 4 register reference clock cycles (approximately 0.2 μ sec when CLK = 19.6608 MHz) is required for the interval between "writing a command" and "writing the next command," "writing a register" and "writing the I/O buffer," and between "reading a register" and "reading the I/O buffer." When the WRQ output signal is used by connecting it to the CPU, the CPU automatically ensures this waiting time.

If you want to use a CPU that does not have this waiting function, arrange the program sequence so that access is only allowed after confirming that the IFB output signal is HIGH.

1) When not using \overline{WRQ}

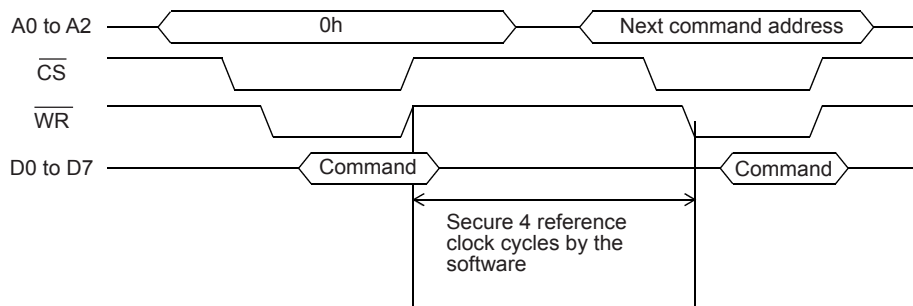

2) When not using \overline{WRQ}

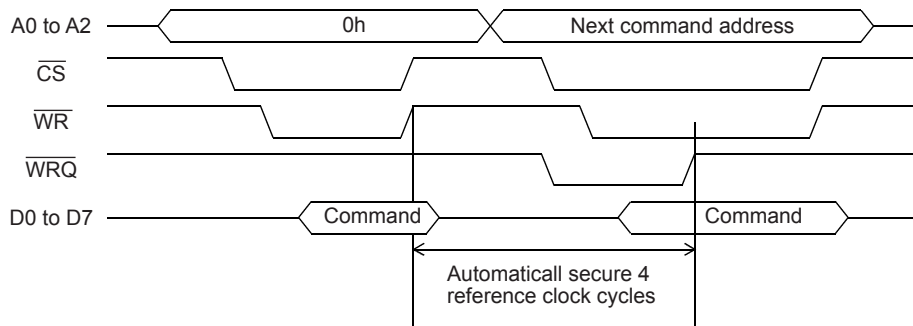

7-1-2. Start command

1) Start command

If this command is written while stopped, the motor will start rotating. If this command is written while the motor is operating, it is taken as the next start command.

COMB0	Symbol	Description
50h	STAFL	FL low speed start
51h	STAFH	FH low speed start
52h	STAD	High speed start 1 (FH low speed -> deceleration stop) Note. 1
53h	STAUD	High speed start 2 (Acceleration -> FH low speed -> Deceleration stop) Note. 1

Note 1: For details, see section 10-1, "Speed patterns."

2) Residual pulses start command

Write this command after the motor is stopped on the way to a positioning, it will continue movement for the number of pulses left in the deflection counter.

COMB0	Symbol	Description
54h	CNTFL	Residual pulses FL low speed start
55h	CNTFH	Residual pulses FH low speed start
56h	CNTD	Residual pulses high speed start (FH constant speed start without acceleration, with deceleration)
57h	CNTUD	Residual pulse high speed start (With acceleration and deceleration.)

3) Simultaneous start command

By setting the RMD register, the LSI will start an axis which is waiting for $\overline{\text{CSTA}}$ signal.

COMB0	Symbol	Description
06h	CMSTA	Output one shot of the start pulse from the $\overline{\text{CSTA}}$ terminal.
2Ah	SPSTA	Only this axis will process the command, the same as when the $\overline{\text{CSTA}}$ signal is input.

7-1-3. Speed change command

Write this command while the motor is operating, the motor on that axis will change its feed speed. If this command is written while stopped it will be ignored.

COMB0	Symbol	Description
40h	FCHGL	Change to the FL speed immediately.
41h	FCHGH	Change to the FH speed immediately.
42h	FSCHL	Decelerate and change to the FL speed.
43h	FSCHH	Accelerate and change to the FH speed.

7-1-4. Stop command

1) Stop command

Write this command to stop feeding while operating.

COMB0	Symbol	Description
49h	STOP	Write this command while in operation to stop immediately.
4Ah	SDSTP	Write this command while feeding at FH low speed or high speed, the motor on that axis will decelerate to the FL low speed and stop. If this command is written while the axis is being fed at FL low speed, the motor on that axis will stop immediately.

2) Simultaneous stop command

Stop the motor on any axis whose $\overline{\text{CSTP}}$ input stop function has been enabled by setting the RMD register.

COMB0	Symbol	Description
07h	CMSTP	Outputs one shot of pulses from the $\overline{\text{CSTP}}$ terminal to stop movement on that axis.

3) Emergency stop command

Stops an axis in an emergency

COMB0	Symbol	Description
05h	CMEMG	Emergency stop (same as a $\overline{\text{CEMG}}$ signal input)

7-1-5. NOP (do nothing) command

COMB0	Symbol	Description
00h	NOP	This command does not affect the operation.

7-2. General-purpose output bit control commands

These commands control the individual bits of output terminals P0 to P7.

When the terminals are designated as outputs, the LSI will output signals from terminals P0 to P7.

Commands that have not been designated as outputs are ignored.

The write procedures are the same as for the Operation commands.

In addition to this command, by writing to a general-purpose output port (OTPB: Address 2 when a Z80 I/F is used), you can set 8 bits as a group. See section 7-5, "General-purpose output port control."

COMB0	Symbol	Description	COMB0	Symbol	Description
10h	P0RST	Make P0 LOW.	18h	P0SET	Make P0 HIGH.
11h	P1RST	Make P1 LOW.	19h	P1SET	Make P1 HIGH.
12h	P2RST	Make P2 LOW.	1Ah	P2SET	Make P2 HIGH.
13h	P3RST	Make P3 LOW.	1Bh	P3SET	Make P3 HIGH.
14h	P4RST	Make P4 LOW.	1Ch	P4SET	Make P4 HIGH.
15h	P5RST	Make P5 LOW.	1Dh	P5SET	Make P5 HIGH.
16h	P6RST	Make P6 LOW.	1Eh	P6SET	Make P6 HIGH.
17h	P7RST	Make P7 LOW.	1Fh	P7SET	Make P7 HIGH.

The P0 and P1 terminals can be set for one shot output (T = approx. 26 msec.) using the RENV2 (Environment setting 2) register, and the output logic can be selected.

To use them as one shot outputs, set the P0 terminal to P0M (bits 0 and 1) = 11, or, set the P1 terminal to P1M (bits 2 and 3) = 11. To change the output logic, set P0L (bit 16) on the P0 terminal and P1L (bit 17) on the P1 terminal.

In order to perform a one-shot output from the P0 and P1 terminals, a bit control command should be written. However, the command you need to write will vary, depending on the output logic selected. See the table below for the details.

Terminal	Logic setting	Bit control command	Terminal	Logic setting	Bit control command
P0	Negative logic (P0L = 0)	P0RST (10h)	P1	Negative logic (P1L = 0)	P1RST (11h)
	Positive logic (P0L = 1)	P0SET (18h)		Negative logic (P1L = 1)	P1SET (19h)

When writing control commands to output ports (OTPB: address 2 for the Z80 interface), the P0 and P1 terminals will not change.

7-3. Control command

Set various controls, such as the reset counter.

The procedures for writing are the same as the operation commands.

7-3-1. Software reset command

Used to reset this LSI.

COMB0	Symbol	Description
04h	SRST	Software reset. (Same function as making the $\overline{\text{RST}}$ terminal LOW.)

7-3-2. Counter reset command

Reset counters to zero.

COMB0	Symbol	Description
20h	CUN1R	Reset COUNTER1 (command position).
21h	CUN2R	Reset COUNTER2 (mechanical position).
22h	CUN3R	Reset COUNTER3 (deflection counter).
23h	CUN4R	Reset COUNTER4 (general-purpose counter).

7-3-3. ERC output control command

Control the ERC signal using commands.

COMB0	Symbol	Description
24h	ERCOUT	Outputs the ERC signal.
25h	ERCRST	Resets the output when the ERC signal output is specified to a level type output.

7-3-4. Pre-register control command

Cancel the pre-register settings and transfer the pre-register data to a register.

See section "8-2. Pre-register" in this manual for details about the pre-register.

COMB0	Symbol	Description
26h	PRECAN	Cancel the operation pre-register. Note 1, 2.
27h	PCPCAN	Cancel the RCMP5 operation pre-register (PRCP5).
2Bh	PRESHF	Shift the operation pre-register data. Note 3.
2Ch	PCPSHF	Shift the RCMP5 operation pre-register data.
4Fh	PRSET	Use the pre-register operation for speed pattern change data using a comparator.

7-3-5. PCS input command

Entering this command has the same results as inputting a signal on the PCS terminal.

COMB0	Symbol	Description
28h	STAON	Alternative to a PCS terminal input.

7-3-6. LTCH input (counter latch) command

Entering this command has the same result as inputting a signal on the LTC terminal.

COMB0	Symbol	Description
29h	LTCH	Alternative to an LTC (latch counter) terminal input.

7-4. Register control command

By writing a Register Control command to COMB0 (Address 0 when a Z80 I/F is used), the LSI can copy data between a register and the I/O buffer.

When using the I/O buffer while responding to an interrupt, a precaution is required, reading the I/O buffer contents before using it and returning it to its original value after use.

7-4-1. Procedure for writing data to a register (the axis assignment is omitted)

- 1) Write the data that will be written to a register into the I/O buffer (addresses 4 to 7 when a Z80 I/F is used). The order in which the data is written does not matter. However, secure two reference clock cycles between these writings.
- 2) Then, write a "register write command" to COMB0 (address 0 when a Z80 I/F is used).
After writing one set of data, wait at least two cycles (approx. 0.1 μ sec when CLK = 19.6608 MHz) before writing the next set of data. In both case 1) and case 2), when the WRQ output is connected to the CPU, the CPU wait control function will provide the waiting time between write operations automatically.

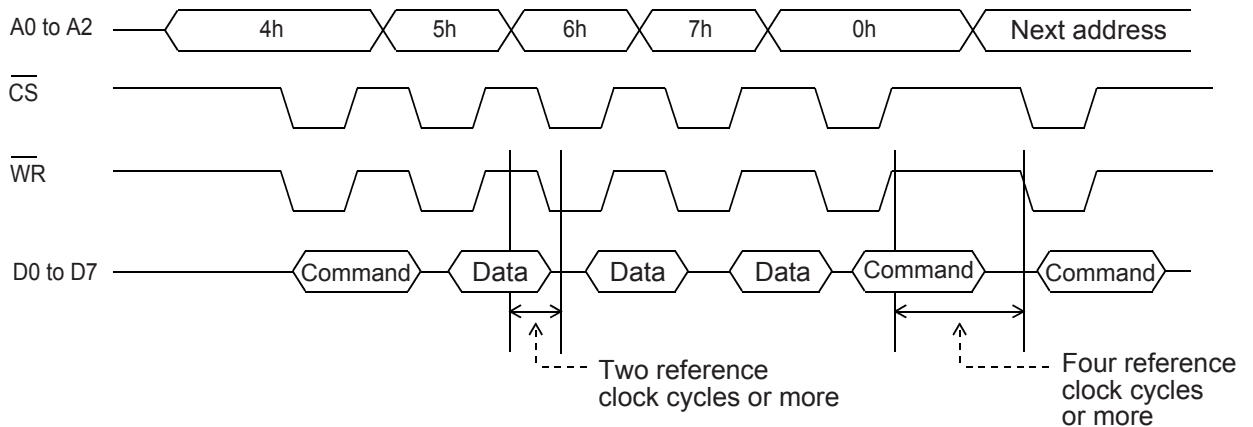

7-4-2. Procedure for reading data from a register (the axis assignment is omitted)

- 1) First, write a "register read out command" to COMB0 (address 0 when a Z80 I/F is used).
- 2) Wait at least four reference clock cycles (approx. 0.2 μ sec when CLK = 19.6608 MHz) for the data to be copied to the I/O buffer.
- 3) Read the data from the I/O buffer (addresses 4 to 7 when a Z80 I/F is used). The order for reading data from the I/O buffer does not matter. There is no minimum time between read operations.

When the WRQ output is connected to the CPU, the CPU wait control function will provide the waiting time between write operations automatically.

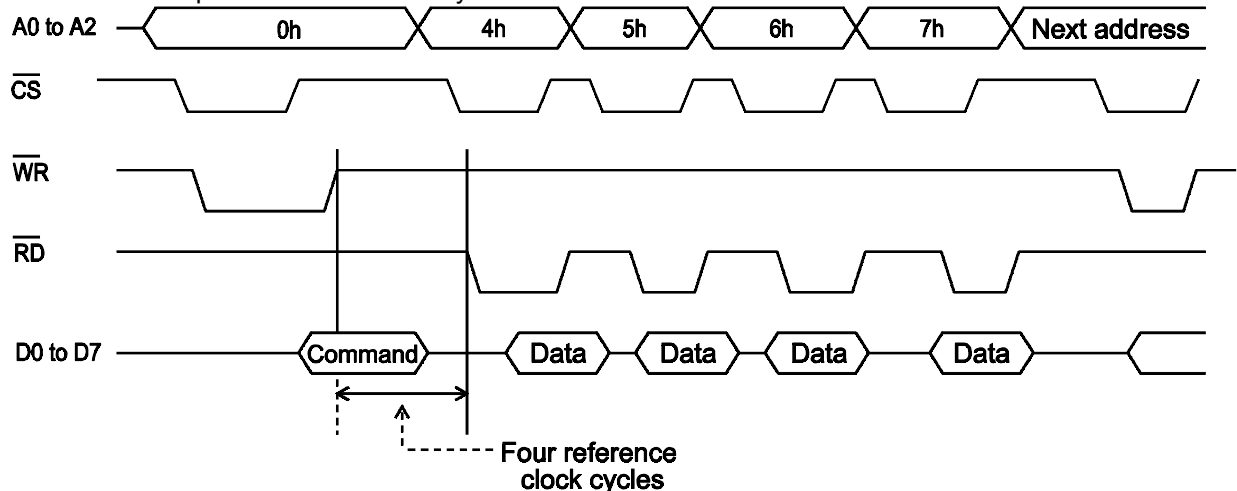

7-4-3. Table of register control commands

No.	Detail	Register					2nd pre-register				
		Name	Read command		Write command		Name	Read command		Write command	
			COMB0	Symbol	COMB0	Symbol		COMB0	Symbol	COMB0	Symbol
1	Feed amount, target position	RMV	D0h	RRMV	90h	WRMV	PRMV	C0h	RPRMV	80h	WPRMV
2	Initial speed	RFL	D1h	RRFL	91h	WRFL	PRFL	C1h	RPRFL	81h	WPRFL
3	Operation speed	RFH	D2h	RRFH	92h	WRFH	PRFH	C2h	RPRFH	82h	WPRFH
4	Acceleration rate	RUR	D3h	RRUR	93h	WRUR	PRUR	C3h	RPRUR	83h	WPRUR
5	Deceleration rate	RDR	D4h	RRDR	94h	WRDR	PRDR	C4h	RPRDR	84h	WPRDR
6	Speed magnification rate	RMG	D5h	RRMG	95h	WRMG	PRMG	C5h	RPRMG	85h	WPRMG
7	Ramping-down point	RDP	D6h	RRDP	96h	WRDP	PRDP	C6h	RPRDP	86h	WPRDP
8	Operation mode	RMD	D7h	RRMD	97h	WRMD	PRMD	C7h	RPRMD	87h	WPRMD
9	Circular interpolation center	RIP	D8h	RRIP	98h	WRIP	PRIP	C8h	RPRIP	88h	WPRIP
10	Acceleration S-curve range	RUS	D9h	RRUS	99h	WRUS	PRUS	C9h	RPRUS	89h	WPRUS
11	Deceleration S-curve range	RDS	DAh	RRDS	9Ah	WRDS	PRDS	CAh	RPRDS	8Ah	WPRDS
12	Feed amount correction speed	RFA	DBh	RRFA	9Bh	WRFA					
13	Environment setting 1	RENV1	DCh	RRENV1	9Ch	WRENV1					
14	Environment setting 2	RENV2	DDh	RRENV2	9Dh	WRENV2					
15	Environment setting 3	RENV3	DEh	RRENV3	9Eh	WRENV3					
16	Environment setting 4	RENV4	DFh	RRENV4	9Fh	WRENV4					
17	Environment setting 5	RENV5	E0h	RRENV5	A0h	WRENV5					
18	Environment setting 6	RENV6	E1h	RRENV6	A1h	WRENV6					
19	Environment setting 7	RENV7	E2h	RRENV7	A2h	WRENV7					
20	COUNTER1 (command position)	RCUN1	E3h	RRCUN1	A3h	WRCUN1					
21	COUNTER2 (mechanical position)	RCUN2	E4h	RRCUN2	A4h	WRCUN2					
22	COUNTER3 (deflection counter)	RCUN3	E5h	RRCUN3	A5h	WRCUN3					
23	COUNTER4 (general purpose)	RCUN4	E6h	RRCUN4	A6h	WRCUN4					
24	Data for comparator 1	RCMP1	E7h	RRCMP1	A7h	WRCMP1					
25	Data for comparator 2	RCMP2	E8h	RRCMP2	A8h	WRCMP2					
26	Data for comparator 3	RCMP3	E9h	RRCMP3	A9h	WRCMP3					
27	Data for comparator 4	RCMP4	EAh	RRCMP4	AAh	WRCMP4					
28	Data for comparator 5	RCMP5	EBh	RRCMP5	ABh	WRCMP5	PRCP5	CBh	RPRCP5	8Bh	WPRCP5
29	Event INT setting	RIRQ	ECh	RRIRQ	ACH	WRIRQ					
30	COUNTER1 latched data	RLTC1	EDh	RRLTC1							
31	COUNTER2 latched data	RLTC2	EEh	RRLTC2							
32	COUNTER3 latched data	RLTC3	EFh	RRLTC3							
33	COUNTER4 latched data	RLTC4	F0h	RRLTC4							
34	Extension status	RSTS	F1h	RRSTS							
35	Error INT status	REST	F2h	RREST							
36	Event INT status	RIST	F3h	RRIST							
37	Positioning counter	RPLS	F4h	RRPLS							
38	EZ counter, speed monitor	RSPD	F5h	RRSPD							
39	Ramping-down point	PSDC	F6h	RPSDC							
40	Circular interpolation stepping number	RCI	FCh	RRCI	BCh	WRCI	PRCI	CCh	RPRCI	8Ch	WPRCI
41	Circular interpolation stepping counter	RCIC	FDh	RRCI							
42	Interpolation status	RIPS	FFh	RRIPS							

7-5. General-purpose output port control command

By writing an output control command to the output port (OTPB: Address 2 when using a Z80 interface), the PCL will control the output of the P0 to P7 terminals.

When the I/O setting for P0 to P7 is set to output, the PCL will output signals from terminals P0 to P7 to issue the command.

When writing words to the port, the upper 8 bits are discarded. However, they should be set to zero to maintain future compatibility.

The output status of terminals P0 to P7 are latched, even after the I/O setting is changed to input. The output status for each terminal can be set individually using the bit control command.

7-5-1. Command writing procedures

Write control data to output port (OTPB: Address 2h when a Z80 I/F is used).

To continue with the next command, the LSI must wait for four reference clock cycles (approx. 0.2 μ sec when CLK = 19.6608 MHz). The \overline{WRQ} terminal outputs a wait request signal.

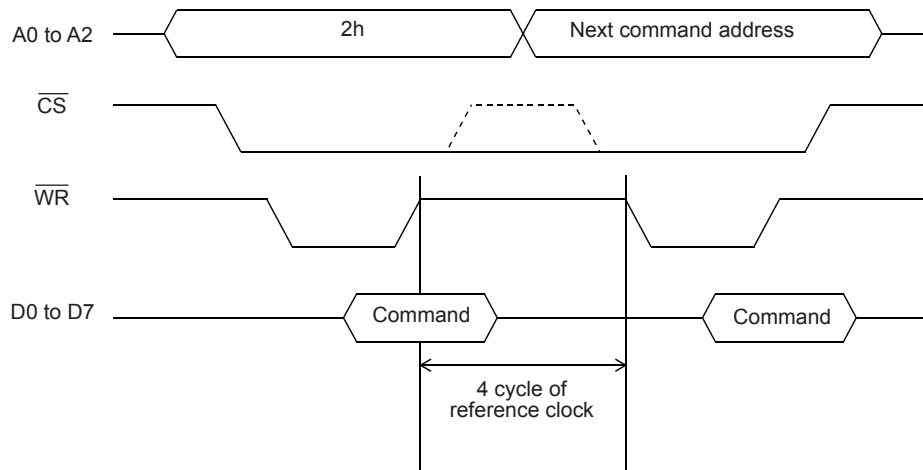

7-5-2. Command bit allocation

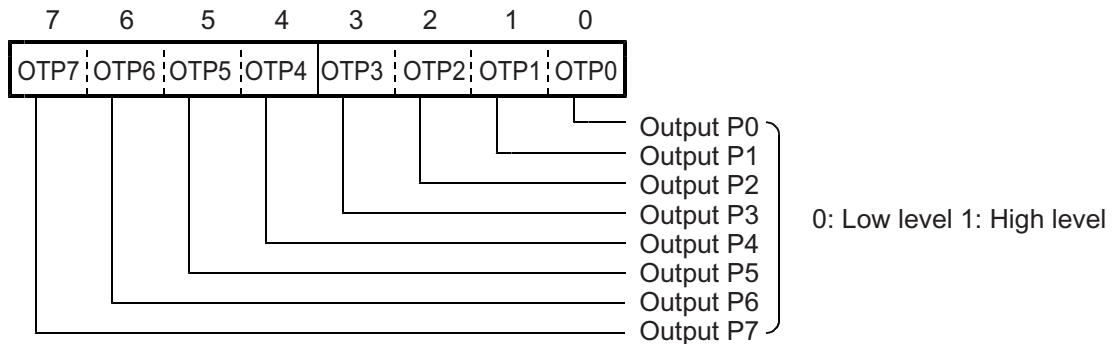

8. Registers

8-1. Table of registers

The following registers are available for each axis.

No.	Register name	Bit length	R/W	Details	2nd pre-register name
1	RMV	28	R/W	Feed amount, target position	PRMV
2	RFL	16	R/W	Initial speed	PRFL
3	RFH	16	R/W	Operation speed	PRFH
4	RUR	16	R/W	Acceleration rate	PRUR
5	RDR	16	R/W	Deceleration rate	PRDR
6	RMG	12	R/W	Speed magnification rate	PRMG
7	RDP	24	R/W	Ramping-down point	PRDP
8	RMD	28	R/W	Operation mode	PRMD
9	RIP	28	R/W	Circular interpolation center position, master axis feed amount with linear interpolation and with multiple chips	PRIP
10	RUS	15	R/W	S-curve acceleration range	PRUS
11	RDS	15	R/W	S-curve deceleration range	PRDS
12	RFA	16	R/W	Speed at amount correction	
13	RENV1	32	R/W	Environment setting 1 (specify I/O terminal details)	
14	RENV2	32	R/W	Environment setting 2 (specify general-purpose port details)	
15	RENV3	32	R/W	Environment setting 3 (specify zero return and counter details)	
16	RENV4	32	R/W	Environment setting 4 (specify details for comparators 1 to 4)	
17	RENV5	22	R/W	Environment setting 5 (specify details for comparator 5)	
18	RENV6	32	R/W	Environment setting 6 (specify details for feed amount correction)	
19	RENV7	32	R/W	Environment setting 7 (specify vibration reduction control details)	
20	RCUN1	28	R/W	COUNTER1 (command position)	
21	RCUN2	28	R/W	COUNTER2 (mechanical position)	
22	RCUN3	16	R/W	COUNTER3 (deflection counter)	
23	RCUN4	28	R/W	COUNTER4 (general-purpose counter)	
24	RCMP1	28	R/W	Comparison data for comparator 1	
25	RCMP2	28	R/W	Comparison data for comparator 2	
26	RCMP3	28	R/W	Comparison data for comparator 3	
27	RCMP4	28	R/W	Comparison data for comparator 4	
28	RCMP5	28	R/W	Comparison data for comparator 5	PRCP5
29	RIRQ	19	R/W	Specify event interruption cause	
30	RLTC1	28	R	COUNTER1 (command position) latch data	
31	RLTC2	28	R	COUNTER2 (mechanical position) latch data	
32	RLTC3	16	R	COUNTER3 (deflection counter) latch data	
33	RLTC4	28	R	COUNTER4 (general-purpose) latch data	
34	RSTS	22	R	Extension status	
35	REST	18	R	Error INT status	
36	RIST	20	R	Event INT status	
37	RPLS	28	R	Positioning counter (number of residual pulses to feed)	
38	RSPD	23	R	EZ counter, current speed monitor	
39	RSDC	24	R	Automatically calculated ramping-down point	
40	RCI	31	R/W	Number of steps for interpolation	PRCI
41	RCIC	31	R	Circular interpolation step counter	
42	RIPS	24	R	Interpolation status	

8-2. Pre-registers

The following registers and start commands have pre-registers:

RMV, RFL, RFH, RUR, RDR, RMG, RDP, RMD, RIP, RUS, RDS, RCI, and RCMP5.

The term pre-register refers to a register which contains the next set of operation data while the current step is executing. This LSI has the following 2-layer structure and executes FIFO operation.

The pre-registers consist of two groups: the operation pre-registers (PRMV, PRFL, PRFH, PRUR, PRDR, PRMG, PRDP, PRMD, PRIP, PRUS, PRDS, PRCI) and the comparator pre-register (PRCP5).

Change

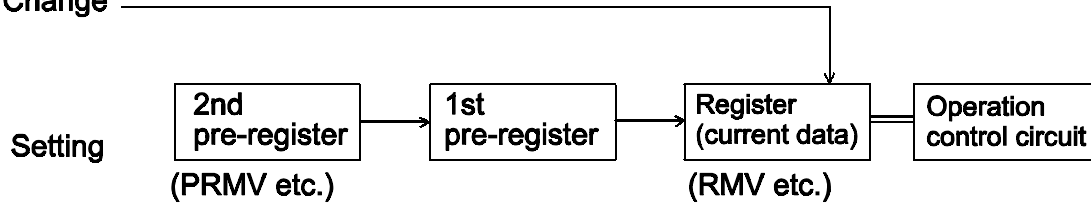

8-2-1. Writing to the operation pre-registers

The pre-registers have a two layer structure and each register can contain up to two pieces of operation data. Write the data to a pre-register (P register name). Registers that don't need to be changed do not need to be rewritten.

When the PCL stops its current operation, the data you wrote to the pre-registers is shifted into the working registers and used as the current data. When the PCL is operating, the data remains stored as pre-register data. The data will be transferred into the pre-registers when a start command is issued.

When the current operation completes, the data will be shifted into the working registers and the PCL starts the new operation automatically. The status of the pre-registers can be checked by reading PFM in the RSET register. When the PFM is value is "11," SPRF in the main status register (MSTSW) changes to "1". Writing data while the pre-register is full is not allowed.

To change the current operating status before the operation is complete, such as when you want to change the speed, write the new data directly to the working register.

The relationship between the write status of the pre-registers and the possible PFM values are as follows.

Procedure	2nd pre-register	1st pre-register	Working register	PFM	SPRF
Initial status	0 Undetermined	0 Undetermined	0 Undetermined	00	0
Write Operation Data 1	Data 1 is undetermined	Data 1 is undetermined	Data 1 is undetermined	00	0
Write a Start command	Data 1 is undetermined	Data 1 is undetermined	Data 1 is set	01	0
Write Operation Data 2 and a Start command while in operation	Data 2 is undetermined	Data 2 is set	Data 1 is set	10	0
Write Operation Data 3 and Start command while in operation	Data 3 is set	Data 3 is set	Data 1 is set	11	1
The operation using Operation Data 1 is complete	Data 3 is undetermined	Data 3 is set	Data 2 is set	10	0

Also, by setting an event interrupt cause in the RIRQ register (IRNM), the PCL can be set to output an **INT** signal as the 2nd pre-register changes from "set" to "undetermined" status when the operation is complete.

Note: When you want the next operation to start automatically using the pre-registers, set the operation completion timing to "cycle completion (METM = 0 on RMD)." When pulse completion (METM = 1 on RMD) is set, the time between the last pulse and next operation start pulse will be as little as $15 \times T_{CLK}$ (T_{CLK} : Reference clock cycle).

For details, see 11-3-2. "Control the output pulse width and operation completion timing."

8-2-2. Cancel the pre-register operations

Use a pre-register Cancel command (26h) and a Stop command (49h, 4Ah) to cancel all the data in the pre-registers, and their status then becomes undetermined. The pre-register data are also cancelled if the PCL stops with an error.

8-2-3. Writing to the comparator pre-registers

Comparator 5 has a pre-register. To overwrite the current data, write directly to RCMP5. To write to the pre-register, write to PRCP5.

The comparator data will only be set by writing to PRCP5. The status of the comparator pre-register can be checked by reading PFC in the RSTS register. When the PFC value is 11, SPDF in the main status register (MSTSW) will be 1. Writing data to the pre-register when it is full is not allowed.

After the conditions have been established, the comparator data in the pre-register will be shifted when the condition changes from false to true.

Comparator data can be written regardless of the PCL mode (stopped/operating).

The relationship between the pre-register writing status and the PFC values are as follows.

Procedure	2nd pre-register	1st pre-register	Working register	PFC	SPDF
Initial status	0 Undetermined	0 Undetermined	0 Undetermined	00	0
Write Data 1 to PRCP5	Data 1 is undetermined	Data 1 is undetermined	Data 1 is set	01	0
Write Data 2 to PRCP5	Data 2 is undetermined	Data 2 is set	Data 1 is set	10	0
Write Data 3 to PRCP5	Data 3 is set	Data 2 is set	Data 1 is set	11	1
Comparison result for Data 1 changes from true to false	Data 3 is undetermined	Data 3 is set	Data 2 is set	10	0

Also, by setting an event interrupt cause in the RIRQ register (IRND), the PCL can be set to output an INT signal as the 2nd pre-register changes from "set" to "undetermined" status when the operation is complete.

8-2-4. Cancel the comparator pre-register data

The pre-register cancel command (27h) will cancel the pre-register data and its status becomes undetermined. However, please note that the register will not change to the undetermined status.

8-3. Description of the registers

The initial value of all the registers and pre-registers is "0."

Please note that with some registers, a value of "0" is outside the allowable setting range.

8-3-1. PRMV (RMV) registers

These registers are used to specify the target position for positioning operations. The set details change with each operation mode.

PMV is the register for PRMV.

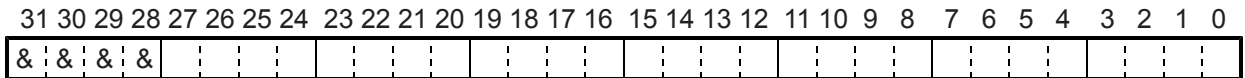

Setting range: -134,217,728 to +134,217,727.

By changing the RMV register while in operation, the feed length can be overridden.

8-3-2. PRFL (RFL) registers

These pre-registers are used to set the initial speed (stop seed) for high speed (with acceleration /deceleration) operations.

RFL is the register for PRFL.

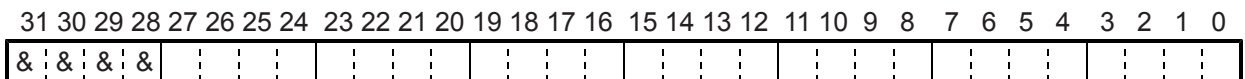

The setting range is 1 to 65,535. However, the actual speed [pps] may vary with the speed magnification rate setting in the PRMG register.

8-3-3. PRFH (RFH) registers

These pre-registers are used to specify the operation speed.

RFH is the working register for PRFH. Write to this register to override the current speed.

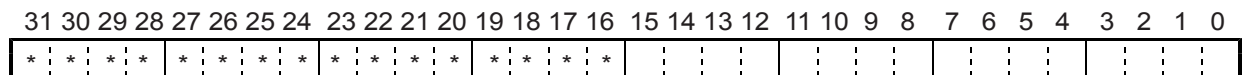

The setting range is 1 to 65,535. However, the actual speed [pps] may vary with the speed magnification rate set in the PRMG register.

8-3-4. PRUR (RUR) registers

These pre-registers are used to specify the acceleration rate.

RUR is the register for PRUR.

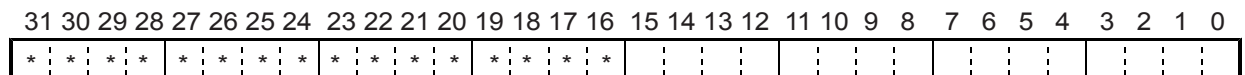

Setting range is 1 to 65,535.

Note 1: Bits marked with an "*" (asterisk) will be ignored when written and are 0 when read.

Note 2: Bits marked with an "&" symbol will be ignored when written and will be the same value as the upper most bit among the non-marked bits. (Sign extension)

8-3-5. PRDR (RDR) registers

These pre-registers are used to specify the deceleration rate.

RDR is the register for PRDR.

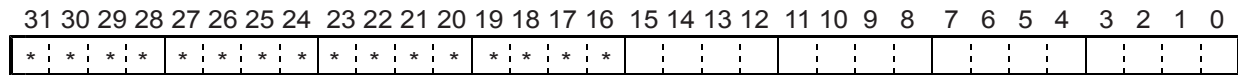

The normal setting range is 1 to 65,535.

When RDR = 0, the deceleration rate will be the value set by PRUR.

8-3-6. PRMG (RMG) registers

These pre-registers are used to set the speed magnification rate.

RMG is the register for PRMG.

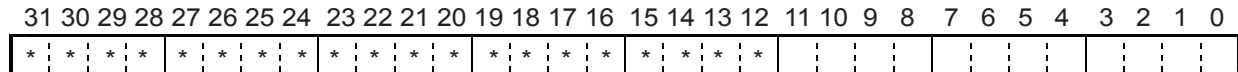

The setting range is 2 to 4,095.

Sets the relationship between the speed register PRFL (RFL), PRFH (RFH), RFA values and the operation speeds.

The actual operation speed [pps] is a product of the speed magnification rate and the speed register setting.

[Setting example when the reference clock is 19.6608 MHz]

Setting	Speed magnification rate	Operation speed setting range [pps]	Setting	Speed magnification rate	Operation speed setting range [pps]
2999	0.1x	0.1 to 6,553.5	59	5x	5 to 327,675
1499	0.2x	0.2 to 13,107.0	29	10x	10 to 655,350
599	0.5x	0.5 to 32,767.5	14	20x	20 to 1,310,700
299	1x	1 to 65,535	5	50x	50 to 3,276,750
149	2x	2 to 131,070	2	100x	100 to 6,553,500

8-3-7. PRDP (RDP) registers

These pre-registers are used to set a ramping-down point (deceleration start point) for positioning operations.

RDP is the 2nd register for PRDP.

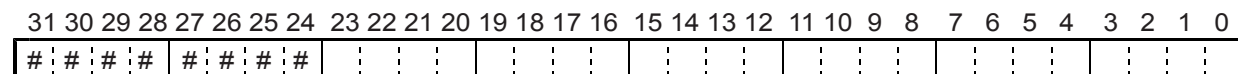

Bits marked with a "#" symbol are ignored when written and change their setting when read according to the setting of MSDP (bit 13) in the PRMD register.

MSDP	Setting details	bit #
0	Offset for automatically set values. When a positive value is entered, the PCL will start deceleration earlier and the FL speed range will be used longer. When a negative value is entered, the PCL will start deceleration later and will not reach the FL speed.	Same as bit 23.
1	When number of pulses left drops to less than a set value, the motor on that axis starts to decelerate.	0

Note 1: Bits marked with an "*" (asterisk) will be ignored when written and are 0 when read.
 Note 2: Bits marked with an "&" symbol will be ignored when written and will be the same value as the upper most bit among the non-marked bits. (Sign extension.)

8-3-8. PRMD (RMD) registers

These pre-registers are used to set the operation mode.

RMD is the register for PRMD.

15	14	13	12	11	10	9	8	7	6	5	4	3	2	1	0
MIPF	MPCS	MSDP	METM	MOCE	MSMD	MINP	MSDE	MENI				MOD			
31	30	29	28	27	26	25	24	23	22	21	20	19	18	17	16
0	0	0	0	MPIE	MADJ	MSPO	MSPE	MAX3	MAX2	MAX2	MAX1	MSY1	MSY0	MSN1	MSN0

Bits	Bit name	Description
Setting basic operation mode		
0 to 6	MOD	<p>Set operation mode.</p> <p>000 0000 (00h): Continuous positive rotation controlled by command control. 000 1000 (08h): Continuous negative rotation controlled by command control. 000 0001 (01h): Continuous operation controlled by pulsar (PA/PB) input. 000 0010 (02h): Continuous operation controlled by external signal (+DR/-DR) input.</p> <p>001 0000 (10h): Positive rotation zero return operation. 001 1000 (18h): Negative rotation zero return operation. 001 0010 (12h): Positive feed leaving from the zero position. 001 1010 (1Ah): Negative feed leaving from the zero position. 001 0101 (15h): Zero search in the positive direction 001 1101 (1Dh): Zero search in the negative direction</p> <p>010 0000 (20h): Feed to +EL or +SL position. 010 1000 (28h): Feed to -EL or -SL position. 010 0010 (22h): Move away from the -EL or -SL position. 010 1010 (2Ah): Move away from the +EL or +SL position. 010 0100 (24h): Feed in the positive direction for a specified number of EZ counts. 010 1100 (2Ch): Feed in the negative direction for a specified number of EZ counts.</p> <p>100 0001 (41h): Positioning operation (specify the incremental target position) 100 0010 (42h): Positioning operation (specify the absolute position in COUNTER1) 100 0010 (43h): Positioning operation (specify the absolute position in COUNTER2) 100 0100 (44h): Zero return of command position (COUNTER1). 100 0101 (45h): Zero return of mechanical position (COUNTER2). 100 0110 (46h): Single pulse operation in the positive direction. 100 1110 (4Eh): Single pulse operation in the negative direction. 100 0111 (47h): Timer operation</p> <p>101 0001 (51h): Positioning operation controlled by pulsar (PA/PB) input. 101 0010 (52h): Positioning operation is synchronized with PA/PB (specify the absolute position of COUNTER1) 101 0011 (53h): Positioning operation is synchronized with PA/PB (specify the absolute position of COUNTER2 101 0100 (54h): Zero return to the specified position controlled by pulsar (PA/PB) input. 101 0101 (55h): Zero return to a mechanical position controlled by pulsar (PA/PB) input. 101 0110 (56h): Positioning operation controlled by external signal (+DR/-DR) input.</p> <p>110 0000 (60h): Continuous linear interpolation 1 (continuous operation with linear interpolation 1) 110 0001 (61h): Linear interpolation 1 110 0010 (62h): Continuous linear interpolation 2 (continuous operation with linear interpolation 2) 110 0011 (63h): Linear interpolation 2 110 0100 (64h): CW circular interpolation operation 110 0101 (65h): CCW circular interpolation operation.</p> <p>110 0110 (66h): Clockwise circular interpolation, synchronized with the U axis (arc linear interpolation) 110 0111 (67h): Counter-clockwise circular interpolation, synchronized with the U axis (arc linear interpolation)</p>

Bits	Bit name	Description
0 to 6	MOD	110 1000 (68h): Continuous linear interpolation 1, synchronized with PA/PB 110 1001 (69h): Linear interpolation 1, synchronized with PA/PB 110 1010 (6Ah): Continuous linear interpolation 2, synchronized with PA/PB. 110 1011 (6Bh): Linear interpolation 2, synchronized with PA/PB. 110 1100 (6Ch): Clockwise circular interpolation, synchronized with PA/PB 110 1101 (6Dh): Counter-clockwise circular interpolation, synchronized with PA/PB
7	MENI	1: When the pre-register is set, the PCL will not output an INT signal, even if IEND becomes 1.
Optical setting items		
8	MSDE	0: SD input will be ignored. (Checking can be done with RSTS in sub status) 1: Decelerates (deceleration stop) by turning ON the input.
9	MINP	0: Delay using an INP input will be possible. (Checking can be done with RSTS in sub status) 1: Completes operation by turning ON the INP input.
10	MSMD	Specify an acceleration/deceleration type for high speed feed. (0: Linear accel/decel. 1: S-curve accel/decel.)
11	MCCE	1: Stop COUNTER1 (command position) This is used to move a mechanical part without changing the PLC control position
12	METM	Specify the operation complete timing. (0: End of cycle. 1: End of pulse.) When using the vibration reduction function, select "End of pulse."
13	MSDP	Specify the ramping-down point for high speed feed. (0: Automatic setting. 1: Manual setting.) Effective for positioning operations and linear interpolation feeding.
14	MPCS	1: While in automatic operation, control the number of pulses after the PCS input is turned ON. (Override 2 for the target position.)
15	MIPF	1: Make a constant, synthetic speed while performing interpolation feeding.
16 to 17	MSN0 to 1	When you want to control an operation block, specify a sequence number using 2 bits. By reading the main status (MSTSW), a sequence number currently being executed (SSC0 to 1) can be checked. Setting the sequence number does not affect the operation.
18 to 19	MSY0 to 1	After writing a start command, the LSI will start an axis synchronization operation based on other timing. 00: Start immediately. 01: The PCL starts on a \overline{CSTA} input (or command 06h, 2Ah). 10: Start with an internal synchronous start signal. 11: Start when a specified axis stops moving.
20 to 23	MAX 0 to 3	Specify an axis to check for an operation stop when the value of MSY 0 to 1 is 11. Setting examples 0001: Starts when the X axis stops. 0010: Starts when the Y axis stops. 0100: Starts when the Z axis stops. 1000: Starts when the U axis stops. 0101: Starts when both the X and Z axes stop. 1111: Starts when all axes stop.
24	MSPE	1: Deceleration stop or immediate stop by \overline{CSTP} input. This is used for a simultaneous stop with another axis when this other axis stops with an error.
25	MSPO	1: Outputs a \overline{CSTP} (simultaneous stop) signal when stopping due to an error.
26	MADJ	Specify an FH correction function. (0: ON. 1: OFF.) When S-shaped deceleration is selected (MSMD = 1) and the operation is set to use linear interpolation 1 (MOD = 61h) with a constant synthesized speed control (MIPF = 1), make sure to turn this bit ON.
27	MPIE	1: After the circular interpolation operation is complete, the PCL will draw to the end point automatically.
28 to 31	Not defined	(Always set to 0.)

8-3-9. PRIP (RIP) registers

These pre-registers are used to set the center position for circular interpolation or a master axis feed amount for linear interpolation 2.
RIP is the register for PRIP.

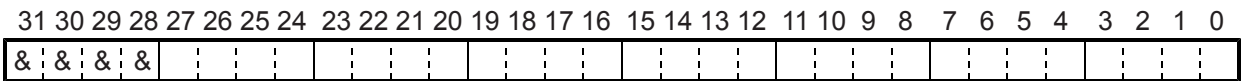

- When MOD (bits 0 to 6) of the PRMD register are set as shown below, the register is enabled.
 - 110 0010 (62h): Continuous linear interpolation 2 (continuous operation with the linear interpolation 2).
 - 110 0011 (63h): Linear interpolation 2.
 - 110 0100 (64h): Circular interpolation in a CW direction.
 - 110 0101 (65h): Circular interpolation in a CCW direction.
- With Continuous linear interpolation 2 and Linear interpolation 2, specify the feed amount on the master axis using an incremental value.
- With circular interpolation, enter a circular center position using an absolute value.
- Setting range: -134,217,727 to +134,217,727

8-3-10. PRUS (RUS) registers

These pre-registers are used to specify the S-curve range of the S-curve acceleration.
RUS is the register for PRUS.

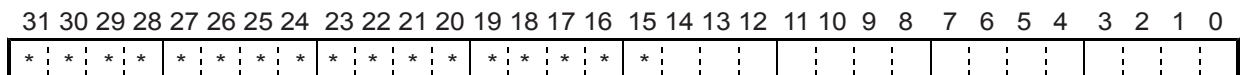

The normal setting range is 1 to 32,767.
When 0 is entered, the value of (PRFH - PRFL)/2 will be calculated internally and applied.

8-3-11. PRDS (RDS) registers

These pre-registers are used to specify the S-curve range of the S-curve deceleration.
RDS is the register for PRDS.

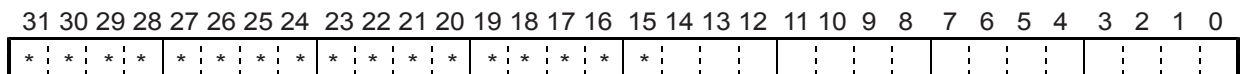

The normal setting range is 1 to 32,767.
When 0 is entered, the value of (PRFH - PRFL)/2 will be calculated internally and applied.

8-3-12. RFA register

This register is used to specify the low speed for backlash correction or slip correction.
This is also used as a reverse low speed for a zero return operation.

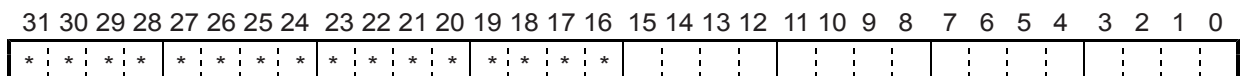

Although the setting range is 1 to 65,535, the actual speed [pps] varies with the speed magnification rate setting in the RMG register.

Note 1: Bits marked with an "*" (asterisk) will be ignored when written and are 0 when read.
Note 2: Bits marked with an "&" symbol will be ignored when written and will be the same value as the upper most bit among the non-marked bits. (Sign extension)

8-3-13. RENV1 register

This register is used for Environment setting 1. This is mainly used to set the specifications for input/output terminals.

15	14	13	12	11	10	9	8	7	6	5	4	3	2	1	0
ERCL	EPW2	EPW1	EPW0	EROR	EROE	ALML	ALMM	ORGL	SDL	SDLT	SDM	ELM	PMD2	PMD1	PMD0
31	30	29	28	27	26	25	24	23	22	21	20	19	18	17	16
PDTC	PCSM	INTM	DTMF	DRF	FLTR	DRL	PCSL	LTCL	INPL	CLR1	CLR0	STPM	STAM	ETW1	ETW0

Bits	Bit name	Description																																																	
0 to 2	PMD0 to 2	Specify OUT output pulse details <table border="1"> <thead> <tr> <th rowspan="2">PMD0 to 2</th><th colspan="2">Positive direction</th><th colspan="2">Negative direction</th></tr> <tr> <th>OUT output</th><th>DIR output</th><th>OUT output</th><th>DIR output</th></tr> </thead> <tbody> <tr> <td>000</td><td></td><td>High</td><td></td><td>Low</td></tr> <tr> <td>001</td><td></td><td>High</td><td></td><td>Low</td></tr> <tr> <td>010</td><td></td><td>Low</td><td></td><td>High</td></tr> <tr> <td>011</td><td></td><td>Low</td><td></td><td>High</td></tr> <tr> <td>100</td><td></td><td>High</td><td>High</td><td></td></tr> <tr> <td>101</td><td></td><td></td><td></td><td></td></tr> <tr> <td>110</td><td></td><td></td><td></td><td></td></tr> <tr> <td>111</td><td></td><td>Low</td><td>Low</td><td></td></tr> </tbody> </table>	PMD0 to 2	Positive direction		Negative direction		OUT output	DIR output	OUT output	DIR output	000		High		Low	001		High		Low	010		Low		High	011		Low		High	100		High	High		101					110					111		Low	Low	
PMD0 to 2	Positive direction			Negative direction																																															
	OUT output	DIR output	OUT output	DIR output																																															
000		High		Low																																															
001		High		Low																																															
010		Low		High																																															
011		Low		High																																															
100		High	High																																																
101																																																			
110																																																			
111		Low	Low																																																
3	ELM	Specify the process to occur when the EL input is turned ON. (0: Immediate stop. 1: Deceleration stop.) Note 1, 2																																																	
4	SDM	Specify the process to occur when the SD input is turned ON. (0: Deceleration only. 1: Deceleration and stop.)																																																	
5	SDLT	Specify the latch function of the SD input. (0: OFF. 1: ON.) Turns ON when the SD signal width is short. When the SD input is OFF while starting, the latch signal is reset. The latch signal is also reset when SDLT is 0.																																																	
6	SDL	Specify the SD signal input logic. (0: Negative logic. 1: Positive logic.)																																																	
7	ORGL	Specify the ORG signal input logic. (0: Negative logic. 1: Positive logic.)																																																	
8	ALMM	Specify the process to occur when the ALM input is turned ON. (0: Immediate stop. 1: Deceleration stop.)																																																	
9	ALML	Specify the ALM signal input logic. (0: Negative logic. 1: Positive logic.)																																																	
10	EROE	1: Automatically outputs an ERC signal when the axis is stopped immediately by a +EL, -EL, ALM, or CEMG input signal. However, the ERC signal is not output when a deceleration stop occurs on the axis. When the EL signal is specified for a normal stop, by setting MOD = "010X000" (feed to the EL position) in the RMD register, the ERC signal is output if an immediate stop occurs.																																																	
11	EROR	1: Automatically output the ERC signal when the axis completes a zero return.																																																	
12 to 14	EPW0 to 2	Specify the pulse width of the ERC output signal. 000: 12 μsec 001: 102 μsec 010: 409 μsec 011: 1.6 msec 100: 13 msec 101: 52 msec 110: 104 msec 111: Level output																																																	
15	ERCL	Specify the ERC signal output logic. (0: Negative logic. 1: Positive logic.)																																																	
16 to 17	ETW0 to 1	Specify the ERC signal OFF timer time. 00: 0 μsec 10: 1.6 msec 01: 12 μsec 11: 104 msec																																																	

Bits	Bit name	Description
18	STAM	Specify the $\overline{\text{CSTA}}$ signal input type. (0: Level trigger. 1: Edge trigger.)
19	STPM	Specify a stop method using $\overline{\text{CSTP}}$ input. (0: Immediate stop. 1: Deceleration stop.) Note 2
20 to 21	CLR0 to 1	Specify a CLR input. 00: Clear on the falling edge 10: Clear on a LOW. 01: Clear on the rising edge 11: Clear on a HIGH.
22	INPL	Specify the INP signal input logic. (0: Negative logic. 1: Positive logic.)
23	LTCL	Specify the operation edge for the LTC signal. (0: Falling. 1: Rising)
24	PCSL	Specify the PCS signal input logic. (0: Negative logic. 1: Positive logic.)
25	DRL	Specify the +DR, -DR signal input logic. (0: Negative logic. 1: Positive logic.)
26	FLTR	1: Apply a filter to the +EL, -EL, SD, ORG, ALM, or INP inputs. When a filter is applied, signal pulses shorter than 4 μsec are ignored.
27	DRF	1: Apply a filter on the +DR, -DR, or PE inputs. When a filter is applied, signals pulses shorter than 32 msec are ignored.
28	DTMF	1: Turn OFF the direction change timer (0.2 msec) function.
29	INTM	1: Mask an INT output. (Changes the interrupt circuit.)
30	PCSM	1: Only allow the PCS input on the local axis $\overline{\text{CSTA}}$ signal.
31	PDTC	1: Keep the pulse width at a 50% duty cycle.

Note1: When a deceleration stop (ELM = 1) has been specified to occur when the EL input turns ON, the axis will start the deceleration when the EL input is turned ON. Therefore, the axis will stop by passing over the EL position. In this case, be careful to avoid collisions of mechanical systems.

Note 2: When deceleration stop is selected, this bit remains ON until the PCL decelerates and stops. The PCL determines whether it has stopped normally or not according to the stop timing. Therefore, if an error stop signal is input while decelerating with high speed positioning, the PCL may determine whether the stop was normal. In this case, the PCL will continue to the next operation without canceling the data stored in the pre-registers. If a constant error stop signal is input, the PCL will not continue to the next operation and it will stop with an error.

8-3-14. RENV2 register

This is a register for the Environment 2 settings. Specify the function of the general-purpose port, EA/EB input, and PA/PB input.

15	14	13	12	11	10	9	8	7	6	5	4	3	2	1	0
P7M1	P7M0	P6M1	P6M0	P5M1	P5M0	P4M1	P4M0	P3M1	P3M0	P2M1	P2M0	P1M1	P1M0	P0M1	P0M0
31	30	29	28	27	26	25	24	23	22	21	20	19	18	17	16
POFF	EOFF	SMAX	PMSK	IEND	PDIR	PIM1	PIM0	EZL	EDIR	EIM1	EIM0	PINF	EINF	P1L	P0L

Bits	Bit name	Description
0 to 1	P0M0 to 1	Specify the operation of the P0/FUP terminals 00: General-purpose input 01: General-purpose output 10: Output the FUP (acceleration) signal. 11: General-purpose one shot signal output (T = 26 msec) Note: 1
2 to 3	P1M0 to 1	Specify the operation of the P1/FDW terminals 00: General-purpose input 01: General-purpose output 10: Output the FDW (deceleration) signal. 11: General-purpose one shot signal output (T = 26 msec) Note: 1
4 to 5	P2M0 to 1	Specify the operation of the P2/MVC terminal. 00: General-purpose input 01: General-purpose output 10: Output the MVC (low speed feeding) signal with negative logic. 11: Output the MVC (low speed feeding) signal with positive logic.
6 to 7	P3M0 to 1	Specify the operation of the P3/CP1 (+SL) terminals. 00: General-purpose input 01: General-purpose output 10: Output the CP1 (satisfied the Comparator 1 conditions) signal with negative logic. 11: Output the CP1 (satisfied the Comparator 1 conditions) signal with positive logic.
8 to 9	P4M0 to 1	Specify the operation of the P4/CP2 (-SL) terminals. 00: General-purpose input 01: General-purpose output 10: Output the CP2 (satisfied the Comparator 2 conditions) signal with negative logic. 11: Output the CP2 (satisfied the Comparator 2 conditions) signal with positive logic.
10 to 11	P5M0 to 1	Specify the operation of the P5/CP3 terminals. 00: General-purpose input 01: General-purpose output 10: Output the CP3 (satisfied the Comparator 3 conditions) signal with negative logic. 11: Output the CP3 (satisfied the Comparator 3 conditions) signal with positive logic.
12 to 13	P6M0 to 1	Specify the operation of the P6/CP4/ID terminals. 00: General-purpose input 01: General-purpose output 10: Output the CP4 (satisfied the Comparator 4 conditions) signal with negative logic. 11: Output the CP4 (satisfied the Comparator 4 conditions) signal with positive logic.
14 to 15	P7M0 to 1	Specify the operation of the P7/CP5 terminals. 00: General-purpose input 01: General-purpose output 10: Output the CP5 (satisfied the Comparator 5 conditions) signal with negative logic. 11: Output the CP5 (satisfied the Comparator 5 conditions) signal with positive logic.
16	P0L	Specify the output logic when the P0 terminal is used for FUP or as a one shot. (0: Negative logic. 1: Positive logic.)
17	P1L	Specify the output logic when the P1 terminal is used for FDW or as a one shot. (0: Negative logic. 1: Positive logic.)
18	EINF	1: Apply a noise filter to EA/EB input. Note 3. Ignores pulse inputs less than 3 CLK signal cycles long.

Bits	Bit name	Description
19	PINF	1: Apply a noise filter to PA/PB input. Note 3. Ignore pulse inputs less than 3 CLK signal cycles long.
20 to 21	EIM0 to 1	Specify the EA/EB input operation. 00: Multiply a 90° phase difference by 1 (Count up when the EA input phase is ahead.) 01: Multiply a 90° phase difference by 2 (Count up when the EA input phase is ahead.) 10: Multiply a 90° phase difference by 4 (Count up when EA input phase is ahead.) 11: Count up when the EA signal rises, count down when the EB signal falls.
22	EDIR	1: Reverse the counting direction of the EA/EB inputs.
23	EZL	Specify EZ signal input logic. (0: Falling edge. 1: Rising edge.)
24 to 25	PIM0 to 1	Specify the PA/PB input operation. 00: Multiply a 90° phase difference by 1 (Count up when the PA input phase is ahead.) 01: Multiply a 90° phase difference by 2 (Count up when the PA input phase is ahead.) 10: Multiply a 90° phase difference by 4 (Count up when PA input phase is ahead.) 11: Count up when the EA signal rises, count down when the PB signal falls.
26	PDIR	1: Reverse the counting direction of the PA/PB inputs.
27	IEND	1: Outputs an INT signal when stopping, regardless of whether the stop was normal or due to an error.
28	PMSK	1: Masks output pulses.
29	SMAX	1: Enable a start operation that is triggered by stop on the same axis.
30	EOFF	1: Disable EA/EB input.
31	POFF	1: Disable PA/PB input.

Note 1: For details about outputting a general-purpose one shot signal, see 7-2 "General-purpose output bit control commands."

8-3-15. RENV3 register

This is a register for the Environment 3 settings. Zero return methods and counter operation specifications are the main function of this register.

15	14	13	12	11	10	9	8	7	6	5	4	3	2	1	0
0	BSYC	CI41	CI40	CI31	CI30	CI21	CI20	EZD3	EZD2	EZD1	EZD0	ORM3	ORM2	ORM1	ORM0
31	30	29	28	27	26	25	24	23	22	21	20	19	18	17	16
CU4H	CU3H	CU2H	0	CU4B	CU3B	CU2B	CU1B	CU4R	CU3R	CU2R	CU1R	CU4C	CU3C	CU2C	CU1C

Bit	Bit name	Description
0 to 3	ORM0 to 3	<p>Specify a zero return method.</p> <p>0000: Zero return operation 0</p> <ul style="list-style-type: none"> - Stops immediately (deceleration stop when feeding at high speed) by changing the ORG input from OFF to ON. - COUNTER reset timing: When the ORG input is turned ON. <p>0001: Zero return operation 1</p> <ul style="list-style-type: none"> - Stops immediately (deceleration stop when feeding at high speed) by changing the ORG input from OFF to ON, and feeds in the opposite direction at RFA low speed until ORG input is turned OFF. Then, feeds in the original direction at RFA speed. While doing so, it will stop immediately when the ORG input is turned ON again. - COUNTER reset timing: When ORG input is turned ON from OFF. <p>0010: Zero return operation 2</p> <ul style="list-style-type: none"> - When feeding at low speed, movement on the axis stops immediately by counting the EZ signal after the ORG input is turned ON. When feeding at high speed, movement on the axis decelerates when the ORG input is turned ON and stops immediately by counting the EZ counts. - COUNTER reset timing: When counting the EZ signal. <p>0011: Zero return operation 3</p> <ul style="list-style-type: none"> - When feeding at low speed, movement on the axis stops immediately by counting the EZ signal after the ORG input is turned ON. When feeding at high speed, the axis will decelerate and stop by counting the EZ signal after the ORG input is turned ON. - COUNTER reset timing: When counting the EZ signal. <p>0100: Zero return operation 4</p> <ul style="list-style-type: none"> - Stops immediately (deceleration stop when feeding at high speed) by turning the ORG input ON, and feeds in the reverse direction at RFA low speed. Stops immediately by counting the EZ signal. - COUNTER reset timing: When counting the EZ signal. <p>0101: Zero return operation 5</p> <ul style="list-style-type: none"> - Stop immediately (deceleration stop when feeding at high speed) and reverse direction when the ORG input is turned ON. Then, stop immediately when counting the EZ signal. - COUNTER reset timing: When counting the EZ signal. <p>0110: Zero return operation 6</p> <ul style="list-style-type: none"> - Stop immediately (deceleration stop when ELM = 1) by turning ON the EL input, and reverse at RFA low speed. Then stop immediately by turning OFF the EL input. - COUNTER reset timing: When EL input is OFF. <p>0111: Zero return operation 7</p> <ul style="list-style-type: none"> - Stop immediately (deceleration stop when ELM = 1) by turning ON the EL input, and reverse direction at RFA low speed. Then stop immediately by counting the EL signal. - COUNTER reset timing: When stopped by counting the EL input. <p>1000: Zero return operation 8</p> <ul style="list-style-type: none"> - Stop immediately (deceleration stop when ELM = 1) and reverse direction by turning ON the EL signal. Then stop immediately (deceleration stop when feeding at high speed) when counting the EZ signal. - COUNTER reset timing: When counting the EZ signal. <p>1001: Zero return operation 9</p> <ul style="list-style-type: none"> - After executing a Zero return operation 0, move back to the zero position (operate until COUNTER2 = 0).

Bit	Bit name	Description
0 to 3	ORM0 to 3	1010: Zero return operation 10 - After executing a Zero return operation 3, move back to the zero position (operate until COUNTER2 = 0). 1011: Zero return operation 11 - After executing a Zero return operation 5, move back to the zero position (operate until COUNTER2 = 0). 1100: Zero return operation 12 - After executing a Zero return operation 8, move back to the zero position (operate until COUNTER2 = 0).
4 to 7	EZD0 to 3	Specify the EZ count up value that is used for zero return operations. 0000 (1st count) to 1111 (16th count)
8 to 9	CI20 to 21	Select the input count source for COUNTER2 (mechanical position). 00: EA/EB input 01: Output pulse 10: PA/PB input
10 to 11	CI30 to 31	Select the input count source for COUNTER3 (deflection counter) 00: Output pulse and EA/EB input (deflection counter) 01: Output pulse and PA/PB input (deflection counter) 10: EA/EB input and PA/PB input (deflection counter)
12 to 13	CI40 to 41	Select the input count source for COUNTER4 (general-purpose) 00: Output pulse 01: EA/EB input 10: PA/PB input 11: Divide the CLK count by 2
14	BSYC	1: Operate COUNTER4 only while LSI is operating (\overline{BSY} is low).
15	Not defined	(Always set to 0.)
16	CU1C	1: Reset COUNTER1 (command position) when the CLR input turns ON.
17	CU2C	1: Reset COUNTER2 (mechanical position) when the CLR input turns ON.
18	CU3C	1: Reset COUNTER3 (deflection counter) when the CLR input turns ON.
19	CU4C	1: Reset COUNTER4 (general-purpose) when the CLR input turns ON.
20	CU1R	1: Reset COUNTER1 (command position) when the zero return is complete.
21	CU2R	1: Reset COUNTER2 (mechanical position) when the zero return is complete.
22	CU3R	1: Reset COUNTER3 (deflection counter) when the zero return is complete.
23	CU4R	1: Reset COUNTER4 (general-purpose) when the zero return is complete.
24	CU1B	1: Operate COUNTER1 (command position) while in backlash/slip correction mode.
25	CU2B	1: Operate COUNTER2 (mechanical position) while in backlash/slip correction mode.
26	CU3B	1: Operate COUNTER3 (deflection counter) while in backlash/slip correction mode.
27	CU4B	1: Operate COUNTER4 (general-purpose) while in backlash/slip correction mode.
28	Not defined	(Always set to 0.)
29	CU2H	1: Stop the counting operation on COUNTER2 (mechanical position). Note 1.
30	CU3H	1: Stop the counting operation on COUNTER3 (deflection counter).
31	CU4H	1: Stop the counting operation on COUNTER4 (general-purpose).

Note 1: To stop the counting on COUNTER1 (command position), change MCCE (bit 11) in the RMD register.

8-3-16. RENV4 register

This register is used for Environment 4 settings. Set up comparators 1 to 4.

15	14	13	12	11	10	9	8	7	6	5	4	3	2	1	0
C2RM	C2D1	C2D0	C2S2	C2S1	C2S0	C2C1	C2C0	C1RM	C1D1	C1D0	C1S2	C1S1	C1S0	C1C1	C1C0
31	30	29	28	27	26	25	24	23	22	21	20	19	18	17	16
C4D1	C4D0	C4S3	C4S2	C4S1	C4S0	C4C1	C4C0	IDXM	C3D1	C3D0	C3S2	C3S1	C3S0	C3C1	C3C0

Bit	Bit name	Description
0 to 1	C1C0 to 1	Select a comparison counter for comparator 1. Note 1 00: COUNTER1 (command position) 01: COUNTER2 (mechanical position) 10: COUNTER3 (deflection counter) 11: COUNTER4 (general-purpose)
2 to 4	C1S0 to 2	Select a comparison method for comparator 1. Note 2 001: RCMP1 data = Comparison counter (regardless of counting direction) 010: RCMP1 data = Comparison counter (while counting up) 011: RCMP1 data = Comparison counter (while counting down) 100: RCMP1 data > Comparison counter data 101: RCMP1 data < Comparison counter data 110: Use as positive end software limit (RCMP1 < COUNTER1) Others: Treats that the comparison conditions are not satisfied. Note 4
5 to 6	C1D0 to 1	Select a process to execute when the Comparator 1 conditions are met. 00: None (use as an \overline{INT} , terminal output, or internal synchronous start) 01: Immediate stop. 10: Deceleration stop. 11: Change operation data to pre-register data (change speed).
7	C1RM	1: Use COUNTER1 for ring counter operation by using Comparator 1. See "11-11-5. Ring counter function."
8 to 9	C2C0 to 1	Select a comparison counter for Comparator 2. Note 1. 00: COUNTER1 (command position) 01: COUNTER2 (mechanical position) 10: COUNTER3 (deflection counter) 11: COUNTER4 (general purpose)
10 to 12	C2S0 to 2	Select a comparison method for Comparator 2. Note 2. 001: RCMP2 data = Comparison counter (regardless of counting direction) 010: RCMP2 data = Comparison counter (while counting up) 011: RCMP2 data = Comparison counter (while counting down) 100: RCMP2 data > Comparison counter data 101: RCMP2 data < Comparison counter data 110: Use as negative end software limit (RCMP2 > COUNTER1) Others: Treats that the comparison conditions do not meet. Note 4.
13 to 14	C2D0 to 1	Select a process to execute when the Comparator 2 conditions are met. 00: None (use as an \overline{INT} , terminal output, or internal synchronous start) 01: Immediate stop. 10: Deceleration stop. 11: Change operation data to pre-register data (change speed).
15	C2RM	1: Use COUNTER2 for ring counter operation by using Comparator 2. See "11-11-5. Ring counter function."
16 to 17	C3C0 to 1	Select a comparison counter for Comparator 3. Note 1 00: COUNTER1 (command position) 01: COUNTER2 (mechanical position) 10: COUNTER3 (deflection counter) 11: COUNTER4 (general-purpose)

18 to 20	C3S0 to 2	Select a comparison method for comparator 3. Note 2 001: RCMP3 data = Comparison counter (regardless of counting direction) 010: RCMP3 data = Comparison counter (while counting up) 011: RCMP3 data = Comparison counter (while counting down) 100: RCMP3 data > Comparison counter data 101: RCMP3 data < Comparison counter data 110: Prohibited setting Others: Treats that the comparison conditions do not meet.
21 to 22	C3D0 to 1	Select a process to execute when the Comparator 3 conditions are met. 00: None (use as an \overline{INT} , terminal output, or internal synchronous start) 01: Immediate stop. 10: Deceleration stop. 11: Change operation data to pre-register data (change speed).
23	IDXM	0: Outputs an IDX signal while COUNTER4 = RCMP2. 1: When COUNTER4 reaches 0 by counting, the PCL outputs an IDX signal for two CLK cycles. (This is only possible when the values in C4S0 to C4S3 are 1000 to 1010.)
24 to 25	C4C0 to 1	Select a comparison counter for Comparator 4. Note 1. 00: COUNTER1 (command position) 01: COUNTER2 (mechanical position) 10: COUNTER3 (deflection counter) 11: COUNTER4 (general purpose)
26 to 29	C4S0 to 3	Select a comparison method for Comparator 4. Note 3. 0001: RCMP4 data = Comparison counter (regardless of counting direction) 0010: RCMP4 data = Comparison counter (while counting up) 0011: RCMP4 data = Comparison counter (while counting down) 0100: RCMP4 data > Comparison counter data 0101: RCMP4 data < Comparison counter data 0111: Treats that the comparison conditions do not meet. 1000: Use as IDX (synchronous) signal output (regardless of counting direction) 1001: Use as IDX (synchronous) signal output (while counting up) 1010: Use as IDX (synchronous) signal output (while counting down) Others: Treats that the comparison conditions do not meet.
30 to 31	C4D0 to 1	Select a process to execute when the Comparator 4 conditions are met. 00: None (use as an \overline{INT} , terminal output, or internal synchronous start) 01: Immediate stop. 10: Deceleration stop. 11: Change operation data to pre-register data (change speed).

Note 1: When COUNTER3 (deflection counter) is selected as the comparison counter, the LSI compares the counted absolute value and the comparator data. (Absolute value range: 0 to 32,767.)

Note 2: When you specify C1S0 to 2 = 110 (positive software limit) or C2S0 to 2 = 110 (negative software limit), select COUNTER1 (specified position) as the comparison counter.

Note 3: When C4S0 to 3 is set to 1000 to 1010 (synchronous signal output), select COUNTER4 (general-purpose) for the comparison counter. The other counters cannot be selected.
To set the comparator, select a positive value.

Note 4: When this bit is used as software limit, the PCL stops operation regardless of the settings for selecting a process when the conditions are satisfied. However, when the PCL is operating and "10: Deceleration stop" is selected, it only uses a deceleration stop when operating at high speed. In all other cases, it stops immediately.

8-3-17. RENV5 register

This is a register for the Environment 5 settings. Settings for Comparator 5 are its main use.

15	14	13	12	11	10	9	8	7	6	5	4	3	2	1	0
LTOF	LTFD	LTM1	LTM0	0	IDL2	IDL1	IDL0	C5D1	C5D0	C5S2	C5S1	C5S0	C5C2	C5C1	C5C0
31	30	29	28	27	26	25	24	23	22	21	20	19	18	17	16
0	0	0	0	0	0	0	0	0	0	SY11	SY10	SYO3	SYO2	SYO1	SYO0

Bit	Bit name	Description
0 to 2	C5C0 to 2	Select a comparison counter for comparator 5. 000: COUNTER1 (command position) 011: COUNTER4 (general-purpose) 001: COUNTER2 (mechanical position) 100: Positioning counter 010: COUNTER3 (deflection counter) 101: Current speed data
3 to 5	C5S0 to 2	Select a comparison method for comparator 5. 001: RCMP5 data = Comparison counter (regardless of counting direction) 010: RCMP5 data = Comparison counter (while counting up) 011: RCMP5 data = Comparison counter (while counting down) 100: RCMP5 data > Comparison counter 101: RCMP5 data < Comparison counter Others: Treats that the comparison conditions are not met.
6 to 7	C5D0 to 1	Select a process to execute when the Comparator 5 conditions are met. 00: None (use as an INT, terminal output, or internal synchronous start) 01: Immediate stop. 10: Deceleration stop. 11: Change operation data to pre-register data (change speed).
8 to 10	IDL0 to 2	Enter the number of idling pulses. (0 to 7 pulses)
11	Not defined	(Always set to 0.)
12 to 13	LTM0 to 1	Specify the latch timing for a counter (COUNTER1 to 4). 00: When the LTC input turns ON. 01: On an ORG input 10: When the Comparator 4 conditions are met. 11: When the Comparator 5 conditions are met.
14	LTFD	1: Latch the current speed in place of COUNTER3.
15	LTOF	1: Stop the latch by timing of a hardware operation. (Only used by software.)
16 to 19	SYO0 to 3	Select the output timing of the internal synchronous signal. 0001: When the Comparator 1 conditions are met. 0010: When the Comparator 2 conditions are met. 0011: When the Comparator 3 conditions are met. 0100: When the Comparator 4 conditions are met. 0101: When the Comparator 5 conditions are met. 1000: When starting acceleration. 1001: When ending acceleration. 1010: When starting deceleration. 1011: When ending deceleration. Others: Internal synchronous signal output is OFF.
20 to 21	SY10 to 1	Select an input source when starting with an internal synchronous signal. 00: Internal synchronous signal output from the X axis. 01: Internal synchronous signal output from the Y axis. 10: Internal synchronous signal output from the Z axis. 11: Internal synchronous signal output from the U axis.
22 to 23	Not defined	(Always set to 0.)
24	CU1L	1: Resets COUNTER1 at the same time COUNTER1 is latched.
25	CU2L	1: Resets COUNTER2 at the same time COUNTER2 is latched.
26	CU3L	1: Resets COUNTER3 at the same time COUNTER3 is latched.
27	CU4L	1: Resets COUNTER4 at the same time COUNTER4 is latched.
28 to 31	Not defined	(Always set to 0.)

8-3-18. RENV6 register

This is a register for the Environment 6 settings. It is primarily used to set feed amount correction data.

15	14	13	12	11	10	9	8	7	6	5	4	3	2	1	0
PSTP	0	ADJ1	ADJ0	BR11	BR10	BR9	BR8	BR7	BR6	BR5	BR4	BR3	BR2	BR1	BR0
31	30	29	28	27	26	25	24	23	22	21	20	19	18	17	16
PMG4	PMG3	PMG2	PMG1	PMG0	PD10	PD9	PD8	PD7	PD6	PD5	PD4	PD3	PD2	PD1	PD0

Bit	Bit name	Description
0 to 11	BR0 to 11	Enter a backlash correction amount or a slip correction amount. (0 to 4095)
12 to 13	ADJ0 to 1	Select a feed amount correction method. 00: Turn OFF the correction function. 01: Backlash correction 10: Slip correction
14	Not defined	(Always set to 0.)
15	PSTP	1: Even if a stop command is written, the PCL will operate for the number of pulses that are already input on PA/PB. Note 1.
16 to 26	PD0 to 10	Specifies the division ratio for pulses on the PA/PB input. The number of pulses are divided using the set value/2048. When 0 is entered, the division circuit will be OFF. (= 2048/2048)
27 to 31	PMG0 to 4	Specifies the magnification rate for pulses on the PA/PB input. The number of pulses are multiplied by the set value + 1.

Note 1: When PSTP is 1, the Stop command will be ignored when $\overline{BSYn} = H$ (OFF), regardless of the operation mode. Before writing a Stop command, check the main status register. When SRUN = 0, change PSTP to 0 and then write a Stop command.

8-3-19. RENV7 register

This is a register for the Environment 7 settings. It is primarily used to enter the time for the vibration reduction function. If both RT and FT data are other than zero, the vibration reduction function is turned ON.

15	14	13	12	11	10	9	8	7	6	5	4	3	2	1	0
RT15	RT14	RT13	RT12	RT11	RT10	RT9	RT8	RT7	RT6	RT5	RT4	RT3	RT2	RT1	RT0
31	30	29	28	27	26	25	24	23	22	21	20	19	18	17	16
FT15	FT14	FT13	FT12	FT11	FT10	FT9	FT8	FT7	FT6	FT5	FT4	FT3	FT2	FT1	FT0

Bit	Bit name	Description
0 to 15	RT0 to 15	Enter the RT time shown in the figure below. The units are 32 ticks of the reference clock (approx. 1.6 μ sec).
16 to 31	FT0 to 15	Enter the FT time shown in the figure below. The units are 32 ticks of the reference clock (approx. 1.6 μ sec).

The dotted lines in the figure below are pulses added by the vibration reduction function.

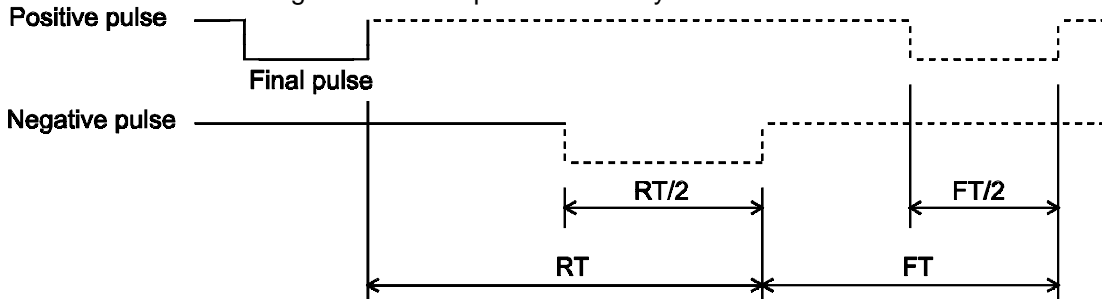

8-3-20. RCUN1 register

This is a register used for COUNTER1 (command position counter).

This is a counter used exclusively for command pulses.

Setting range: -134,217,728 to +134,217,727.

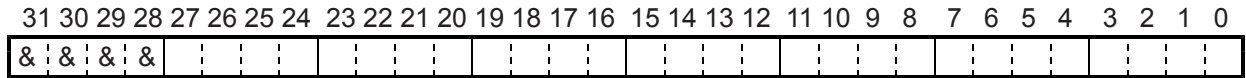

8-3-21. RCUN2 register

This is a register used for COUNTER2 (mechanical position counter).

It can count three types of pulses: Command pulses, encoder signals (EA/EB input), pulsar inputs (PA/PB input).

Setting range: -134,217,728 to +134,217,727.

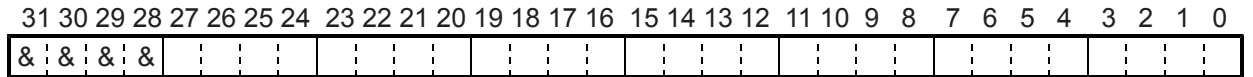

8-3-22. RCUN3 register

This is a register used for COUNTER3 (deflection counter).

It can count three types of deflections: Between command pulses and encoder signals, between command pulses and pulsar signals, and between encoder signals and pulsar signals.

Setting range: -32,768 to +32,767.

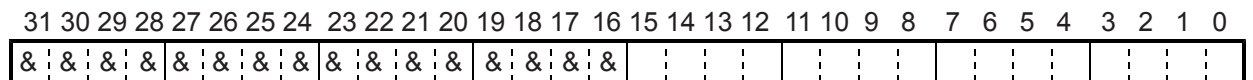

8-3-23. RCUN4 register

This is a register used for COUNTER4 (general-purpose counter).

It can count four types of signals: Command pulses, encoder signals (EA/EB input), pulsar signals (PA/PB input), and 1/2 ticks of the reference clock.

Setting range: -134,217,728 to +134,217,727.

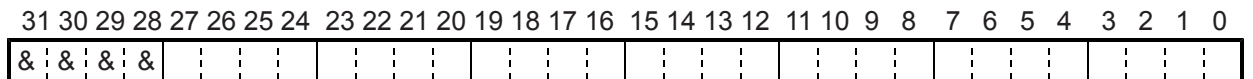

For details about the counters, see section 11-10, "Counters."

<p>Note 1: Bits marked with an "*" (asterisk) will be ignored when written and are 0 when read.</p> <p>Note 2: Bits marked with an "&" symbol will be ignored when written and will be the same value as the upper most bit among bits having no marks when read. (Sign extension)</p>
--

8-3-24. RCMP1 register

Specify the comparison data for Comparator 1.

Setting range: -134,217,728 to +134,217,727.

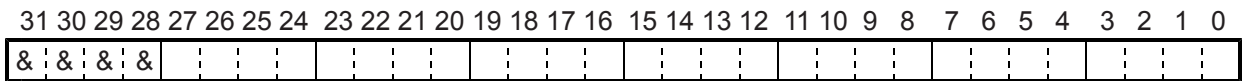

8-3-25. RCMP2 register

Specify the comparison data for Comparator 2.

Setting range: -134,217,728 to +134,217,727.

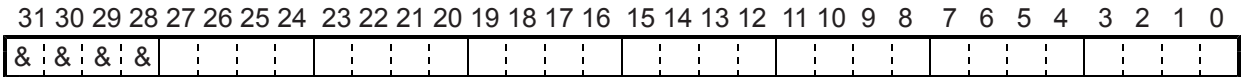

8-3-26. RCMP3 register

Specify the comparison data for Comparator 3.

Setting range: -134,217,728 to +134,217,727.

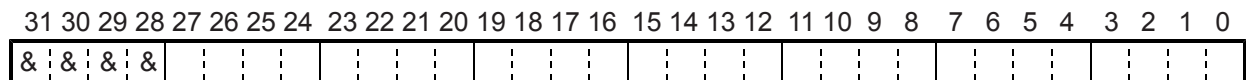

8-3-27. RCMP4 register

Specify the comparison data for Comparator 4.

Setting range: -134,217,728 to +134,217,727.

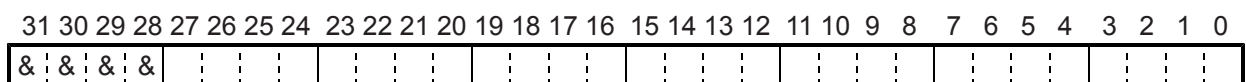

8-3-28. RCMP5 (PRCP5) register

Specify the comparison data for Comparator 5.

PRCP5 is the 2nd pre-register for RCMP5.

Normally, use RCMP5. To use the comparator pre-register function, use PRCP5.

Setting range: -134,217,728 to +134,217,727.

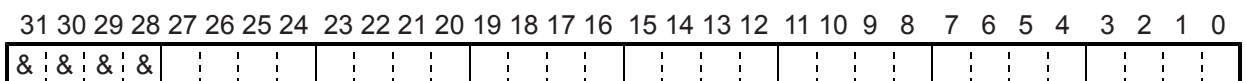

For details about the comparators, see section 11-11, "Comparator."

Note 1: Bits marked with an "*" (asterisk) will be ignored when written and are 0 when read.
Note 2: Bits marked with an "&" symbol will be ignored when written and will be the same value as the upper most bit among bits having no marks when read. (Sign extension)

8-3-29. RIRQ register

Enables event interruption cause.

Bits set to 1 that will enable an event interrupt for that event.

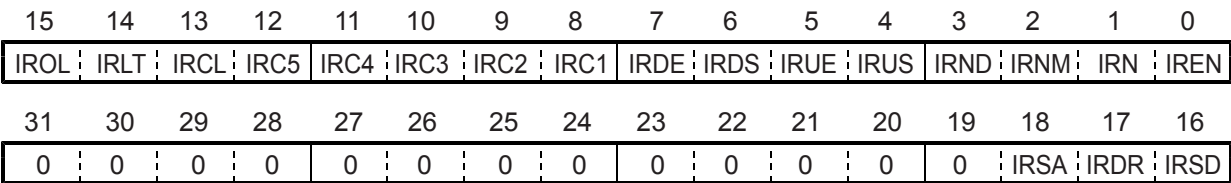

Bit	Bit name	Description
0	IREN	Stopping normally.
1	IRN	Starting the next operation continuously.
2	IRNM	Writing to the 2nd pre-register.
3	IRND	Writing to the 2nd pre-register for Comparator 5.
4	IRUS	Starting acceleration.
5	IRUE	When ending acceleration.
6	IRDS	When starting deceleration.
7	IRDE	When ending deceleration.
8	IRC1	When Comparator 1 conditions are met.
9	IRC2	When Comparator 2 conditions are met.
10	IRC3	When Comparator 3 conditions are met.
11	IRC4	When Comparator 4 conditions are met.
12	IRC5	When Comparator 5 conditions are met.
13	IRCL	When resetting the count value with a CLR signal input.
14	IRLT	When latching the count value with an LTC signal input.
15	IROL	When latching the count value with an ORG signal input.
16	IRSD	When the SD input is ON.
17	IRDR	When the \pm DR input is changed.
18	IRSA	When the \overline{CSTA} input is ON.
19 to 31	Not defined	(Always set to 0.)

8-3-30. RLTC1 register

Latched data for COUNTER1 (command position). (Read only.)

The contents of COUNTER1 are copied when triggered by the LTC, an ORG input, or an LTCH command.

Data range: -134,217,728 to +134,217,727.

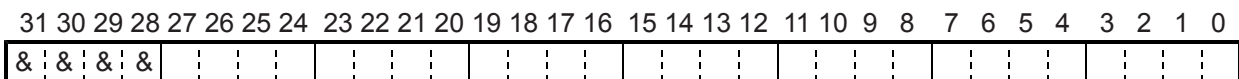

8-3-31. RLTC2 register

Latched data for COUNTER2 (mechanical position). (Read only.)

The contents of COUNTER2 are copied when triggered by the LTC, an ORG input, or an LTCH command.

Data range: -134,217,728 to +134,217,727.

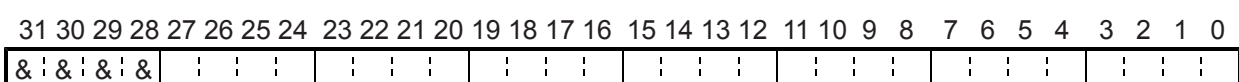

8-3-32. RLTC3 register

Latched data for COUNTER3 (deflection counter) or current speed. (Read only.)

The contents of COUNTER3 or the current speed are copied when triggered by the LTC, an ORG input, or an LTCH command. When the LTFD in the RENV5 register is 0, the register latches the COUNTER3 data. When the LTFD is 1, the register latches the current speed. When the LTFD is 1 and movement on the axis is stopped, the latched data will be 0.

Data range when LTFD is 0: -32,768 to +32,767.

Data range when LTFD is 1: 0 to 65535.

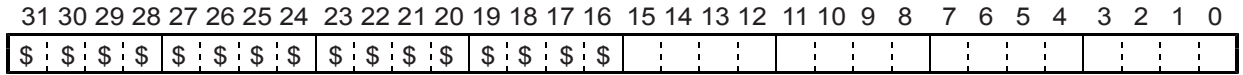

Bits marked with a "\$" will be the same as bit 15 when LTFD (bit 14) in the RENV5 register is 0 (sign extension), and they will be 0 when the LTFD is 1.

8-3-33. RLTC4 register

Latched data for COUNTER4 (general-purpose). (Read only.)

The contents of COUNTER4 are copied when triggered by the LTC, an ORG input, or an LTCH command.

Data range: -134,217,728 to +134,217,727.

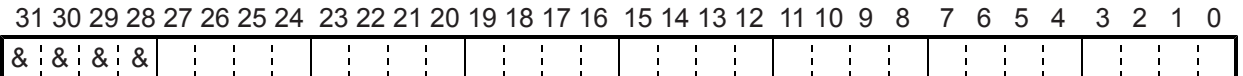

For details about the counter data latch, see section 11-10, "Counter."

Note 1: Bits marked with an "*" (asterisk) will be ignored when written and are 0 when read.
 Note 2: Bits marked with an "&" symbol will be ignored when written and will be the same value as the upper most bit among bits having no marks when read. (Sign extension)

8-3-34. RSTS register

The extension status can be checked. (Read only.)

15	14	13	12	11	10	9	8	7	6	5	4	3	2	1	0
SDIN	SLTC	SCLR	SDRM	SDRP	SEZ	SERC	SPCS	SEMG	SSTP	SSTA	SDIR	CND3	CND2	CND1	CND0
31	30	29	28	27	26	25	24	23	22	21	20	19	18	17	16
0	0	0	0	0	0	0	0	0	0	PFM1	PFM0	PFC1	PFC0	0	SINP

Bit	Bit name	Description
0 to 3	CND0 to 3	Reports the operation status. 0000: Under stopped condition 0001: Waiting for DR input 0010: Waiting for \overline{CSTA} input 0011: Waiting for an internal synchronous signal 0100: Waiting for another axis to stop. 0101: Waiting for a completion of ERC timer 0110: Waiting for a completion of direction change timer 0111: Correcting backlash 1000: Waiting for PAVPB input 1001: Feeding at FA low speed. 1010: Feeding at FL low speed. 1011: Accelerating 1100: Feeding at FH low speed. 1101: Decelerating 1110: Waiting for INP input. 1111: Others (controlling start)
4	SDIR	Operation direction (0: Positive direction. 1: Negative direction.)
5	SSTA	Becomes 1 when the \overline{CSTA} input signal is turned ON.
6	SSTP	Becomes 1 when the \overline{CSTP} input signal is turned ON.
7	SEMG	Becomes 1 when the \overline{CEMG} input signal is turned ON.
8	SPCS	Becomes 1 when the PCS input signal is turned ON.
9	SERC	Becomes 1 when the ERC input signal is turned ON.
10	SEZ	Becomes 1 when the EZ input signal is turned ON.
11	SDRP	Becomes 1 when the +DR input signal is turned ON.
12	SDRM	Becomes 1 when the -DR input signal is turned ON.
13	SCLR	Becomes 1 when the CLR input signal is turned ON.
14	SLTC	Becomes 1 when the LTC input signal is turned ON.
15	SDIN	Becomes 1 when the SD input signal is turned ON. (Status of SD input terminal.)
16	SINP	Becomes 1 when the INP input signal is turned ON.
17	Not defined	(Always set to 0.)
18 to 19	PFC0 to 1	Used to monitor the condition of the RCMP5 pre-register.
20 to 21	PFM0 to 1	Used to monitor the condition of the operation pre-registers (other than RCMP5).
22 to 31	Not defined	(Always set to 0.)

8-3-35. REST register

Used to check the error interrupt cause. (Read only.)

The corresponding bit will be "1" when that item has caused an error interrupt.

This register is reset when read.

15	14	13	12	11	10	9	8	7	6	5	4	3	2	1	0
ESAO	ESPO	ESIP	ESDT	0	ESSD	ESEM	ESSP	ESAL	ESML	ESPL	ESC5	ESC4	ESC3	ESC2	ESC1
31	30	29	28	27	26	25	24	23	22	21	20	19	18	17	16
0	0	0	0	0	0	0	0	0	0	0	0	0	0	ESPE	ESEE

Bit	Bit name	Description
0	ESC1	Stopped when Comparator 1 conditions were met. (+SL)
1	ESC2	Stopped when Comparator 2 conditions were met. (-SL)
2	ESC3	Stopped when Comparator 3 conditions were met.
3	ESC4	Stopped when Comparator 4 conditions were met.
4	ESC5	Stopped when Comparator 5 conditions were met.
5	ESPL	Stopped by the +EL input being turned ON.
6	ESML	Stopped by the -EL input being turned ON.
7	ESAL	Stopped by the ALM input being turned ON.
8	ESSP	Stopped by the $\overline{\text{CSTP}}$ input being turned ON.
9	ESEM	Stopped by the $\overline{\text{CEMG}}$ input being turned ON.
10	ESSD	Decelerated and stopped by the SD input being turned ON.
11	Not defined	(Always set to 0.)
12	ESDT	Stopped by an operation data error. (Note 1)
13	ESIP	Simultaneous stop with another axis due to an error stop on the other axis during interpolation.
14	ESPO	An overflow occurred in the PA/PB input buffer counter.
15	ESAO	An out of range count occurred in the positioning counter during interpolation.
16	ESEE	An EA/EB input error occurred. (Does not stop)
17	ESPE	A PA/PB input error occurred. (Does not stop)
18 to 31	Not defined	(Always set to 0.)

Note 1: In any of the following cases, ESDT will be 1.

- 1) Write a Start command using linear interpolation 1 mode (MOD = 60h, 61h, 68h, and 69h) on only one axis.
- 2) Write a Start command using circular interpolation mode (MOD = 64h, 65h, 66h, 67h, 6Ch, and 6Dh) on only one axis.
- 3) Write a Start command using the circular interpolation mode after setting PRIP (arc center coordinates) to (0, 0).
- 4) Write a Start command using circular interpolation mode on 3 or 4 axes.
- 5) Write a Start command using linear interpolation 2 mode (MOD = 62h, 63h, 6Ah, and 6Bh) while RIP is 0.
- 6) Tried to write a Start command using circular interpolation mode (MOD = 66h, 67h) while synchronized with the U axis. But the U axis did not respond. Or, the U axis completed operation while in arc interpolation mode.

8-3-36. RIST register

This register is used to check the cause of event interruption. (Read only.)

When an event interrupt occurs, the bit corresponding to the cause will be set to 1.

This register is reset when read.

15	14	13	12	11	10	9	8	7	6	5	4	3	2	1	0
ISOL	ISLT	ISCL	ISC5	ISC4	ISC3	ISC2	ISC1	ISDE	ISDS	ISUE	ISUS	ISND	ISNM	ISN	ISEN
31	30	29	28	27	26	25	24	23	22	21	20	19	18	17	16
0	0	0	0	0	0	0	0	0	0	0	0	ISSA	ISMD	ISPD	ISSD

Bit	Bit name	Description
0	ISEN	Stopped automatically.
1	ISN	The next operation starts continuously.
2	ISNM	Available to write operation to the 2nd pre-register.
3	ISND	Available to write operation to the 2nd pre-register for Comparator 5.
4	ISUS	Starting acceleration.
5	ISUE	Ending acceleration.
6	ISDS	Starting deceleration.
7	ISDE	Ending deceleration.
8	ISC1	The comparator 1 conditions were met.
9	ISC2	The comparator 2 conditions were met.
10	ISC3	The comparator 3 conditions were met.
11	ISC4	The comparator 4 conditions were met.
12	ISC5	The comparator 5 conditions were met..
13	ISCL	The count value was reset by a CLR signal input.
14	ISLT	The count value was latched by an LTC input.
15	ISOL	The count value was latched by an ORG input.
16	ISSD	The SD input turned ON.
17	ISPD	The +DR input changed.
18	ISMD	The -DR input changed.
19	ISSA	The \overline{CSTA} input turned ON.
20 to 31	Not defined	(Always set to 0.)

8-3-37. RPLS register

This register is used to check the value of the positioning counter (number of pulses left for feeding). (Read only.)

At the start, this value will be the absolute value in the RMV register. Each pulse that is output will decrease this value by one.

31	30	29	28	27	26	25	24	23	22	21	20	19	18	17	16	15	14	13	12	11	10	9	8	7	6	5	4	3	2	1	0	
0	0	0	0																													

8-3-38. RSPD register

This register is used to check the EZ count value and the current speed. (Read only.)

15	14	13	12	11	10	9	8	7	6	5	4	3	2	1	0
AS15	AS14	AS13	AS12	AS11	AS10	AS9	AS8	AS7	AS6	AS5	AS4	AS3	AS2	AS1	AS0
31	30	29	28	27	26	25	24	23	22	21	20	19	18	17	16
0	0	0	0	0	0	0	0	0	IDC2	IDC1	IDC0	ECZ3	ECZ2	ECZ1	ECZ0

Bit	Bit name	Description
0 to 15	AS0 to 15	Read the current speed as a step value (same units as for RFL and RFH). When stopped the value is 0.
16 to 19	ECZ0 to 3	Read the count value of EZ input that is used for a zero return.
20 to 22	IDC0 to 2	Read the idling count value.
23 to 31	Not defined	(Always set to 0.)

8-3-39. RSDC register

This register is used to check the automatically calculated ramping-down point value for the positioning operation. (Read only.)

31	30	29	28	27	26	25	24	23	22	21	20	19	18	17	16	15	14	13	12	11	10	9	8	7	6	5	4	3	2	1	0	
0	0	0	0	0	0	0	0																									

8-3-40. PRCI (RCI) registers

These registers are used to set circular interpolation stepping number.

RCI is the pre-register for the PRCI.

These registers only exist for the X, Y, and Z axes. They do not exist for the U axis because the U axis is not available for circular interpolation control.

To decelerate during a circular interpolation, enter the number of steps (number of operations) required for the circular interpolation. Entering a number other than 0 can decelerate the speed by using an automatic ramping-down point.

Setting range: 0 to 2,147,483,648.

31	30	29	28	27	26	25	24	23	22	21	20	19	18	17	16	15	14	13	12	11	10	9	8	7	6	5	4	3	2	1	0
*																															

8-3-41. RCIC register

This register is used to read the count of the number of circular interpolation steps that have been completed. (Read only.)

The RCI register value is loaded when a circular interpolation is started. This value is decreased by one for each circular interpolation step. However, if the counter value is 0, the PCL will not decrease it further.

The counter value at the completion of a circular interpolation is held in the PCL memory until the start of the next circular interpolation operation. The range for this value is 0 to 2,147,483,647.

This register is shared by all axes, and the value is same when read from any axis.

31	30	29	28	27	26	25	24	23	22	21	20	19	18	17	16	15	14	13	12	11	10	9	8	7	6	5	4	3	2	1	0
0																															

8-3-42. RIPS register

This register is used to check the interpolation setting status and the operation status. (Read only.)

This register is shared by all axes, and the value is same when read from any axis.

15	14	13	12	11	10	9	8	7	6	5	4	3	2	1	0
IPFu	IPFz	IPFy	IPFx	IPSu	IPSz	IPSy	IPSx	IPEu	IPEz	IPEy	IPEx	IPLu	IPLz	IPLy	IPLx
31	30	29	28	27	26	25	24	23	22	21	20	19	18	17	16
0	.0	.0	.0	0	.0	.0	.0	SED1	SED0	SDM1	SDM0	IPCC	IPCW	IPE	IPL

Bit	Bit name	Description
0	IPLx	1: X axis is in linear interpolation 1 mode.
1	IPLy	1: Y axis is in linear interpolation 1 mode.
2	IPLz	1: Z axis is operating in linear interpolation 1 mode.
3	IPLu	1: U axis is operating in linear interpolation 1 mode.
4	IPEx	1: X axis is in linear interpolation 2 mode.
5	IPEy	1: Y axis is in linear interpolation 2 mode.
6	IPEz	1: Z axis is operating in linear interpolation 2 mode.
7	IPEu	1: U axis is operating in linear interpolation 2 mode.
8	IPSx	1: X axis is in circular interpolation mode.
9	IPSy	1: Y axis is in circular interpolation mode.
10	IPSz	1: Z axis is operating in circular interpolation mode.
11	IPSu	1: U axis is operating in circular interpolation mode.
12	IPFx	1: X axis is specified for constant synthetic speed.
13	IPFy	1: Y axis is specified for constant synthetic speed.
14	IPFz	1: Z axis is operating at a specified constant synthesized speed.
15	IPFu	1: U axis is operating at a specified constant synthesized speed.
16	IPL	1: Executing linear interpolation 1.
17	IPE	1: Executing linear interpolation 2.
18	IPCW	1: Executing a CW directional circular interpolation.
19	IPCC	1: Executing a CCW directional circular interpolation.
20 to 21	SDM0 to 1	Current phase of a circular interpolation (00: 1st phase, 01: 2nd phase, 10: 3rd phase, 11: 4th phase)
22 to 23	SED0 to 1	Final phase in a circular interpolation (00: 1st phase, 01: 2nd phase, 10: 3rd phase, 11: 4th phase)
24 to 31	Not defined	(Always set to 0.)

9. Operation Mode

Specify the basic operation mode using the MOD area (bits 0 to 6) in the RMD (operation mode) register.

9-1. Continuous operation mode using command control

This is a mode of continuous operation. A start command is written and operation continues until a stop command is written.

MOD	Operation method	Direction of movement
00h	Continuous operation from a command	Positive direction
08h	Continuous operation from a command	Negative direction

Stop by turning ON the EL signal corresponding to the direction of operation.

When operation direction is positive, +EL can be used. When operation direction is negative, -EL is used. In order to start operation in the reverse direction after stopping the motion by turning ON the EL signal, a new start command must be written.

9-2. Positioning operation mode

The following seven operation types are available for positioning operations.

MOD	Operation method	Direction of movement
41h	Positioning operation (specify target increment position)	Positive direction when $PRMV \geq 0$ Negative direction when $PRMV < 0$
42h	Positioning operation (specify the absolute position in COUNTER1)	Positive direction when $PRMV \geq COUNTER1$ Negative direction when $PRMV < COUNTER1$
43h	Positioning operation (specify the absolute position in COUNTER2)	Positive direction when $PRMV \geq COUNTER2$ Negative direction when $PRMV < COUNTER2$
44h	Return to command position 0 (COUNTER1)	Positive direction when $COUNTER1 \leq 0$ Negative direction when $COUNTER1 > 0$
45h	Return to machine position 0 (COUNTER2)	Positive direction when $COUNTER2 \leq 0$ Negative direction when $COUNTER2 > 0$
46h	One pulse operation	Positive direction
4Eh	One pulse operation	Negative direction
47h	Timer operation	

9-2-1. Positioning operation (specify a target position using an incremental value) (MOD: 41h)

This is a positioning mode used by placing a value in the PRMV (target position) register.

The feed direction is determined by the sign set in the PRMV register.

When starting, the RMV register setting is loaded into the positioning counter (RPLS). The PCL instructs to feed respective axes to zero direction. When the value of the positioning counter drops to 0, movement on the axes stops. When you set the PRMV register value to zero to start a positioning operation, the LSI will stop outputting pulses immediately.

9-2-2. Positioning operation (specify the absolute position in COUNTER1) (MOD: 42h)

This mode only uses the difference between the PRMV (target position) register value and COUNTER1. Since the COUNTER1 value is stored when starting to move, the PCL cannot be overridden by changing the COUNTER1 value. But, the target position can be overridden by changing the RMV value. The direction of movement can be set automatically by evaluating the relative relationship between the PRMV register setting and the value in COUNTER1.

At start up, the difference between the RMV setting and the value stored in COUNTER1 is loaded into the positioning counter (RPLS). The PCL moves toward the zero position. When the positioning counter value reaches zero, it stops operation.

If the PRMV register value is made equal to the COUNTER1 value and the positioning operation is started, the PCL will immediately stop operation without outputting any command pulses.

9-2-3. Positioning operation (specify the absolute position in COUNTER2) (MOD: 43h)

This mode only uses the difference between the PRMV (target position) register setting and the value in COUNTER2.

Since the COUNTER2 value is stored when starting a positioning operation, the PCL cannot be overridden by changing the value in COUNTER2; however, it can override the target position by changing the value in RMV.

The direction of movement can be set automatically by evaluating the relationship between the PRMV register setting and the value in COUNTER2.

At start up, the difference between the RMV setting and the value stored in COUNTER2 is loaded into the positioning counter (RPLS). The PCL moves in the direction to the zero position. When the positioning counter value reaches zero, it stops operation.

If the PRMV register value is made equal to the COUNTER2 value and the positioning operation is started, the PCL will immediately stop operation without outputting any command pulses.

9-2-4. Command position 0 return operation (MOD: 44h)

This mode continues operation until the COUNTER1 (command position) value becomes zero.

The direction of movement is set automatically by the sign for the value in COUNTER1 when starting.

This operation is the same as when positioning (specify the absolute position in COUNTER1) by entering zero in the PRMV register; however, there is no need to specify the PRMV register.

9-2-5. Machine position 0 return operation (MOD: 45h)

This mode is used to continue operations until the value in COUNTER2 (mechanical position) becomes zero.

The number of output pulses and feed direction are set automatically by internal calculations based on the COUNTER2 value when starting.

This operation is the same as when positioning (specify the absolute position in COUNTER2) by entering zero in the PRMV register. However, there is no need to specify the PRMV register.

9-2-6. One pulse operation (MOD: 46h, 4Eh)

This mode outputs a single pulse.

This operation is identical to a positioning operation (incremental target positioning) that writes a "1" (or "-1") to the RMV register. However, with this operation, you do not need to write a "1" or "-1" to the RMV register.

9-2-7. Timer operation (MOD: 47h)

This mode allows the internal operation time to be used as a timer.

The internal effect of this operation is identical to the positioning operation. However, the LSI does not output any pulses (they are masked).

Therefore, the internal operation time using the low speed start command will be a product of the frequency of the output pulses and the RMV register setting. (Ex.: When the frequency is 1000 pps and the RMS register is set to 120 pulses, the internal operation time will be 120 msec.)

Write a positive number (1 to 134,217,727) into the RMV register.

The \pm EL input signal, SD input signal, and software limits are ignored. (These are always treated as OFF.)

The ALM input signal, $\overline{\text{CSTP}}$ input signal, and $\overline{\text{CEMG}}$ input signals are effective.

The backlash/slip correction, vibration restriction function, and when changing direction, this timer function is disabled.

The LSI stops counting from COUNTER1 (command position).

Regardless of the MINP setting (bit 9) in the RMD (operation mode) register, an operation complete delay controlled by the INP signal will not occur.

In order to eliminate deviations in the internal operation time, set the METM (bit 12) in the PRMD register to zero and use the cycle completion timing of the output pulse as the operation complete timing.

9-3. Pulsar (PA/PB) input mode

This mode is used to allow operations from a pulsar input.

In order to enable pulsar input, bring the \overline{PE} terminal LOW. Set POFF in the RENV2 register to zero.

It is also possible to apply a filter on the \overline{PE} input.

After writing a start command, when a pulsar signal is input, the LSI will output pulses to the OUT terminal. Use an FL low speed start (STAF_L: 50h) or an FH low speed start (STAF_H: 51h).

Four methods are available for inputting pulsar signals through the PA/PB input terminal by setting the RENV2 (environmental setting 2) register.

- ◆ Supply a 90° phase difference signal (1x, 2x, or 4x).
- ◆ Supply either positive or negative pulses.

Note: The backlash correction function is available with the pulsar input mode. However, reversing pulsar input while in the backlash correction is unavailable.

Besides the above 1x to 4x multiplication, the PCL has a multiplication circuit of 1x to 32x and division circuit of (1 to 2048)/2048. For setting the multiplication from 1x to 32x, specify the PMG0 to 4 in the RENV6 and for setting the division of n/2048, specify the PD0 to 10 in the RENV6.

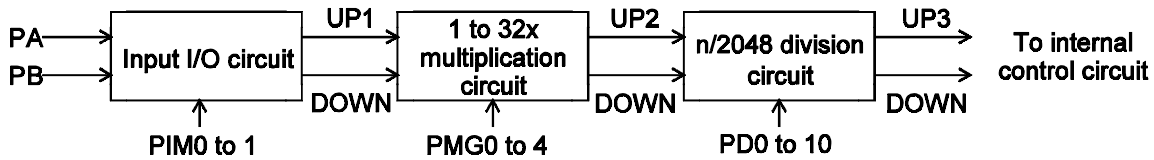

The timing of the UP1 and DOWN1 signals will be as follows by setting of the PIM0 to PIM1 in the RENV2.

1) When using 90° phase difference signals and 1x input (PIM = 00)

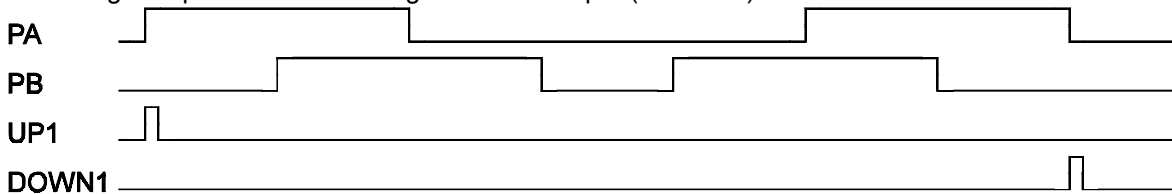

2) When using 90° phase difference signals and 2x input (PIM = 01)

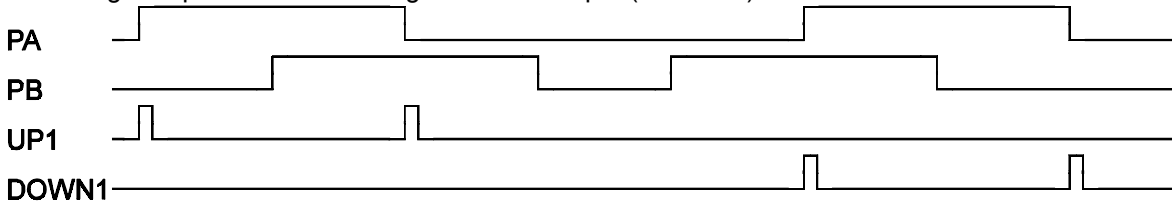

3) When using 90° phase difference signals and 4x input (PIM = 10)

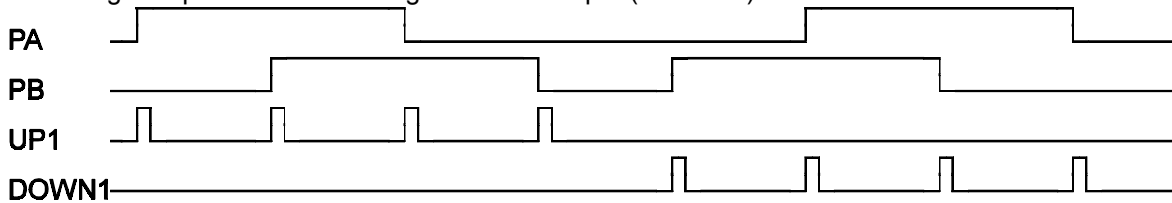

4) When using two pulse input.

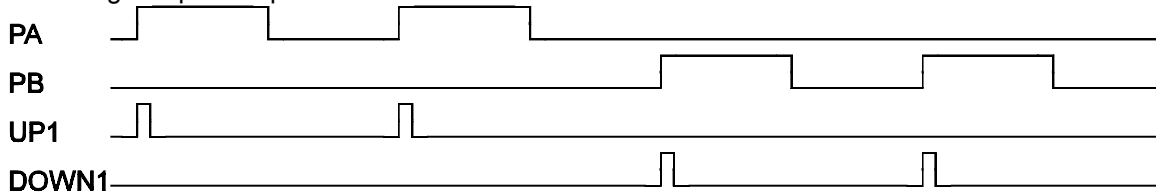

When the 1x to 32x multiplication circuit is set to 3x (PMG = 2 on the RENV6), operation timing will be as follows.

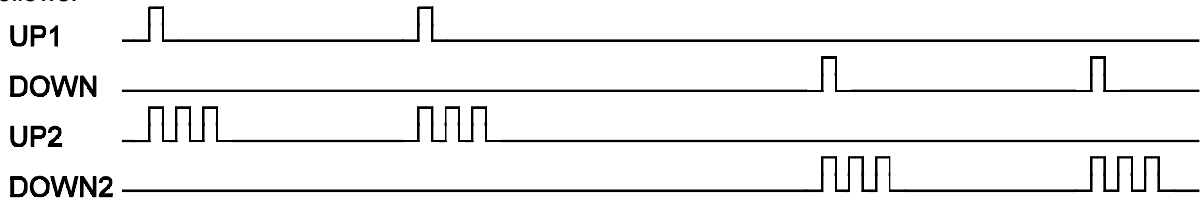

When the n/2048 division circuit is set to 512/2048 (PD =512 on the RENV6), operation timing will be as follows.

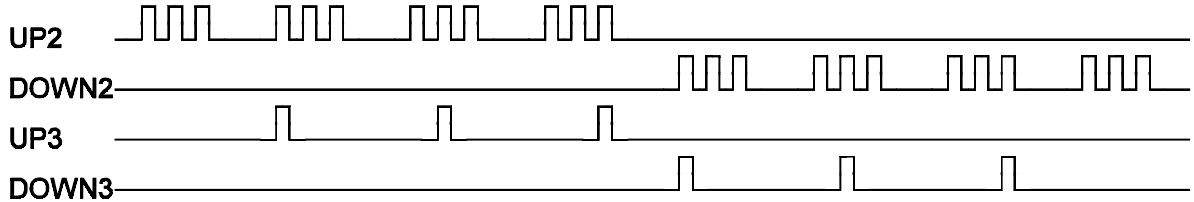

The pulsar input mode is triggered by an FL constant speed start command (50h) or by an FH constant speed start command (51h).

Pulsar input causes the PCL to output pulses with some pulses from the FL speed or FH speed pulse outputs being omitted. Therefore, there may be a difference in the timing between the pulsar input and output pulses, up to the maximum internal pulse frequency.

The maximum input frequency for pulsar signals is restricted by the FL speed when an FL low speed start is used, and by the FH speed when an FH low speed start is used. The LSI outputs \overline{INT} signals as errors when both the PA and PB inputs change simultaneously, or when the input frequency is exceeded, or if the input/output buffer counter (deflection adjustment 16-bit counter for pulsar input and output pulse) overflows. This can be monitored by the REST (error interrupt factor) register.

$$FP < (\text{speed}) / (\text{input I/F phase value}) / (\text{PMG setting value} + 1) / (\text{PD setting value} / 2048), \text{PD setting value} \neq 0$$

$$FP < (\text{speed}) / (\text{input I/F phase value}), \text{PD setting value} = 0$$

<Examples of the relationship between the FH (FL) speed [pps] and the pulsar input frequency FP [pps]>

PA/PB input method	PMG setting value	PD setting value	Usable range
2 pulse input	0 (1x)	0	$FP < FH (FL)$
	0 (1x)	1024	$FP < FH (FL) \times 2$
	2 (3x)	0	$FP < FH (FL) / 3$
90° phase difference 1x	0 (1x)	0	$FP < FH (FL)$
	0 (1x)	1024	$FP < FH (FL) \times 2$
	2 (3x)	0	$FP < FH (FL) / 3$
90° phase difference 2x	0 (1x)	0	$FP < FH (FL) / 2$
	0 (1x)	1024	$FP < FH (FL)$
	2 (3x)	0	$FP < FH (FL) / 6$
90° phase difference 4x	0 (1x)	0	$FP < FH (FL) / 4$
	0 (1x)	1024	$FP < FH (FL) / 2$
	2 (3x)	0	$FP < FH (FL) / 6$

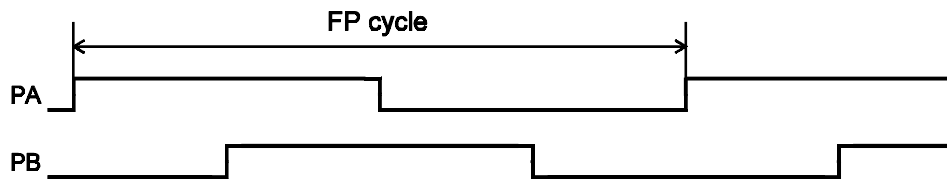

Note: When the PA/ PB input frequency fluctuates, take the shortest frequency, not average frequency, as "Frequency of FP" above.

<Setting relationship of PA/PB input>

Specify the PA/PB input <Set to PIM0 to 1 (bit 24 & 25) in RENV2> 00: 90° phase difference, 1x 10: 90° phase difference, 4x 01: 90° phase difference, 2x 11: 2 sets of up or down input pulses	[RENV2] (WRITE) 31 24 - - - - - n n
Specify the PA/PB input count direction <Set to PDIR (bit 26) in RENV2> 0: Count up when the PA phase is leading. Or, count up on the rising edge of PA. 1: Count up when the PB phase is leading. Or, count up on the rising edge of PB.	[RENV2] (WRITE) 31 24 - - - - - n - -
Enable/disable PA/PB input <Set POFF (bit 31) in RENV2> 0: Enable PA/PB input 1: Disable PA/PB input.	[RENV2] (WRITE) 31 24 n - - - - - - -
Set the +/- DR, P \bar{E} input filter <Set DRF (bit 27) in RENV1> 1: Insert a filter on +/- DR input and P \bar{E} input By setting the filter, the PCL ignores signals shorter than 32 msec.	[RENV1] (WRITE) 31 24 - - - - - n - - - -
Reading operation status <CND (bit 0 to 3) in RSTS> 1000 : wait for PA/ PB input.	[RSTS] (READ) 7 0 - - - - - n n n n
Reading PA/PB input error <ESPE (bit 17) in REST> ESPE (bit 17) = 1: Occurs a PA/PB input error	[REST] (READ) 23 16 0 0 0 0 0 0 n -
Reading PA/PB input buffer counter status <ESP0 (bit 14) in REST> ESPO (bit 14) = 1: Occurs an overflow.	[REST] (READ) 15 8 - n - - - - - - -

* In the descriptions in the right hand column, "n" refers to the bit position. "0" refers to bit positions where it is prohibited to write any value except zero and the bit will always be zero when read.

The pulsar input mode has the following 12 operation types.

The direction of movement for continuous operation can be changed by setting the RENV2 register, without changing the wiring connections for the PA/PB inputs.

MOD	Operation mode	Direction of movement
01h	Continuous operation using pulsar input	Determined by the PA/PB input.
51h	Positioning operation using pulsar input (absolute position)	Determined by the sign of the PRMV value.
52h	Positioning operation using pulsar input (COUNTER1 absolute position)	Determined by the relationship of the RMV and COUNTER1 values.
53h	Positioning operation using pulsar input (COUNTER2 absolute position)	Determined by the relationship of the RMV and COUNTER2 values.
54h	Specified position (COUNTER1) zero point return operation using pulsar input	Determined by the sign of the value in COUNTER1.
55h	Specified position (COUNTER2) zero point return operation using pulsar input	Determined by the sign of the value in COUNTER2.
68h	Continuous linear interpolation 1 using pulsar input	Determined by the sign of the value in PRMV.
69h	Linear interpolation 1 using pulsar input	Determined by the sign of the value in PRMV.
6Ah	Continuous linear interpolation 2 using pulsar input	Determined by the sign of the value in PRMV.
6Bh	Linear interpolation 2 using pulsar input	Determined by the sign of the value in PRMV.
6Ch	CW circular interpolation using pulsar input	Determined by the circular interpolation operation
6Dh	CCW circular interpolation using pulsar input	Determined by the circular interpolation operation

9-3-1. Continuous operation using a pulsar input (MOD: 01h)

This mode allows continuous operation using a pulsar input.

When PA/PB signals are input after writing a start command, the LSI will output pulses to the OUT terminal.

The feed direction depends on PA/PB signal input method and the value set in PDIR.

PA/PB input method	PDIR	Feed direction	PA/PB input
90° phase difference signal (1x, 2x, and 4x)	0	Positive direction	When the PA phase leads the PB phase.
		Negative direction	When the PB phase leads the PA phase.
	1	Positive direction	When the PB phase leads the PA phase.
		Negative direction	When the PA phase leads the PB phase.
2 pulse input of positive and negative pulses	0	Positive direction	PA input rising edge.
		Negative direction	PB input rising edge.
	1	Positive direction	PB input rising edge.
		Negative direction	PA input rising edge.

The PCL stops operation when the EL signal in the current feed direction is turned ON. But the PCL can be operated in the opposite direction without writing a restart command.

When stopped by the EL input, no error interrupt (INToutput) will occur.

To release the operation mode, write an immediate stop command (49h).

Note: When the "immediate stop command (49h)" is written while the PCL is performing a multiplication operation (caused by setting PIM 0 to 1 and PMG 0 to 4), the PCL will stop operation immediately and the total number of pulses that are output will not be an even multiple of the magnification. When PSTP in RENV6 is set to 1, the PCL delays the stop timing until an even multiple of pulses has been output. However, after a stop command is sent by setting PSTP to 1, check the MSTs. If SRUN is 0, set PSTP to 0. (When SRUN is 0 while PSTP is 1, the PCL will latch the stop command.)

9-3-2. Positioning operations using a pulsar input (MOD: 51h)

The PCL positioning is synchronized with the pulsar input by using the PRMV setting as incremental position data.

This mode allows positioning using a pulsar input.

The feed direction is determined by the sign in the PMV register.

When PA/PB signals are input, the LSI outputs pulses and the positioning counter counts down. When the value in the positioning counter reaches zero, movement on the axis will stop and another PA/ PB input will be ignored. Set the RMV register value to zero and start the positioning operation. The LSI will stop movement on the axis immediately, without outputting any command pulses.

9-3-3. Positioning operation using a pulsar input (specify absolute position to COUNTER1) (MOD: 52h)

The PCL positioning is synchronized with the pulsar input by using the PRMV setting as the absolute value for COUNTER1.

The direction of movement is determined by the relationship between the value in PRMV and the value in COUNTER1.

When starting, the difference between the values in RMV and COUNTER1 is loaded into the positioning counter. When a PA/PB signal is input, the PCL outputs pulses and decrements the positioning counter. When the value in the positioning counter reaches "0," the PCL any further ignores PA/PB input. If you try to start with PRMV = COUNTER1, the PCL will not output any pulses and it will stop immediately.

9-3-4. Positioning operation using a pulsar input (specify the absolute position in COUNTER2) (MOD: 53h)

The operation procedures are the same as MOD= 52h, except that this function uses COUNTER2 instead of COUNTER1.

9-3-5. Command position zero return operation using a pulsar input (MOD: 54h)

This mode is used to feed the axis using a pulsar input until the value in COUNTER1 (command position) becomes zero. The number of pulses output and the feed direction are set automatically by internal calculation, using the COUNTER1 value when starting.

Set the COUNTER1 value to zero and start the positioning operation, the LSI will stop movement on the axis immediately, without outputting any command pulses.

9-3-6. Mechanical position zero return operation using a pulsar input (MOD: 55h)

Except for using COUNTER2 instead of COUNTER1, the operation details are the same as for MOD = 54h.

9-3-7. Continuous linear interpolation 1 using pulsar input (MOD: 68h)

Performs continuous linear interpolation 1, synchronized with the pulsar input.

For continuous linear interpolation 1 operation details, see section "9-8. Interpolation operations."

9-3-8. Linear interpolation 1 using pulsar input (MOD: 69h)

Performs linear interpolation 1, synchronized with the pulsar input.

Any pulsar inputs after operation is complete will be ignored.

For linear interpolation 1 operation details, see section "9-8. Interpolation operations."

9-3-9. Continuous linear interpolation 2 using pulsar input (MOD: 6Ah)

Performs continuous linear interpolation 2, synchronized with the pulsar input.

For continuous linear interpolation 2 operation details, see section "9-8. Interpolation operations."

9-3-10. Linear interpolation 2 using pulsar input (MOD: 6Bh)

Performs linear interpolation 2, synchronized with the pulsar input.

Any pulsar inputs after operation is complete will be ignored.

For linear interpolation 2 operation details, see section "9-8. Interpolation operations."

9-3-11. CW circular interpolation using pulsar input (MOD: 6Ch)

Performs CW circular interpolation, synchronized with the pulsar input.

Any pulsar inputs after operation is complete will be ignored.

For CW circular interpolation operation details, see section "9-8. Interpolation operations."

9-3-12. CCW circular interpolation using pulsar input (MOD: 6Dh)

Performs CCW circular interpolation, synchronized with the pulsar input.

Any pulsar inputs after operation is complete will be ignored.

For CCW circular interpolation operation details, see section "9-8. Interpolation operations."

9-4. External switch (\pm DR) operation mode

This mode allows operations with inputs from an external switch.

To enable inputs from an external switch, bring the \overline{PE} terminal LOW.

After writing a start command, when a +DR/-DR signal is input, the LSI will output pulses to the OUT terminal.

Set the RENV1 (environment 1) register to specify the output logic of the \pm DR input signal. The \overline{INT} signal can be set to send an output when \pm DR input is changed.

The RSTS (extension status) register can be used to check the operating status and monitor the \pm DR input.

It is also possible to apply a filter to the \pm DR or \overline{PE} inputs.

Set the input logic of the +DR/-DR signals <Set DRL (bit 25) in RENV1 > 0: Negative logic 1: Positive logic	[RENV1] (WRITE) 31 24 - - - - - n -
Applying a \pm DR or \overline{PE} input filter <Set DRF (bit 27) in RENV1> 1: Apply a filter to \pm DR input or \overline{PE} inputs When a filter is applied, pulses shorter than 32 msec will be ignored.	[RENV1] (WRITE) 31 24 - - - - n - - -
Setting an event interrupt cause <Set IRDR (bit 17) in RIRQ> 1: Output the \overline{INT} signal when \pm DR signal changed input.	[RIRQ] (WRITE) 23 16 0 0 0 0 0 - n -
Reading the event interrupt cause <ISPD (bit 17) and ISMD (bit 18) in RIST> ISPD(bit 17) = 1: When the +DR signal input changes. ISMD(bit 18) = 1: When the -DR signal input changes.	[RIST] (READ) 23 16 0 0 0 0 - n n -
Read operation status <CND (bits 0 to 3) in RSTS> 0001: Waiting for a DR input	[RSTS] (READ) 7 0 - - - - n n n n
Reading the \pm DR signal <SDRP (bit 11) and SDRM (bit 12) in RSTS> SDRP = 0: +DR signal is OFF SDRP = 1: +DR signal is ON SDRM = 0: -DR signal is OFF SDRM = 1: -DR signal is ON	[RSTS] (READ) 15 8 - - - n n - - -

The external switch operation mode has the following two forms

MOD	Operation mode	Direction of movement
02h	Continuous operation using an external switch.	Determined by +DB, - DR input.
56h	Positioning operation using an external switch.	Determined by +DB, - DR input.

9-4-1. Continuous operation using an external switch (MOD: 02h)

This mode is used to operate an axis only when the DR switch is ON.

After writing a start command, turn the +DR signal ON to feed the axis in the positive direction, turn the -DR signal ON to feed the axis in the negative direction, using a specified speed pattern.

By turning ON an EL signal for the feed direction, movement on the axis will stop. However, the axis can be fed in the reverse direction.

An error interrupt (\overline{INT} output) will not occur.

To end this operation mode, write an immediate stop command (49h).

If the axis is being fed with high speed commands (52h, 53h), movement on the axis will decelerate and stop when the DR input turns OFF. If the DR input for reverse direction turns ON while decelerating, movement on the axis will decelerate and stop. Then it will resume in the opposite direction.

[Setting example]

- 1) Bring the \overline{PE} input LOW.
- 2) Specify RFL, RFH, RUR, RDR, and RMG (speed setting).
- 3) Enter "000010" for MOD (bits 0 to 6) in the RMD (operation mode) register
- 4) Write a start command (50h to 53h).

CND (bits 0 to 3) of the RSTS (extension status) register will wait for "0001: DR input."

In this condition, turn ON the +DR or -DR input terminal. The axis will move in the specified direction using the specified speed pattern as long as the terminal is kept ON.

9-4-2. Positioning operation using an external switch (MOD: 56h)

This mode is used for positioning based on the DR input rising timing.

When started, the data in the RMV register is loaded into the positioning counter. When the DR input is ON, the LSI will output pulses and the positioning counter will start counting down pulses. When the positioning counter value reaches zero, the PCL stops operation.

Even if the DR input is turned OFF or ON again during the operation, it will have no effect on the operation. If you make the REMV register value 0 and start a positioning operation, the PCL will stop operation immediately without outputting any command pulses.

Turn ON the +DR signal to feed in the positive direction. Turn ON the -DR signal to feed in the negative direction.

By turning ON the EL signal corresponding to the feed direction, the axis will stop operation and issue an error interrupt (INT output).

9-5. Zero position operation mode

The following six zero position operation modes are available.

MOD	Operation mode	Direction of movement
10h	Zero return operation	Positive direction
18h	Zero return operation	Negative direction
12h	Leaving the zero position operation	Positive direction
1Ah	Leaving the zero position operation	Negative direction
15h	Zero position search operation	Positive direction
1Dh	Zero position search operation	Negative direction

Depending on the operation method, the zero position operation uses the ORG, EZ, or \pm EL inputs. Specify the input logic of the ORG input signal in the RENV1 (environment 1) register. This register's terminal status can be monitored with an SSTSW (sub status) command.

Specify the input logic of the EZ input signal in the RENV2 (environment 2) register. Specify the number for EZ to count up to for a zero return complete condition in the RENV3 (environment 3) register. This register's terminal status can be monitored by reading the RSTS (extension status) register.

Specify the logic for the \pm EL input signal using the ELL input terminals. Specify the operation to execute when the signal turns ON (immediate stop/deceleration stop) in the RENV1 register. This register's terminal status can be monitored with an SSTSW (sub status) command.

An input filter can be applied to the ORG input signal and \pm EL input signal by setting the RENV1 register.

Set the ORG signal input logic <Set ORGL (bit 7) in RENV1 > 0: Negative logic 1: Positive logic	[RENV1] (WRITE) 7 0 n - - - - -
Read the ORG signal <SORG (bit14) in SSTSW> 0: Turn OFF the ORG signal 1: Turn ON the ORG signal	[SSTSW] (READ) 15 8 - n - - - - -
Set the EZ signal input logic <Set EZL (bit 23) in RENV2> 0: Falling edge 1: Rising edge	[RENV2] (WRITE) 23 16 n - - - - -
Set the EZ count <Set EZD0 to 3 (bits 4 to 7) in RENV3> Specify the number for EZ to count up to that will indicate a zero return completion. Enter the value (the count minus 1) in EZD0 to 3. Setting range: 0 to 15.	[RENV3] (WRITE) 7 0 n n n n - - - -
Read the EZ signal < SEZ (bit 10) in RSTS> 0: Turn OFF the EZ signal 1: Turn ON the EZ signal	[RSTS] (READ) 15 8 - - - - n - - -
Set the \pm EL signal input logic <ELL input terminal> L: Positive logic input H: Negative logic input	
Specify a method for stopping when the \pm EL signal turns ON <Set ELM (bit 3) in RENV1 > 0: Immediate stop when the \pm EL signal turns ON. 1: Deceleration stop when the \pm EL signal turns ON.	[RENV1] (WRITE) 7 0 - - - - n - - -
Read the \pm EL signal <SPEL (bit 12), SMEL (bit 13) in SSTSW> SPEL = 0: Turn OFF + EL signal SPEL = 1: Turn ON + EL signal SMEL = 0: Turn OFF - EL signal SMEL = 1: Turn ON - EL signal	[SSTSW] (READ) 15 8 - - n n - - - -
Applying an input filter to the \pm EL and ORG inputs <Set FLTR (bit 26) in RENV1> 1: Apply a filter to the \pm EL and ORG inputs. By applying a filter, pulses shorter than 4 μ sec will be ignored.	[RENV1] (WRITE) 31 24 - - - - n - - -

9-5-1. Zero return operation

After writing a start command, the axis will continue feeding until the conditions for a zero return complete are satisfied.

MOD: 10h Positive direction zero return operation

18h Negative direction zero return operation

When a zero return is complete, the LSI will reset the counter and output an ERC (deflection counter clear) signal.

The RENV3 register is used to set the basic zero return method. That is, whether or not to reset the counter when the zero return is complete. Specify whether or not to output the ERC signal in the RENV1 register.

For details about the ERC signal, see 11-6-2, "ERC signal."

Set the zero return method <Set ORM0 to 3 (bits 0 to 3) in RENV3>	[RENV3] (WRITE) 7 0 - - - n n n n
0000: Zero return operation 0 - Stop immediately (deceleration stop when feeding at high speed) when the ORG signal turns ON - COUNTER reset timing: When the ORG input signal turns ON.	
0001: Zero return operation 1 - Stop immediately (deceleration stop when feeding at high speed) when the ORG signal turns ON. Next, feed in the reverse direction at RFA low speed until the ORG signal turns OFF. Then, the axis moves back in the original direction at RFA speed and stops immediately when ORG turns ON again. - COUNTER reset timing: When the ORG input signal turns ON.	
0010: Zero return operation 2 - When feeding at low speed, after the ORG signal turns ON, movement on the axis stops immediately when the EZ counter finishes counting up. When feeding at high speed, after the ORG signal turns ON, the axis decelerates and stops immediately when the EZ counter finishes counting up. - COUNTER reset timing: When the EZ counter finishes counting up.	
0011: Zero return operation 3 - When feeding at low speed, after the ORG signal turns ON, movement on the axis stops immediately when the EZ counter finishes counting up. When feeding at high speed, after the ORG signal turns ON, the axis decelerates and stops immediately when the EZ counter finishes counting up. - COUNTER reset timing: When the EZ counter finishes counting up.	
0100: Zero return operation 4 - Movement on the axis stops immediately (decelerate and stop when feeding at high speed) when the ORG input is turned ON. Next, the direction of movement is reversed at RFA low speed. Then, it stops immediately when the EZ counter finishes counting up. - COUNTER reset timing: When the EZ counter finishes counting up.	

<p>0101: Zero return operation 5</p> <ul style="list-style-type: none"> - Movement on the axis stops immediately and is reversed (decelerates and stops when feeding at high speed) when the ORG input is turned ON. Then, all movement stops immediately (decelerates and stops when feeding at high speed) when the EZ counter finishes counting up. - COUNTER reset timing: When the EZ counter finishes counting up. <p>0110: Zero return operation 6</p> <ul style="list-style-type: none"> - Movement on the axis stops immediately (decelerates and stops when ELM is 1) when the EL signal turns ON, and it reverses at RFA low speed. Then, all movement stops immediately when the EL signal is turned OFF. - COUNTER reset timing: When the EL signal is turned OFF. <p>0111: Zero return operation 7</p> <ul style="list-style-type: none"> - Movement on the axis stops immediately (decelerates and stops when ELM is 1) when the EL signal turns ON, and reverses at RFA low speed. Then, all movement stops immediately when the EZ counter finishes counting up. - COUNTER reset timing: When the EZ counter finishes counting up. <p>1000: Zero return operation 8</p> <p>Movement on the axis stops immediately (decelerates and stops when ELM is 1) when the EL signal turns ON, and reverses. Then it stops immediately (decelerates and stops when feed at high speed) when the EZ counter finishes counting up.</p> <ul style="list-style-type: none"> - COUNTER reset timing: When the EZ counter finishes counting up. <p>1001: Zero return operation 9</p> <ul style="list-style-type: none"> - After the process in zero return operation 0 has executed, it returns to zero (operates until COUNTER2 = 0). <p>1010: Zero return operation 10</p> <ul style="list-style-type: none"> - After the process in zero return operation 3 has executed, it returns to zero (operates until COUNTER2 = 0). <p>1011: Zero return operation 11</p> <ul style="list-style-type: none"> - After the process in zero return operation 5 has executed, it returns to zero (operates until COUNTER2 = 0). <p>1100: Zero return operation 12</p> <ul style="list-style-type: none"> - After the process in zero return operation 8 has executed, it returns to zero (operates until COUNTER2 = 0). 	<p>[RENV3] (WRITE)</p> <p>7 0</p> <table border="1"> <tr> <td>-</td><td>-</td><td>-</td><td>-</td><td>n</td><td>n</td><td>n</td><td>n</td> </tr> </table>	-	-	-	-	n	n	n	n
-	-	-	-	n	n	n	n		
<p>Settings after a zero return complete <Set CU1R to 4R (bits 20 to 23) in RENV3></p> <p>CU1R (bit 20) =1: Reset COUNTER1 (command position)</p> <p>CU2R (bit 21) =1: Reset COUNTER2 (mechanical position)</p> <p>CU3R (bit 22) =1: Reset COUNTER3 (deflection counter)</p> <p>CU4R (bit 23) =1: Reset COUNTER4 (general-purpose)</p>	<p>[RENV3] (WRITE)</p> <p>23 16</p> <table border="1"> <tr> <td>n</td><td>n</td><td>n</td><td>n</td><td>-</td><td>-</td><td>-</td><td>-</td> </tr> </table>	n	n	n	n	-	-	-	-
n	n	n	n	-	-	-	-		
<p>Setting the ERC signal for automatic output <Set EROR (bit 11) in RENV1></p> <p>0: Does not output an ERC signal when a zero return is complete.</p> <p>1: Automatically outputs an ERC signal when a zero return is complete.</p>	<p>[RENV1] (WRITE)</p> <p>15 8</p> <table border="1"> <tr> <td>-</td><td>-</td><td>-</td><td>-</td><td>n</td><td>-</td><td>-</td><td>-</td> </tr> </table>	-	-	-	-	n	-	-	-
-	-	-	-	n	-	-	-		

9-5-1-1. Zero return operation 0 (ORM = 0000)

Low speed operation <Sensor: EL (ELM = 0), ORG>

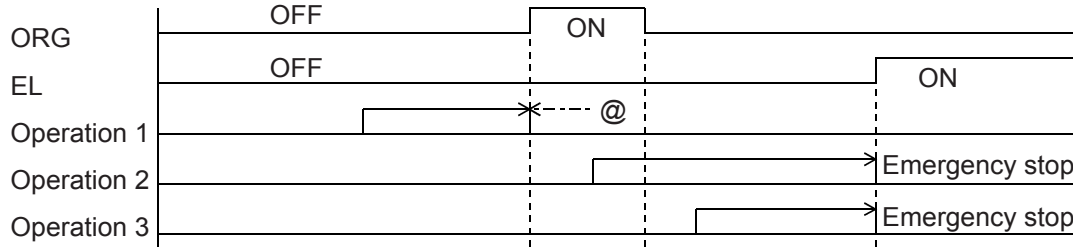

High speed operation <Sensor: EL (ELM = 0), ORG>

Even if the axis stops normally, it may not be at the zero position. However, COUNTER2 (mechanical position) provides a reliable value.

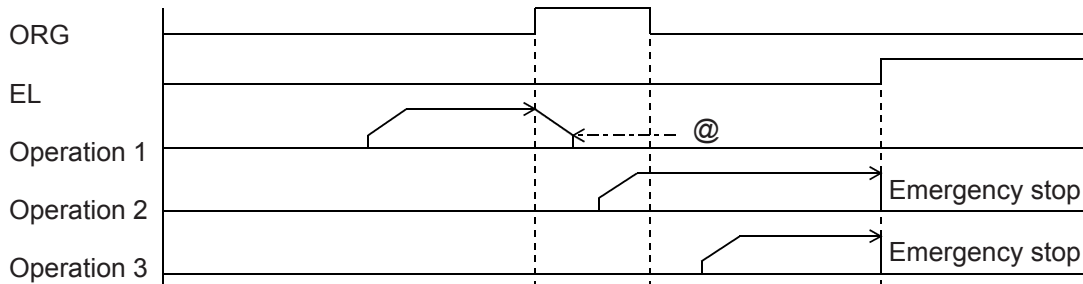

High speed operation <Sensor: EL (ELM = 1), ORG>

Even if the axis stops normally, it may not be at the zero position. However, COUNTER2 (mechanical position) provides a reliable value.

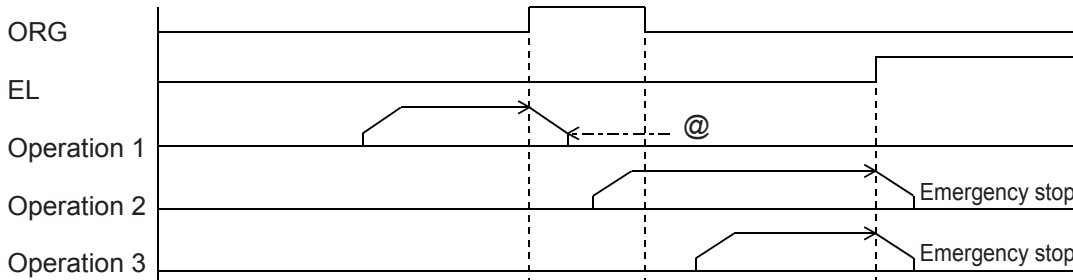

High speed operation <Sensor: EL (ELM = 1), SD (SDM = 0, SDLT = 0), ORG>

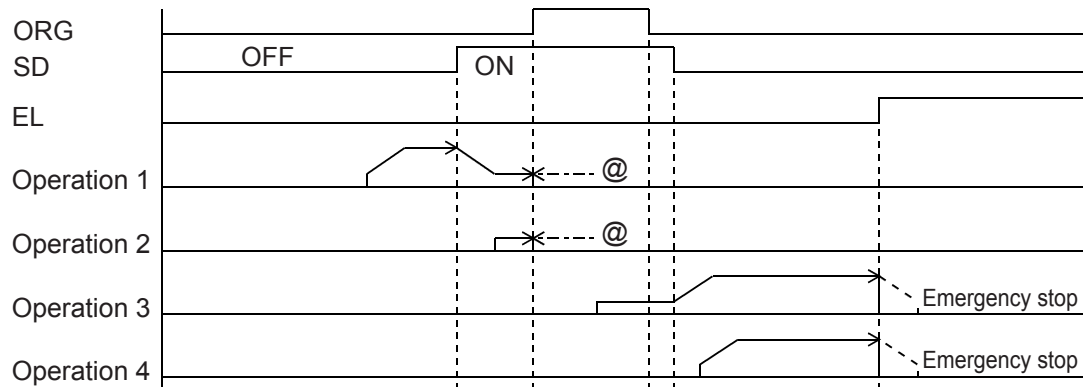

Note: Positions marked with "@" reflect the ERC signal output timing when "Automatically output an ERC signal" is selected for the zero stopping position.

9-5-1-2. Zero return operation 1 (ORM=0001)

Low speed operation <Sensor: EL (ELM = 0), ORG>

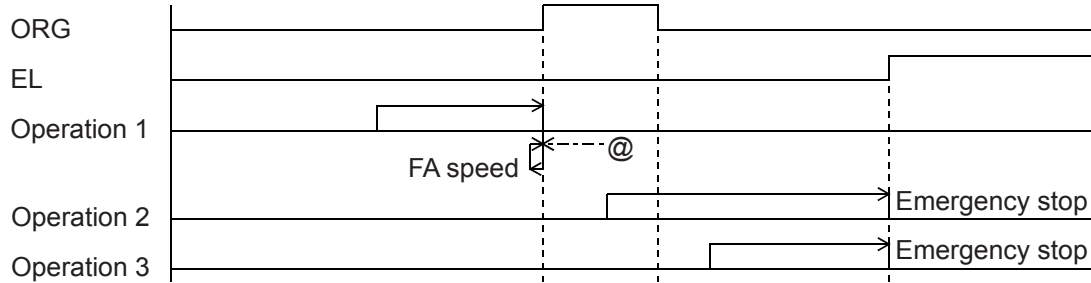

High speed operation <Sensor: EL, ORG>

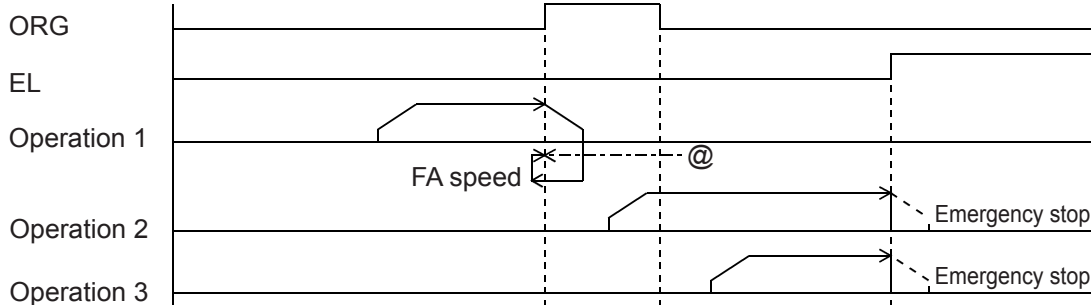

9-5-1-3. Zero return operation 2 (ORM = 0010)

Low speed operation <Sensor: EL (ELM = 0), ORG, EZ (EZD = 0001)>

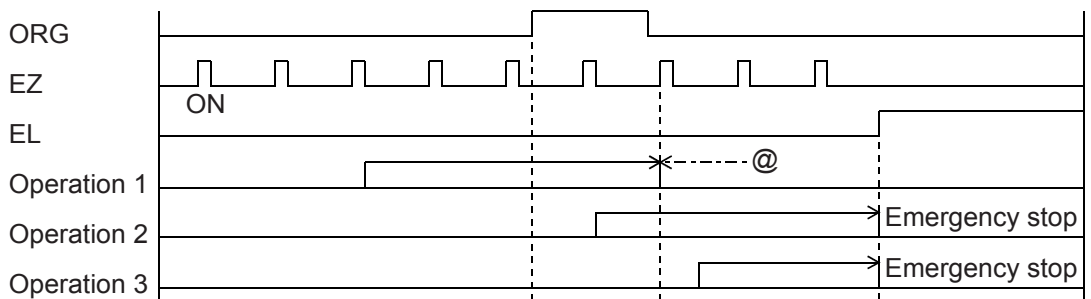

High speed operation <Sensor: EL, ORG, EZ (EZD = 0001)>

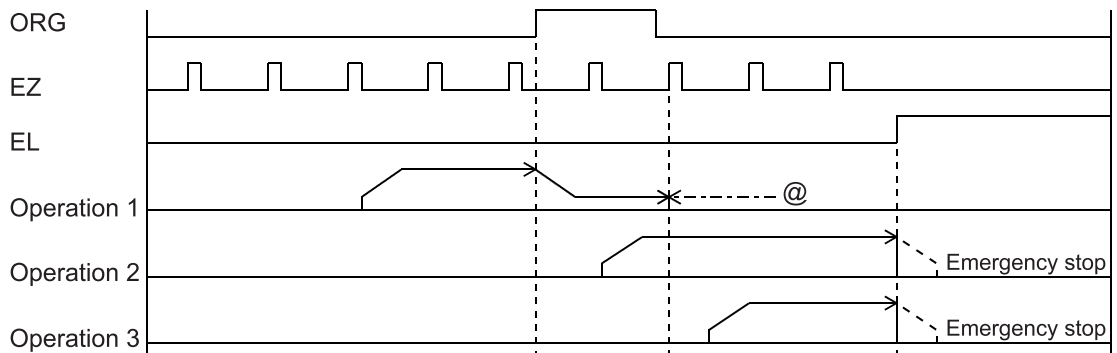

Note: Positions marked with "@" reflect ERC signal output timing when "Automatically output an ERC signal" is selected for the zero stopping position.

9-5-1-4. Zero return operation 3 (ORM = 0011)

Low speed operation <Sensor: EL, ORG, EZ (EZD = 0001)>

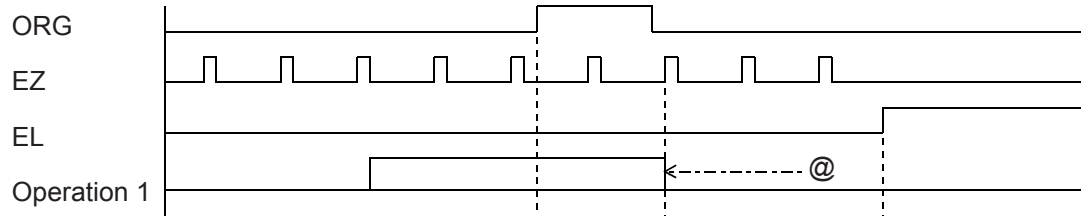

High speed operation <Sensor: EL, ORG, EZ (EZD = 0001)>

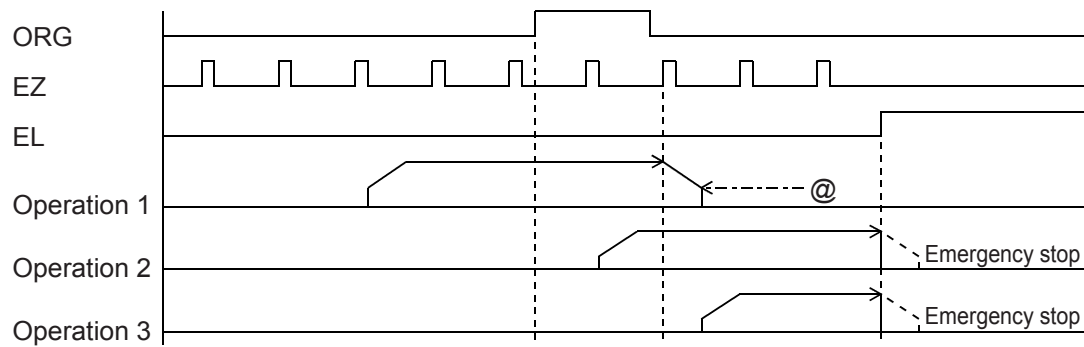

9-5-1-5. Zero return operation 4 (ORM = 0100)

Low speed operation <Sensor: EL, ORG, EZ (EZD = 0001)>

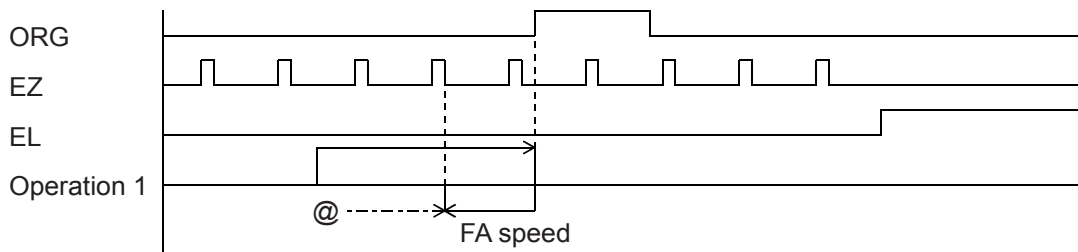

High speed operation <Sensor: EL, ORG, EZ (EZD = 0001)>

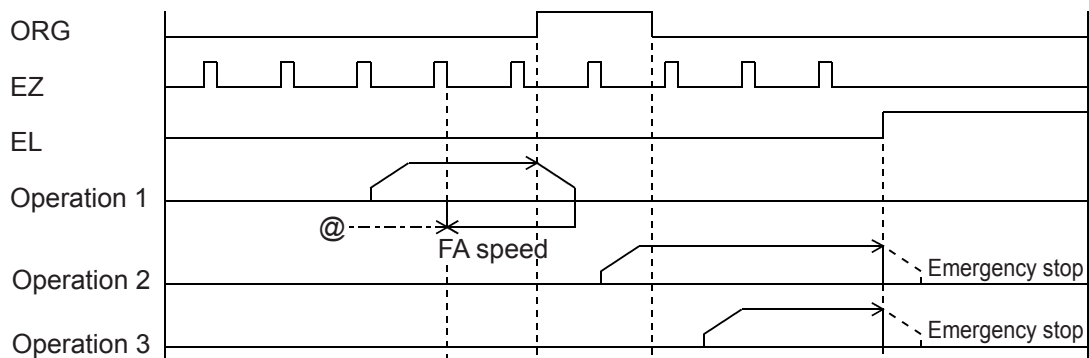

Note: Positions marked with "@" reflect the ERC signal output timing when "Automatically output an ERC signal" is selected for the zero stopping position.

9-5-1-6. Zero return operation 5 (ORM = 0101)

Low speed operation <Sensor: EL, ORG, EZ (EZD = 0001)>

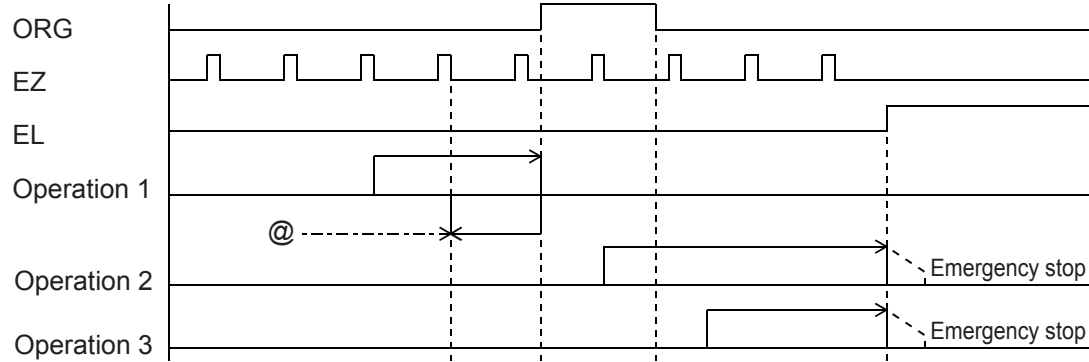

High speed operation <Sensor: EL, ORG, EZ (EZD = 0001)>

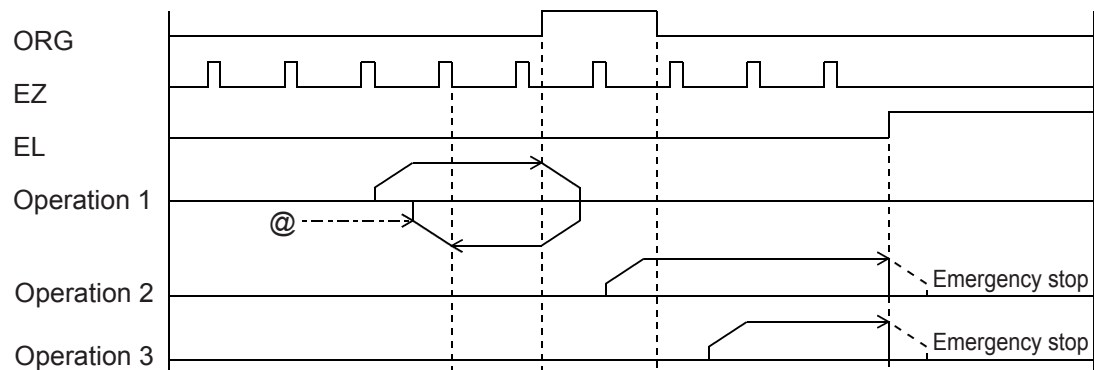

9-5-1-7. Zero return operation 6 (ORM = 0110)

Low speed operation <Sensor: EL>

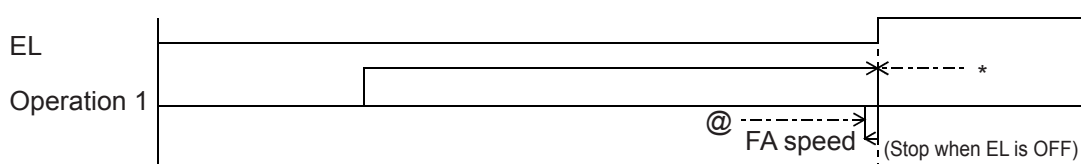

High speed operation <Sensor: EL>

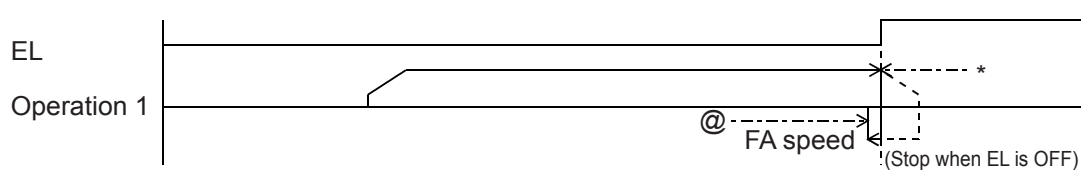

Note: Positions marked with "@" reflect the ERC signal output timing when "Automatically output an ERC signal" is selected for the zero stopping position.
Also, when EROE (bit 10) is 1 in the RENV1 register and ELM (bit 3) is 0, the LSI will output an ERC signal at positions marked with an asterisk (*).

9-5-1-8. Zero return operation 7 (ORM = 0111)

Low speed operation <Sensor: EL, EZ (EZD = 0001)>

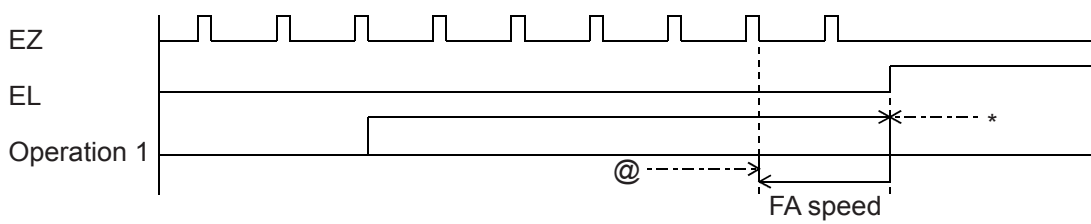

High speed operation <Sensor: EL, EZ (EZD = 0001)>

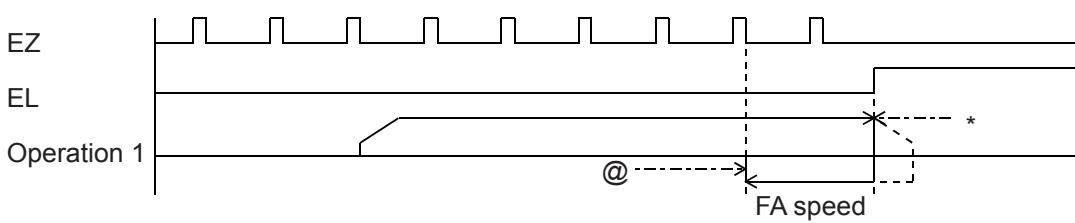

9-5-1-9. Zero return operation 8 (ORM=1000)

Low speed operation <Sensor: EL, EZ (EZD = 0001)>

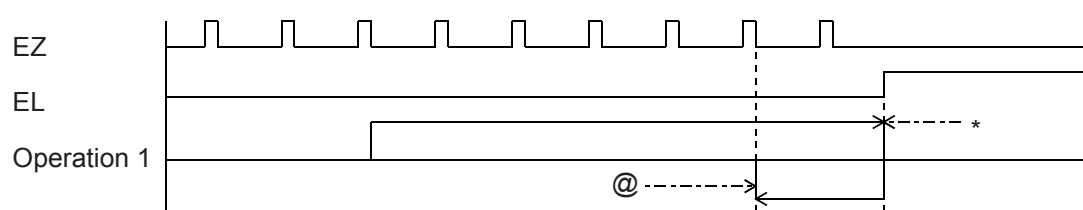

High speed operation <Sensor: EL, EZ (EZD = 0001)>

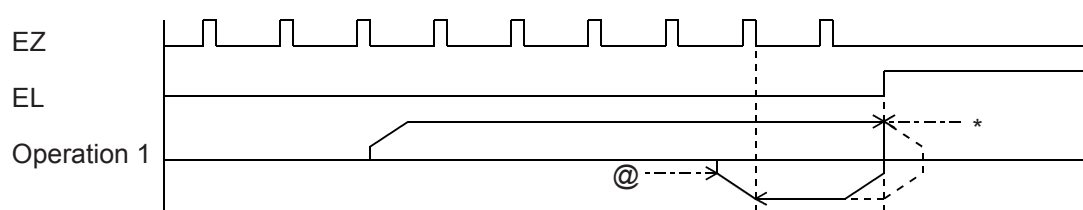

9-5-1-10. Zero return operation 9 (ORM = 1001)

High speed operation <Sensor: EL, ORG>

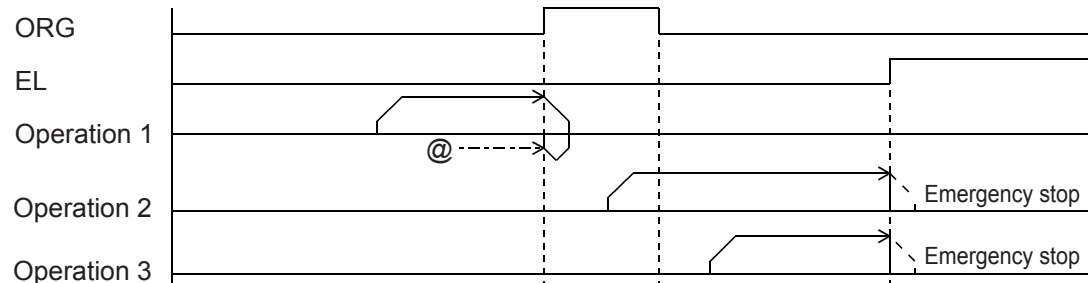

Note: Positions marked with "@" reflect the ERC signal output timing when "Automatically output an ERC signal" is selected for the zero stopping position.

Also, when EROE (bit 10) is 1 in the RENV1 register and ELM (bit 3) is 0, the LSI will output an ERC signal at positions marked with an asterisk (*).

9-5-1-11. Zero return operation 10 (ORM = 1010)

High speed operation <Sensor: EL, ORG, EZ (EZD = 0001)>

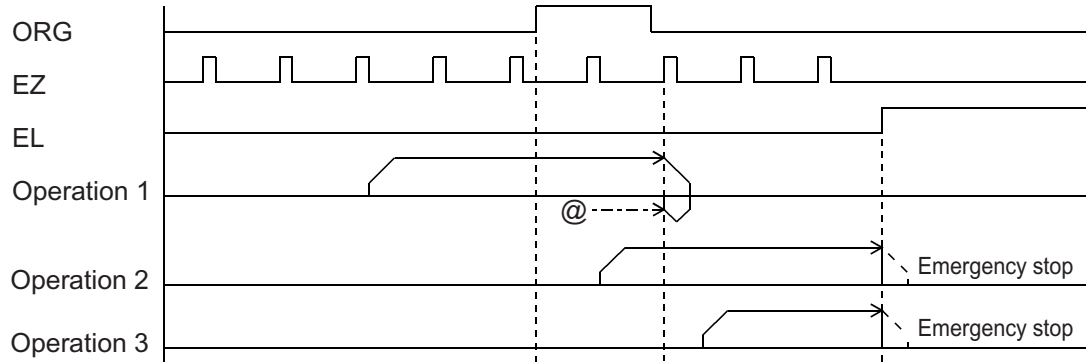

9-5-1-12. Zero return operation 11 (ORM = 1011)

High speed operation <Sensor: EL, ORG, EZ (EZD = 0001)>

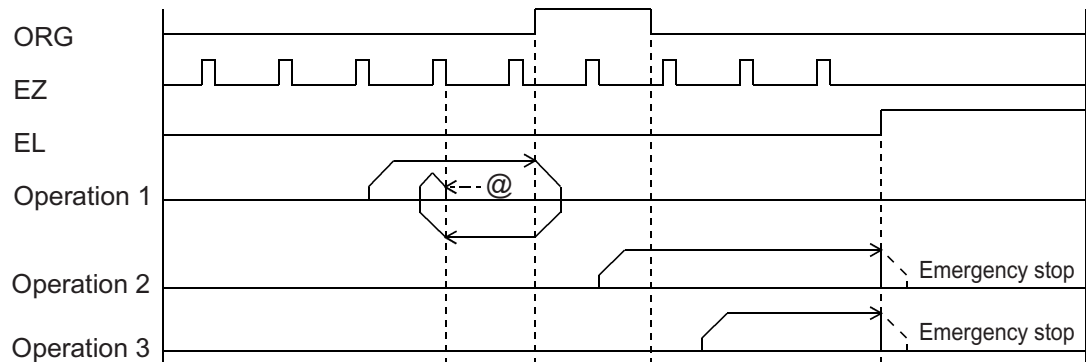

9-5-1-13. Zero return operation 12 (ORM = 1100)

High speed operation <Sensor: EL, EZ (EZD = 0001)>

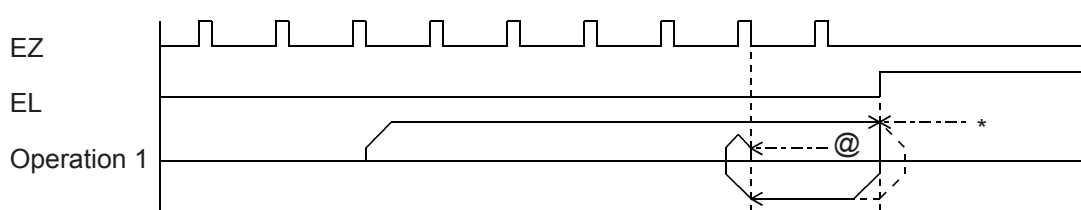

Note: Positions marked with "@" reflect the ERC signal output timing when "Automatically output an ERC signal" is selected for the zero stopping position.

Also, when EROE (bit 10) is 1 in the RENV1 register and ELM (bit 3) is 0, the LSI will output an ERC signal at positions marked with an asterisk (*).

9-5-2. Leaving the zero position operations

After writing a start command, the axis will leave the zero position (when the ORG input turns ON).

Make sure to use the "Low speed start command (50h, 51h)" when leaving the zero position.

When you write a start command while the ORG input is OFF, the LSI will stop the movement on the axis as a normal stop, without outputting pulses.

Since the ORG input status is sampled when outputting pulses, if the PCL starts at constant speed while the ORG signal is ON, it will stop operation after outputting one pulse, since the ORG input is turned OFF. (Normal stop)

MOD: 12h Leave the zero position in the positive direction

1Ah Leave the zero position in the negative direction

9-5-3. Zero search operation

This mode is used to add functions to a zero return operation. It consists of the following possibilities.

- 1) A "Zero return operation" is made in the opposite direction to the one specified.
- 2) A "Leaving the zero position using positioning operations" is executed in the opposite direction to the one specified.
- 3) A "Zero return operation" is executed in the specified direction.

Operation 1: If the ORG input is turned ON after starting, movement on the axis will stop normally.

Operation 2: If the ORG input is already turned ON when starting, the axis will leave the zero position using positioning operations, and then begin a "zero return operation."

Operation 3: If movement on the axis is stopped by an EL signal while operating in the specified direction, the axis will execute a "zero return operation (ORM = 0000)" and a "leaving the zero position by positioning" in the opposite direction. Then it will execute a "zero return operation" in the specified direction.

When "leaving the zero position by positioning," the axis will repeat the positioning operation for the number of pulses specified in the RMV (target position) register, until the zero position has been left. Enter a positive number (1 to 134,217,727) in the RMV register.

MOD: 15h Zero search operation in the positive direction

1Dh Zero search operation in the negative direction

9-5-3-1. Zero return operation 0 (ORM=0000)

Low speed operation <Sensor: EL, ORG>

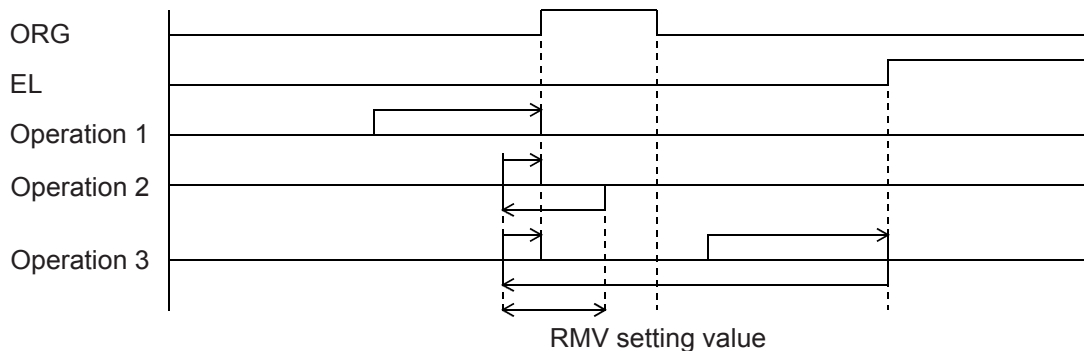

High speed operation <Sensor: EL, ORG>

Even if the axis stops normally, it may not be at the zero position. However, COUNTER2 (mechanical position) provides a reliable value.

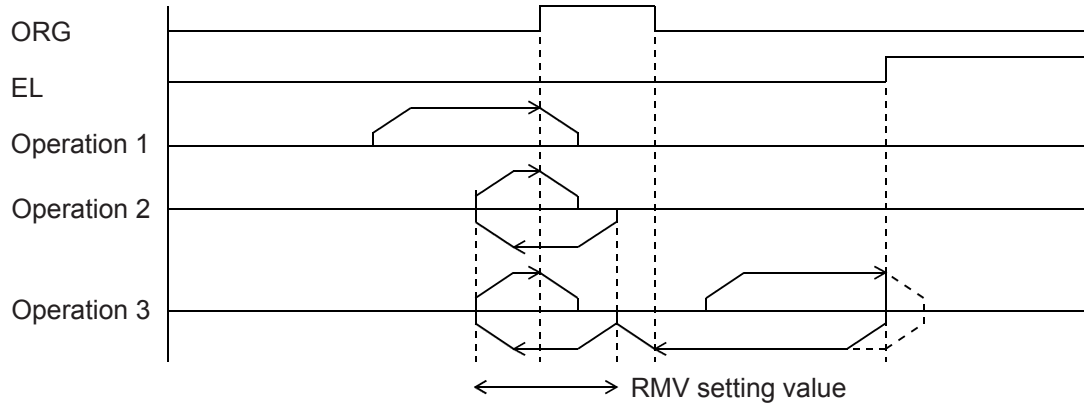

9-6. EL or SL operation mode

The following four modes of EL or SL (soft limit) operation are available.

MOD	Operation mode	Direction of movement
20h	Operate until reaching the +EL or +SL position.	Positive direction
28h	Operate until reaching the -EL or -SL position.	Negative direction
22h	Leave from the -EL or -SL positions.	Positive direction
2Ah	Leave from the +EL or +SL positions.	Negative direction

To specify the \pm EL input signal, set the input logic using the ELL input terminal. Select the operation type (immediate stop / deceleration stop) when the input from that terminal is ON in the RENV1 (Environment setting 1) register. The status of the terminal can be monitored using the SSTSW (sub status) register. For details about setting the SL (software limit), see section 11-11-2, "Software limit function."

Select the \pm EL signal input logic <ELL input terminal> L: Positive logic input H: Negative logic input	
Select the stop method to use when the \pm EL signal is turned ON <Set ELM (bit 3) in RENV1> 0: Stop immediately when the \pm EL signal turns ON. 1: Decelerates and stops when the \pm EL signal turns ON.	[RENV1] (WRITE) 7 0 - - - - n - - -
Reading the \pm EL signal <SPEL (bit 12), SMEL (bit 13) in SSTSW> SPEL=0: Turn OFF +EL signal SPEL=1: Turn ON +EL signal SMEL=0: Turn OFF -EL signal SMEL=1: Turn ON -EL signal	[SSTSW] (READ) 15 8 - - n n - - - -
Setting the \pm EL input filter <Set the FLTR (bit 26) in RENV1 > 1: Apply a filter to the \pm EL input. After applying a filter, signals shorter than 4 μ sec will be ignored.	[RENV1] (WRITE) 31 24 - - - - - n - -

9-6-1. Feed until reaching an EL or SL position

This mode is used to continue feeding until the EL or SL (soft limit) signal is turned ON and then the operation stops normally.

When a start command is written on the position where the EL or SL signal is turned ON, the LSI will not output pulses and it will stop the axis normally. When a start command is written to the axis while the EL and SL signals are OFF, the axis will stop when the EL or SL signal is turned ON. (Normal stop.)

MOD: 20h Feed until reaching the +EL or +SL position.

28h Feed until reaching the -EL or -SL position.

9-6-2. Leaving an EL or SL position

This mode is used to continue feeding until the EL or SL (software limit) signal is turned OFF.

When a start command is written on the position where the EL and SL signals are turned OFF, the LSI will not output pulses and it will stop the axis normally.

When starting an operation while the EL input or SL signal is ON, the PCL will stop operation normally when both the EL input and SL signal are OFF.

MOD: 22h Leave from a -EL or -SL position

2Ah Leave from a + EL or +SL position

9-7. EZ count operation mode

This mode is used to count EZ signal of the number (EZD set value +1) written into the RENV3 register.

MOD: 24h Feed until the EZ count is complete in positive direction.

2Ch Feed until the EZ count is complete in negative direction.

After a start command is written, the axis stops immediately (or decelerates and stops when feeding at high speed) after the EZ count equals the number stored in the register.

The EZ count can be set from 1 to 16.

Use the low speed start command (50h, 51h) for this operation. When the high speed start command is used, the axis will start decelerating and stop when the EZ signal turns ON, so that the motion on the axis overruns the EZ position.

Specify logical input for the EZ signal in the RENV2 (environment setting 2) register, and the EZ number to count to in the RENV3 (environment setting 3) register. The terminal status can be monitored by reading the RSTS (extension status) register.

Setting the input logic of the EZ signal 0: Falling edge 1: Rising edge	<Set EZL (bit 23) in RENV2>	[RENV2] (WRITE) 23 16 n - - - - -
Setting the EZ count number RENV3> Specify the EZ count number after a zero return complete condition. Enter a value (the number to count to minus 1) in EZD 0 to 3. Setting range: 0 to 15.	<Set EZD0 to 3 (bits 4 to 7) in RENV3>	[RENV3] (WRITE) 7 0 n n n n - - - -
Reading the EZ signal 0: Turn OFF the EZ signal 1: Turn ON the EZ signal	< SEZ (bit 10) in RSTS>	[RSTS] (READ) 15 8 - - - - - n - -

9-8. Interpolation operations

9-8-1. Interpolation operations

In addition to each independent operation, this LSI can execute the following interpolation operations.

MOD	Operation mode
60h	Continuous linear interpolation 1 for 2 to 4 axes
61h	Linear interpolation 1 for 2 to 4 axes
62h	Continuous linear interpolation 2 for 1 to 4 axes
63h	Linear interpolation 2 for 1 to 4 axes
64h	Circular interpolation (CW)
65h	Circular interpolation (CCW)
66h	CW circular interpolation synchronized with the U axis

MOD	Operation mode
67h	CCW circular interpolation synchronized with the U axis.
68h	Continuous linear interpolation 1 synchronized with PA/PB input
69h	Linear interpolation 1 synchronized with PA/PB input
6Ah	Continuous linear interpolation 2 synchronized with PA/PB input.
6Bh	Linear interpolation 2 synchronized with PA/PB input
6Ch	CW circular interpolation synchronized with PA/PB input
6Dh	CCW circular interpolation synchronized with PA/PB input

Continuous linear interpolation is the same as the linear interpolation used to feed multiple axes at specified rates, and to start and stop feeding using commands such as the continuous mode commands. Interpolation 1 executes an interpolation operation between any two to four axes in the LSI.

Interpolation 2 is used to control five axes or more using more than one LSI, and to control feeding using linear interpolation.

Independent operation of the un-interpolated axes is also possible.

The interpolation settings and operation status can be monitored by reading the RIPS (interpolation status) register.

The RIPS register is shared by the X and Y axes. Reading from any axis will return the identical information.

Write start and stop commands to both axes by setting SELx and SELy in COMB1.

[Interpolation operations that can be combined with this LSI]

- 1) Linear interpolation 1 of two axes.
- 2) Linear interpolation 1 of three axes.
- 3) Linear interpolation 1 of four axes.
- 4) Circular interpolation of two axes
- 5) Linear interpolation 1 of two axes and circular interpolation of two axes

Axes that are not involved in one of the interpolation operations 1) to 5) above, can be operated independently or can be used to execute a linear interpolation 2.

9-8-2. Interpolation control axis

In Circular interpolation and Linear interpolation 1, specify the speed for one axis only. This axis is referred to as the interpolation control axis. Interpolation control axes can only be in the order X, Y, Z, and U for the axes that are interpolated.

When you want to execute both an circular interpolation and a linear interpolation simultaneously, there will be two interpolation control axes.

When linear interpolation 2 is selected, each axis will be used to control the interpolation.

[Relationship between an interpolation operation and the axes used for interpolation control]

No	Interpolation operation	Interpolation control axis
1)	Linear interpolation 1 of the X, Y, Z, and U axes.	X axis
2)	Linear interpolation 1 of the X, Y, and Z axes.	X axis
3)	Linear interpolation 1 of the Y, Z, and U axes.	Y axis
4)	Linear interpolation 1 of the Y and U axis	Y axis
5)	Circular interpolation of the X and U axis	X axis
6)	Circular interpolation of the X and Z axes, and linear interpolation 1 of the Y and U axes	Circular interpolation: X axis Linear interpolation 1: Y axis

9-8-3. Constant synthesized speed control

This function is used to create a constant synthesized speed for linear interpolation 1 and circular interpolation operations. When linear interpolation 2 is selected, this function cannot be used. To enable this function, set the MIPF (bit 15) in the PRMD (operation mode) register to "1" for the axes that you want to have a constant synthesized speed. When the same interpolation mode is selected, the axes whose MIPF bit is set to "1" will have a longer pulse output interval: multiplied by the square root of two ($\sqrt{2}$) for two axis simultaneous output, and by the square root of three ($\sqrt{3}$) for three axis simultaneous output.

For example, when applying linear interpolation 1 to the X, Y, and Z axes, and only the Y and Z axes have the MIPF bit = 1, the interval before a pulse output on another axis after simultaneous pulse output on the Y and Z axes will be multiplied by the $\sqrt{2}$. When X and Y, or X and Z output pulses at the same time, the interval until the next pulse output will not change.

The synthesized constant speed control can only be used for 2 or 3 axes. When applying linear interpolation 1 to four axes, if MIPE = 1 for all four axes, and if all four axes output pulses at the same time, the interval will also be multiplied by the $\sqrt{3}$.

When the synthesized constant speed control bit is turned ON (MIPF = 1), the synthesized speed (while performing interpolation) will be the operation speed (PRFH) or the initial speed (PRFL) of the interpolated axes.

SRUN, SEND, and SERR in MSTSW (main status byte) for the interpolated axis will change using the same pattern.

The RSPD (speed monitor) feature is only available for the interpolation control axes. However, when linear interpolation 2 is used, the value read out will be the main axis speed.

<Precautions for using the composite constant speed control bit (MIPF = 1)>

1) Positioning is only possible at the unit's resolution position for machine operation.

Therefore, even if an interpolation operation is selected, the machine will use the following points to approximate an arc, and the actual feed pattern will be point to point (zigzag feeding). With this feed pattern, the actual feed amount will be longer than the ideal linear line or an ideal arc. The function of the synthesized constant speed control in this LSI is to make constant synthesized speeds for multiple axes in simultaneous operation, which means that the speed through the ideal locus (trajectory) will not be constant.

For example, with linear interpolation in the figure on the right (using the synthesized constant speed feature), the PCL will make a constant synthesized speed in order to feed at a 45° angle by decreasing the speed to $1/\sqrt{2}$.

Therefore, the feeding interval when the feed speed is 1 pps will be $6 + 4\sqrt{2} = 11.66$ seconds.

The length of the ideal line (dotted line) is $\sqrt{(10^2+4^2)} = 10.77$. If the machine can be fed by just following the ideal line, the feed interval will be 10.77 seconds.

Please take note of the above when using synthesized constant speed control.

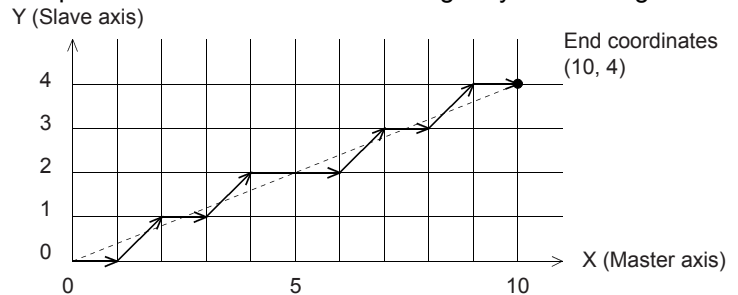

2) Acceleration/deceleration operations when the synthesized constant speed control bit is ON (MIPF = 1) Basically, the operation will have a constant speed when MIPF = 1. (The synthesized speed will vary with the acceleration/deceleration.)

When MIPF = 1 and you select linear interpolation 1 or circular interpolation with acceleration/deceleration, the following limitations apply.

- Make the acceleration rate (PRUP) and deceleration rate (PRDR) for the control axes equal.
- Do not change the speed during S-curve acceleration/deceleration.

Failure to follow these guidelines may cause the PCL to decelerate abnormally.

9-8-4. Continuous linear interpolation 1 (MOD: 60h)

This is the same as linear interpolation 1, and each axis operates at a speed corresponding to the PRMV setting. However, the PCL will continue to output pulses until a stop command is received. This mode only uses the rate from the PRMV setting for all of the interpolated axes. Therefore, if the PRMV setting for the all of the interpolated axes is zero, the PCL will output pulses to all the interpolated axes at the same speed.

9-8-5. Linear interpolation 1 (MOD: 61h)

Linear interpolation 1 is used to allow a single LSI to provide interpolation operations between any 2 to 4 axes.

If only one axis is specified and operation is started, an error (ESDT: Stop due to operation data error) will occur.

After setting the operation speed for the interpolation control axes, specify whether to use or not the synthesized constant speed control in the PRMD registers, or specify an end point position in the PRMV register for all of the interpolated axes.

The direction of operation is determined by the sign of the value in the PRMV register.

Automatically, the axis with the maximum feed amount (maximum absolute value in the PRMV register) will be considered the master axis. The other axis will be the slave axis.

When a start command is written, the LSI will output pulses to the master axis and the slave axis will be supplied a smaller number of pulses than the master axis. Write a start command by setting either the SELx or SELy bits corresponding to the interpolation axes in COMB1 to 1. Writing any of these axes bring the same result.

[Setting example] Use the settings below and write a start command (0751h). The PCL will output pulses with the timing shown in the figure below. Entering values in the blank items will not affect operation.

Setting	X axis	Y axis	Z axis
MOD	61h	61h	61h
MIPF	0 (OFF)	0 (OFF)	0 (OFF)
RMV value	5	10	2
Operation speed	1000 pps		
Interpolation control axis	0		
Master axis / slave axis	Slave axis	Master axis	Slave axis

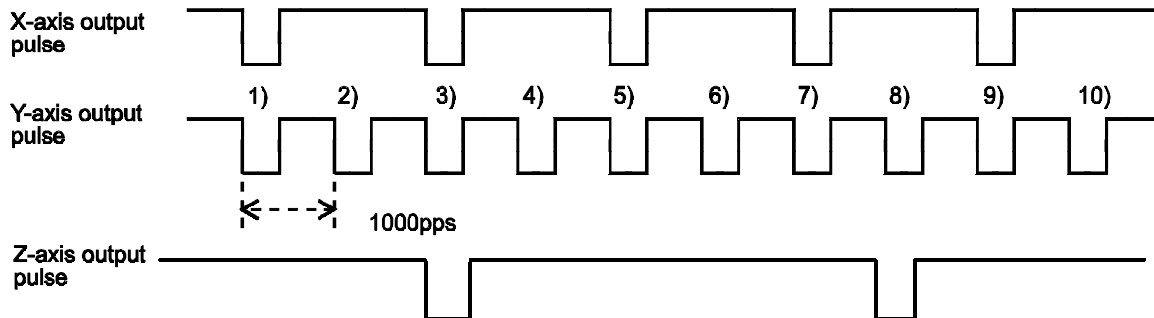

[Precision of linear interpolation]

As shown in the figure on the right, linear interpolation executes an interpolation from the current coordinates to the end coordinates. The positional precision of a specified line during linear interpolation will be ± 0.5 LSB throughout the interpolation range. "LSB" refers to the minimum feed unit for the PRMV register setting. It corresponds to the resolution of the mechanical system. (distance between tick marks in the figure on the right.)

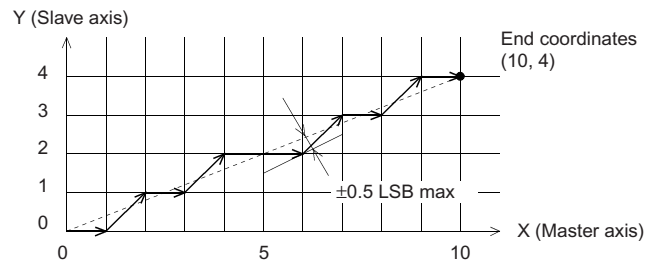

9-8-6. Continuous linear interpolation 2 (MOD: 62h)

Same as Linear Interpolation 2: the PCL controls each axis using speeds that correspond to the ratios of the values set in PRIP and PRMV. However, in continuous mode the PCL will continue to output pulses until it receives a stop command.

9-8-7. Linear interpolation 2 (MOD: 63h)

Linear interpolation 2 is used for linear interpolations between 5 or more axes and uses more than one LSI for control.

In this mode, the PCL cannot synchronize the acceleration/deceleration timing between interpolated axes, so this mode cannot be used with acceleration/deceleration.

In order to execute a linear interpolation using multiple LSIs, you must use a simultaneous start signal ($\overline{\text{CSTA}}$ signal).

For details about the $\overline{\text{CSTA}}$ signal, see section 11-7, "External start, simultaneous start."

The axis with the maximum amount to be fed is referred to as the master axis during the interpolation and the other axes are slave axes.

Enter the PRMV register setting for the master axis in the RIP registers of each axis (including the master axis).

In the PRMV registers of the slave axes, enter end point of each axis.

Specify the speed data (PRFL, PRFH, PRUR, PRDR, PRMG, PRDP, PRUS, and PRDS) for the slave axes to be the same as for the master axis.

The feed direction is determined by the sign of the value in the PRMV register.

After writing "01" into MSY (bits 18 and 19) in the PRMD (operation mode) register of the axes, write a start command and set the axes to wait for the $\overline{\text{CSTA}}$ signal input. By entering a $\overline{\text{CSTA}}$ signal, all of the axes on all of the LSIs will start at the same time.

The master axis provides pulses constantly. The slave axes provide some of the pulses fed to the master axis, but some are omitted.

[Setting example]

- 1) Connect the $\overline{\text{CSTA}}$ signals between LSI-A and LSI-B.
- 2) Set up the LSIs as shown below. (Set the PRMD to start with an $\overline{\text{CSTA}}$ input.)
- 3) Write start commands (LSI-A: 0951h, LSI-B: 0651h).
- 4) Write a $\overline{\text{CSTA}}$ signal input command (06h) to the X axis on LSI-A.

After completing steps 1) to 4) above, the LSIs will output pulses using the timing shown in the figure below.

Setting	LSI-A		LSI-B	
	X axis	Y axis	Y axis	Z axis
RMD	0004 0063h	0004 0063h	0004 0063h	0004 0063h
RMV value	8	5	2	10
RIP value	10	10	10	10
Operation speed	1000 pps	1000 pps	1000 pps	1000 pps
Master axis / slave axis	Slave axis	Slave axis	Slave axis	Master axis

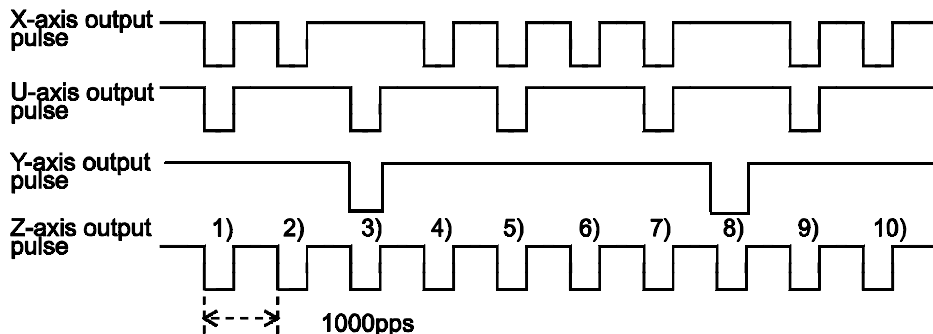
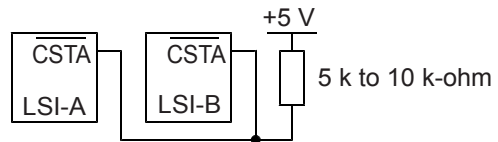

Note: If you start linear interpolation 2 while PRIP = 0, an operation data error (ESDT of RESET is "1") will occur.

9-8-8. Circular interpolation

This function provides CW circular interpolation (MOD: 64h) and CCW circular interpolation (MOD: 65h) between the X and Y axes.

If only one axis or 3 to 4 axis is specified for circular interpolation and a start command is written, a data setting error will occur.

Circular interpolation takes the current position as the starting point (coordinate 0, 0) regardless of the values in the counters (COUNTER1 to 4).

After specifying the speed for each axis being interpolated, specify whether or not to apply constant synthetic speed control (MIPF in the PRMD register) for each axis, the end points (the PRMV register value), and the center point (the PRIP register value). If the end point is 0 (the starting point), both axes will draw a simple circle.

The synthetic speed used in the circular interpolation will be the speed set for the axes being interpolated (FH/FL) if the constant synthetic speed control is ON (MIPF = 1) for both axes.

Write a start command after setting SELx and SELy in COMB1 to 1. Either axis can be used to write a start command.

[Setting example]

As shown in the table below, specify the MOD, MIPF, PRMV, PRIP and operation speed for each axis and write a start command (ex. 0351h) that will be used by both axes. The axes will move as shown on the right.

Step No. Set value	A		B		C		D	
	X axis	Y axis	X axis	Y axis	X axis	Y axis	X axis	Y axis
MOD	64h (CW circular interpolation)							
MIPF	1 (turn ON constant synthetic speed control)							
PRMV value	0	0	100	100	200	0	100	-100
PRIP value	100	0	100	0	100	0	100	0
Operation result	Simple circle		90° arc		180° arc		270° arc	

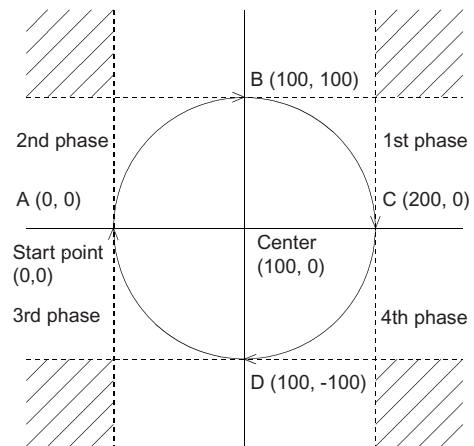

This LSI terminates a circular interpolation operation when either of the axes reaches the end point in the last quadrant, and the end point can be specified as the whole number coordinates nearest to the end position. For this reason, even though the circular interpolation operation is complete, the PCL will not be at the end coordinate specified. To move to the coordinates of the specified end point when the circular interpolation operation is complete, set the MPIE bit in the PRMD register to "1" and turn ON the end point draw function. If the end point of the circular interpolation is set within the shaded areas, the axes will not stop moving (perpetual circular motion).

[Circular interpolation precision]

The circular interpolation function draws a circular from the current position to the end coordinate moving CW or CCW. The positional deviation from the specified curve is ± 0.5 LSB. The figure on the right is an example of how to draw a simple circle with a radius of 11 units.

The LSB refers the minimum feeding unit of the PRMV register setting value. It corresponds to the resolution of mechanical system (size of the cells in the figure right.)

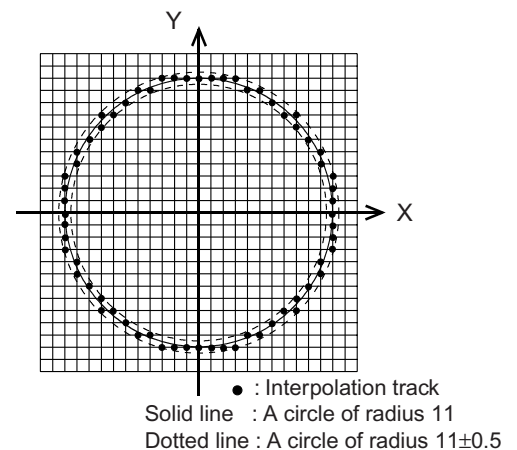

[Circular interpolation with acceleration/deceleration]

To use circular interpolation with acceleration/deceleration, you have to enter the number of circular interpolation pulses required (circular interpolation step numbers) in the PRCI register for the control axis.

To calculate the number of pulses required for circular interpolation, break the area covered by the X and Y axes into 8 (0 to 7) sections, using the center coordinate of the circular interpolation as the center point. See the figure below.

The output pulse status of each axis in each area is as follows

Area	X axis output pulse	Y axis output pulse
0	Output according to the interpolation calculation result	Always output
1	Always output	Output according to the interpolation calculation result
2	Always output	Output according to the interpolation calculation result
3	Output according to the interpolation calculation result	Always output
4	Output according to the interpolation calculation result	Always output
5	Always output	Output according to the interpolation calculation result
6	Always output	Output according to the interpolation calculation result
7	Output according to the interpolation calculation result	Always output

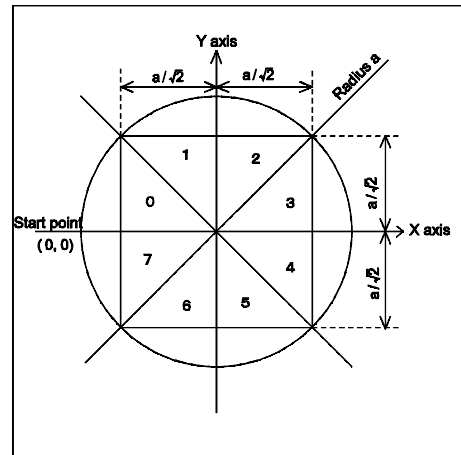

The table above shows the PCL output pulses for either of the axes in each area.

Therefore, the number of pulses required for circular interpolation (the number of circular interpolation steps) is equal to the number of pulses to move around this side of a square that is surrounded by the circle used for the circular interpolation.

For example, to draw a 90° arc with radius "a," the number of pulses required for circular interpolation will be $(a\sqrt{2}) \times 2$. Enter this value in the PRCI register.

To obtain the number of steps for any start and end points, follow the procedure below.

- 1) First, determine the area that the start point belongs to (area 0 to 7). Then, draw a horizontal (vertical) line to find the contact point with the square inside the circle.
- 2) Next, determine the area that the end point belongs to (area 0 to 7). Then, draw a vertical (horizontal) line to find the contact point with the square inside the circle.
- 3) Find the distance between the two contact points on the square (from 1) and 2) above) and enter this value in the PRIC register.

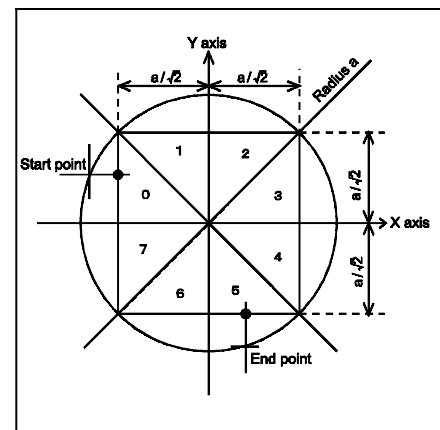

To continue the end point draw function, set MPIE in the PRMD register to "1." Then enter the value in the PRCI register after adding number of pulses required for the end point draw function.

Note 1: The PRCI register value is used to trigger the start of the deceleration timing. When a smaller value is entered, the PCL will start deceleration sooner and the FL constant time will apply. When a larger value is entered, the PCL will delay the beginning of deceleration and then will have to stop suddenly. However, the interpolation trajectory is equal to the constant speed circular interpolation.

Note 2: To specify a ramp down point manually, think of the PRCI setting as a number of output pulses, so that the PRDP calculation formula for the positioning operation can be used. However, this formula cannot be used when the synthesized constant speed operation is ON. In this case, there is no other way to obtain a ramp down point except by changing the RICV value and conducting a test.

9-8-9. Circular interpolation synchronized with the U axis

By synchronizing with the U axis, any two axes can be used for CW circular interpolation (MOD: 66h) or CCW circular interpolation (MOD: 67h).

If you specify circular interpolation for one axis or for 3 to 4 axes, and try to start the operation, the PCL will declare a data setting error.

When the U axis positioning counter (RPLS) reaches 0 while starting or during an circular interpolation, the PCL will also declare a data setting error.

By simultaneously using linear interpolation, the PCL can synchronize one axis while performing a circular interpolation on two other axes. This function can be used for things like a circular interpolation between the X and Y axes and to adjust the angle of a jig toward an arc tangent point with the Z axis. Also, in this operation the U axis operation will be a dummy motion and it cannot be used for any other purpose.

<Conceptual figure>

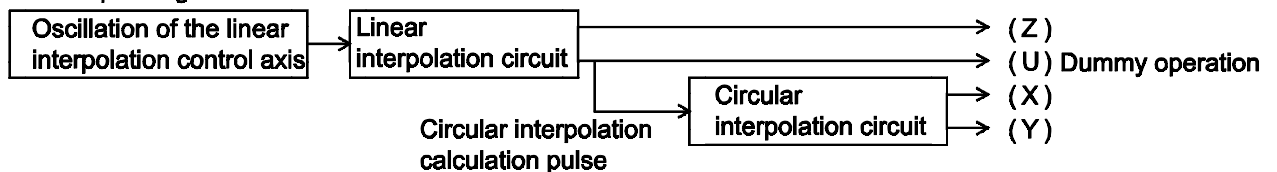

Using the operation above, set the operation mode (RMD) for the X and Y axes to 66H (67h), and set the Z and U axes to 61h.

Enter the number of circular interpolation steps in the PRMV register for the U axis.

For details about how to obtain the number of circular interpolation steps, see the discussion of "circular interpolation with acceleration/deceleration" in the previous section.

To write a start or stop command, make all the bits in SELx to SELu of the COMB1 register equal to "1." Any axis can be used to write "1."

9-8-10. Interpolation operation synchronized with PA/PB

This function uses the PA/PB input signal (after magnification or division) instead of the internal clock. Any PA/PB input after the interpolation operation is complete will be ignored.

9-8-11. Operation during interpolation

◆ Acceleration/deceleration operations

Acceleration and deceleration (linear and S-curve) can be used with Linear interpolation 1 and circular interpolation operations.

Please note the following limitations.

- 1) Set the MSDP and MADJ in the PRMD register the same for all of the interpolated axes.
- 2) When MIPF = 1 and MSDP = 0 in the PRMD register, if the PRDP register is set to "-1" it will make a small deviation in the ramp down point.
- 3) During circular interpolation, the FH correction function will be disabled.

4) When circular interpolation is selected with S-curve acceleration/deceleration, the PRUS and PRDS register values cannot be set to zero (auto).

To control the ramp down point while using linear interpolation¹, the PCL executes a comparison of RPLS and RSDC for the longest axis. The RSDC setting for any shorter axes will be invalid. However, if more than one axis has the same length and they are the longest axes, to specify a ramp down point manually you must enter the same value for all of the interpolated axes.

To control the ramp down point while using circular interpolation, the PCL executes a comparison of CIC and RSDC on the control axis. Therefore, to specify a ramp down point manually, write to RSD on the control axis.

- ◆ Error stop
If any of the axes stops with an error, all of the axes being interpolated will stop (SERR = 1). By reading the REST (error stop cause) register, you can determine which axis actually stopped with an error.
- ◆ SD input
When SD input is enabled (MSDE (bit 8) in the RMD register is set to 1), and if the SD input turns ON either of the axes, both axes will decelerate or decelerate and stop.
- ◆ Idling control
If any axis is in idling range, none of the axes being interpolated will accelerate.
- ◆ Correction function
When phases are changed during circular interpolation, backlash correction and slip correction control cannot be used.
- ◆ Continuous interpolation
The PCL can use the pre-register to make a continuous linear interpolation or circular interpolation. However, when the axes being interpolated change during a continuous interpolation, requires special care.
An example of the settings for continuous interpolation using the pre-register is shown in section 11-14-1, "Start triggered by a stop on another axis."

10. Speed patterns

10-1. Speed patterns

Speed pattern	Continuous mode	Positioning operation mode
<p>FL low speed operation</p>	<p>1) Write an FL low speed start command (50h).</p> <p>2) Stop feeding by writing an immediate stop (49h) or deceleration stop (4Ah) command.</p>	<p>1) Write an FL low speed start command (50h).</p> <p>2) Stop feeding when the positioning counter reaches zero, or by writing an immediate stop (49h) or deceleration stop (4Ah) command.</p>
<p>FH low speed operation</p>	<p>1) Write an FH low speed start command (51h).</p> <p>2) Stop feeding by writing an immediate stop command (49h).</p>	<p>1) Write an FH low speed start command (51h).</p> <p>2) Stop feeding when the positioning counter reaches zero, or by writing an immediate stop (49h) command.</p>
<p>* When the deceleration stop command (4Ah) is written to the register, the PCL starts deceleration.</p>		
<p>High speed operation 1)</p>	<p>1) Write high speed start command 1 (52h).</p> <p>2) Start deceleration by writing a deceleration stop command (4Ah).</p> <p>* When the deceleration stop command (49h) is written to the register, the PCL immediately stops</p> <p>* When idling pulses are added by setting IDL in RENV5 to a non-zero value, after outputting idling pulses at FL speed, the PCL will accelerate to FH speed.</p>	<p>1) Write high speed start command 1 (52h).</p> <p>2) Start deceleration when a ramping-down point is reached or by writing a deceleration stop command (4Ah).</p> <p>* When positioning with a high speed start command 1 (52h), <u>the ramping-down point is fixed to the manual setting</u>, regardless of the setting for MSDP (bit 13) in the PRMD. If the ramping-down point setting (PRDP) is zero, the axis will stop immediately.</p>
<p>High speed operation 2)</p>	<p>1) Write high speed command 2 (53h).</p> <p>2) Start deceleration by writing a deceleration stop command (4Ah).</p> <p>* When the deceleration stop command (49h) is written to the register, the PCL starts deceleration.</p>	<p>1) Write high speed start command 2 (53h).</p> <p>2) Start deceleration when a ramping-down point is reached or by writing a deceleration stop command (4Ah).</p> <p>* If the ramping-down point is set to manual (MSDP = 1 in the PRMD), and the ramping-down value (PRDP) is zero, the axis will stop immediately.</p>

10-2. Speed pattern settings

Specify the speed pattern using the registers (pre-registers) shown in the table below.

If the next register setting is the same as the current value, there is no need to write to the register again.

Pre-register	Description	Bit length setting range	Setting range	register
PRMV	Positioning amount	28	-134,217,728 to 134,217,727 (8000000h) (7FFFFFFh)	RMV
PRFL	Initial speed	16	1 to 65,535 (0FFFFh)	RFL
PRFH	Operation speed	16	1 to 65,535 (0FFFFh)	RFH
PRUR	Acceleration rate	16	1 to 65,535 (0FFFFh)	RUR
PRDR	Deceleration rate Note 1	16	0 to 65,535 (0FFFFh)	RDR
PRMG	Speed magnification rate	12	2 to 4,095 (0FFFh)	RMG
PRDP	Ramping-down point	24	0 to 16,777,215 (0FFFFFFh)	RDP
PRUS	S-curve acceleration range	15	0 to 32,767 (7FFFh)	RUS
PRDS	S-curve deceleration range	15	0 to 32,767 (7FFFh)	RDS

Note 1: If PRDR is set to zero, the deceleration rate will be the value set in the RUR.

[Relative position of each register setting for acceleration and deceleration factors]

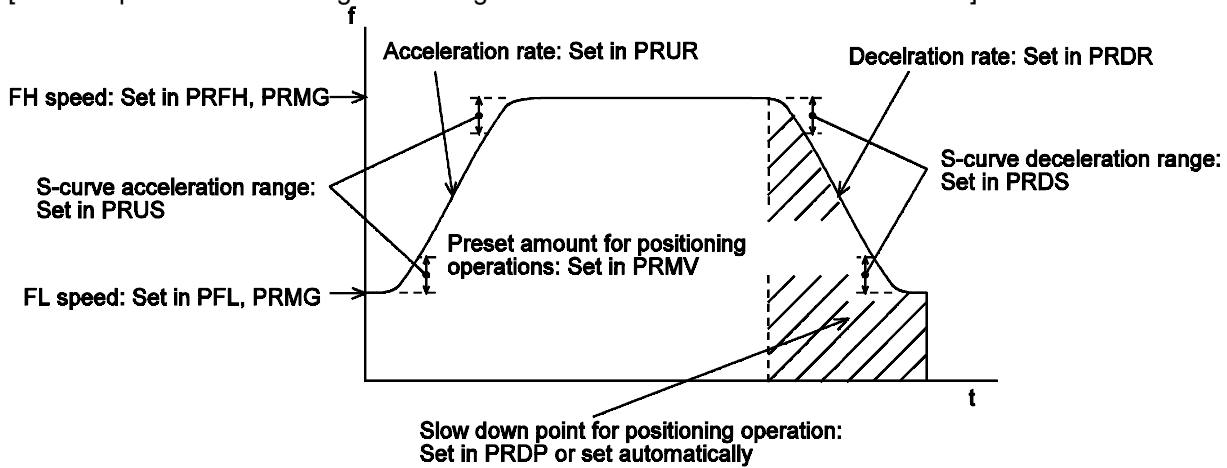

- ◆ PRFL: FL speed setting register (16-bit)
Specify the speed for FL low speed operations and the start speed for high speed operations (acceleration/deceleration operations) in the range of 1 to 65,535 (0FFFFh).
The speed will be calculated from the value in PRMG.
FL speed [pps] = $PRFL \times \frac{\text{Reference clock frequency [Hz]}}{(RMG + 1) \times 65536}$
- ◆ PRFH: FH speed setting register (16-bit)
Specify the speed for FH low speed operations and the start speed for high speed operations (acceleration/deceleration operations) in the range of 1 to 65,535 (0FFFFh).
When used for high speed operations (acceleration/deceleration operations), specify a value larger than PRFL.
The speed will be calculated from the value placed in RMG.
FH speed [pps] = $PRFH \times \frac{\text{Reference clock frequency [Hz]}}{(RMG + 1) \times 65536}$

◆ PRUR: Acceleration rate setting register (16-bit)

Specify the acceleration characteristic for high speed operations (acceleration/deceleration operations), in the range of 1 to 65,535 (0FFFFh)

Relationship between the value entered and the acceleration time will be as follows:

1) Linear acceleration (MSMD = 0 in the PRMD register)

$$\text{Acceleration time [s]} = \frac{(\text{PRFH} - \text{PRFL}) \times (\text{PRUR} + 1) \times 4}{\text{Reference clock frequency [Hz]}}$$

2) S-curve without a linear range (MSMD=1 in the PRMD register and PRUS register =0)

$$\text{Acceleration time [s]} = \frac{(\text{PRFH} - \text{PRFL}) \times (\text{PRUR} + 1) \times 8}{\text{Reference clock frequency [Hz]}}$$

3) S-curve with a linear range (MSMD=1 in the PRMD register and PRUS register >0)

$$\text{Acceleration time [s]} = \frac{(\text{PRFH} - \text{PRFL} + 2 \times \text{PRUS}) \times (\text{PRUR} + 1) \times 4}{\text{Reference clock frequency [Hz]}}$$

◆ PRDR: Deceleration rate setting register (16-bit)

Normally, specify the deceleration characteristics for high speed operations (acceleration/deceleration operations) in the range of 1 to 65,535 (0FFFFh).

Even if the ramping-down point is set to automatic (MSDP = 0 in the PRMD register), the value placed in the RDR register will be used as the deceleration rate.

However, when PRDR = 0, the deceleration rate will be the value placed in the PRUR.

When the ramping-down point is set to automatic, there are the following restrictions.

While in linear interpolation 1 or circular interpolation operation, and when synthesized constant speed operation (MIPF = 1 in PRMD) is selected, make the deceleration time = the acceleration time.

For other operations, arrange (deceleration time) ≤ acceleration time x 2.

If setting otherwise, the axis may not decrease the speed to the specified FL speed when stopping. In this case, use a manual ramping-down point (MSDP = 1 in the RMD register).

< When (deceleration time) ≤ (acceleration time x 2) using an automatic ramping-down point >

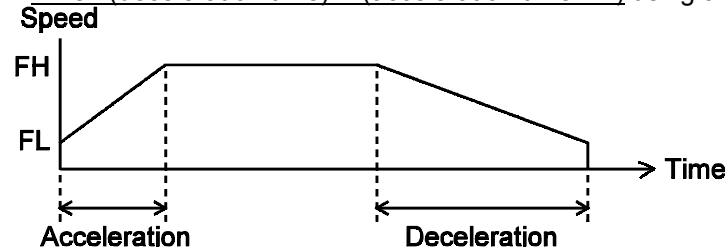

<When (deceleration time) > (acceleration time x 2) using an automatic ramping-down point>

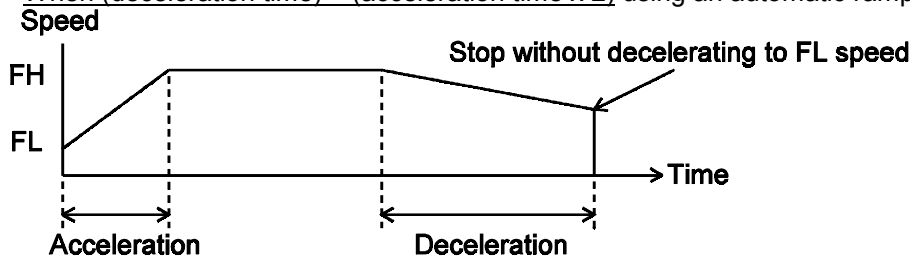

The relationship between the value entered and the deceleration time is as follows.

1) Linear deceleration (MSMD = 0 in the PRMD register)

$$\text{Deceleration time [s]} = \frac{(\text{PRFH} - \text{PRFL}) \times (\text{PRDR} + 1) \times 4}{\text{Reference clock frequency [Hz]}}$$

2) S-curve deceleration without a linear range (MSMD=1 in the PRMD register and PRDS register = 0)

$$\text{Deceleration time [s]} = \frac{(\text{PRFH} - \text{PRFL}) \times (\text{PRDR} + 1) \times 8}{\text{Reference clock frequency [Hz]}}$$

3) S-curve deceleration with a linear range (MSMD=1 in the PRMD register and PRDS register >0)

$$\text{Deceleration time [s]} = \frac{(\text{PRFH} - \text{PRFL} + 2 \times \text{PRDS}) \times (\text{PRDR} + 1) \times 4}{\text{Reference clock frequency [Hz]}}$$

◆ PRMG: Magnification rate register (12-bit)

Specify the relationship between the PRFL and PRFH settings and the speed, in the range of 2 to 4,095 (0FFFh). As the magnification rate is increased, the speed setting units will tend to be approximations. Normally set the magnification rate as low as possible.

The relationship between the value entered and the magnification rate is as follows.

$$\text{Magnification rate} = \frac{\text{Reference clock frequency [Hz]}}{(\text{PRMG} + 1) \times 65536}$$

[Magnification rate setting example, when the reference clock =19.6608 MHz] (Output speed unit: pps)

Setting	Magnification rate	Output speed range	Setting	Magnification rate	Output speed range
2999 (0BB7h)	0.1	0.1 to 6,553.5	59 (3Bh)	5	5 to 327,675
1499 (5DBh)	0.2	0.2 to 13,107.0	29 (1Dh)	10	10 to 655,350
599 (257h)	0.5	0.5 to 32,767.5	14 (0Eh)	20	20 to 1,310,700
299 (12Bh)	1	1 to 65,535	5 (5h)	50	50 to 3,276,750
149 (95h)	2	2 to 131,070	2 (2h)	100	100 to 6,553,500

◆ PRDP: Ramping-down point register (24-bits)

Specify the value used to determine the deceleration start point for positioning operations that include acceleration and deceleration.

The meaning of the value specified in the PRDP changes with the "ramping-down point setting method", (MSDP) in the PRMD register.

<When set to manual (MSDP=1 in the PRMD register)>

Set the number of pulses at which to start deceleration, in the range of 0 to 16,777,215 (0FFFFFFh).

The optimum value for the ramping-down point can be calculated as shown in the equation below.

1) Linear deceleration (MSMD=0 of the PRMD register)

$$\text{Optimum value [Number of pulses]} = \frac{(\text{PRFH}^2 - \text{PRFL}^2) \times (\text{PRDR} + 1)}{(\text{PRMG} + 1) \times 32768}$$

However, the optimum value for a triangle start, without changing the value in the PRFH register while turning OFF the FH correction function (MADJ = 1 in the PRMD register) will be calculated as shown in the equation below.

(When using idling control, modify the value for RMV in the equation below by deducting the number of idling pulses from the value placed in the RMV register. The number of idling pulses will be "1 to 6" when IDL = 2 to 7 in RENV5.)

$$\text{Optimum value [Number of pulses]} = \frac{\text{PRMV} \times (\text{PRDR} + 1)}{\text{PRUR} + \text{PRDR} + 2}$$

2) S-curve deceleration without a linear range (MSMD=1 in the PRMD register and the PRDS register =0)

$$\text{Optimum value [Number of pulses]} = \frac{(\text{PRFH}^2 - \text{PRFL}^2) \times (\text{PRDR} + 1) \times 2}{(\text{PRMG} + 1) \times 32768}$$

- 3) S-curve deceleration with a linear range (MSMD=1 in the PRMD register and the PRDS register >0)
 Optimum value [Number of pulses] =
$$\frac{(PRFH + PRFL) \times (PRFH - PRFL + 2 \times PRDS) \times (PRDR + 1)}{(PRMG + 1) \times 32768}$$

 Start deceleration at the point when the (positioning counter value) \leq (RDP set value).

<When set to automatic (MSDP = 0 in the PRMD register)>

This is an offset value for the automatically set ramping-down point. Set in the range of -8,388,608 (800000h) to 8,388,607 (7FFFFFFh).

When the offset value is a positive number, the axis will start deceleration at an earlier stage and will feed at the FL speed after decelerating. When a negative number is entered, the deceleration start timing will be delayed. If the offset is not required, set to zero.

When the value for the ramping-down point is smaller than the optimum value, the speed when stopping will be faster than the FL speed. On the other hand, if it is larger than the optimum value, the axis will feed at FL low speed after decelerating.

◆ PRUS: S-curve acceleration range register (15-bit)

Specify the S-curve acceleration range for S-curve acceleration/deceleration operations in the range of 1 to 32,767 (7FFFh).

The S-curve acceleration range S_{SU} will be calculated from the value placed in PRMG.

$$S_{SU} [\text{pps}] = \text{PRUS} \times \frac{\text{Reference clock frequency [Hz]}}{(PRMG + 1) \times 65536}$$

In other words, speeds between the FL speed and (FL speed + S_{SU}), and between (FH speed - S_{SU}) and the FH speed, will be S-curve acceleration operations. Intermediate speeds will use linear acceleration.

However, if zero is specified, "(PRFH - PRFL)/2" will be used for internal calculations, and the operation will be an S-curve acceleration without a linear component.

◆ PRDS: S-curve deceleration range setting register (15-bit)

Specify the S-curve deceleration range for S-curve acceleration/deceleration operations in the range of 1 to 32,767 (7FFFh).

The S-curve deceleration range S_{SD} will be calculated from the value placed in PRMG.

$$S_{SD} [\text{pps}] = \text{PRDS} \times \frac{\text{Reference clock frequency [Hz]}}{(PRMG + 1) \times 65536}$$

In other words, speeds between the FL speed and (FL speed + S_{SD}), and between (FH speed - S_{SD}) and the FH speed, will be S-curve deceleration operations. Intermediate speeds will use linear deceleration.

However, if zero is specified, "(PRFH - PRFL)/2" will be used for internal calculations, and the operation will be an S-curve deceleration without a linear component.

10-3. Manual FH correction

When the FH correction function is turned ON (MADJ = 0 in the PRMD register), and when the feed amount is too small for a normal acceleration and deceleration operation, the LSI will automatically lower the FH speed to eliminate triangle driving.

However, if values in the PRUR and PRDR registers are set so that the (deceleration time) > (acceleration time x 2), do not use the FH correction function.

In order to eliminate triangle driving without using the FH correction function (MADJ = 1 in the PRMD register), lower the FH speed before starting the acceleration/deceleration operation.

When using idling control, enter a value for PRMV in the equation below after deducting the number of idling pulses. The number of idling pulses will be 1 to 6 when IDL = 2 to 7 in RENV5.

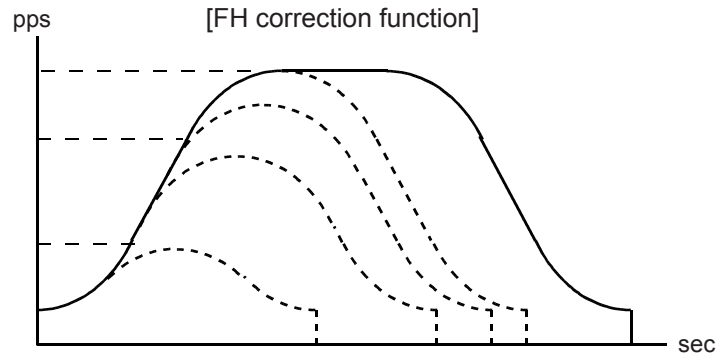

Automatic correction of the maximum speed for changing the feed amount.

< To execute FH correction manually >

1) Linear acceleration/deceleration speed (MSMD=0 in the PRMD register)

$$PRMV \leq \frac{(PRFH^2 - PRFL^2) \times (PRUR + PRDR + 2)}{(PRMG + 1) \times 32768}$$

$$PRFH \leq \sqrt{\frac{(PRMG + 1) \times 32768 \times PRMV}{PRUR + PRDR + 2} + PRFL^2}$$

2) S-curve acceleration without linear acceleration (MSMD=1 in the PRMD and PRDS registers = 0)

$$\text{When } PRMV \leq \frac{(PRFH^2 - PRFL^2) \times (PRUR + PRDR + 2) \times 2}{(PRMG + 1) \times 32768}$$

$$PRFH \leq \sqrt{\frac{(PRMG + 1) \times 32768 \times PRMV}{(PRUR + PRDR + 2) \times 2} + PRFL^2}$$

3) S-curve acceleration/deceleration with linear acceleration/deceleration (MSMD = 1 in the PRMD register and the PRUS register > 0, PRDS register > 0)

(3)-1. When PRUS = PRDS

(i) Set up a small linear acceleration range

$$PRMV \leq \frac{(PRFH + PRFL) \times (PRFH - PRFL + 2 \times PRUS) \times (PRUR + PRDR + 2)}{(PRMG + 1) \times 32768} \quad \text{and}$$

$$PRMV > \frac{(PRUS + PRFL) \times PRUS \times (PRUR + PRDR + 2) \times 8}{(PRMG + 1) \times 32768}$$

$$PRFH \leq -PRSU + \sqrt{(PRUS - PRFL)^2 + \frac{(PRMG + 1) \times 32768 \times PRMV}{(PRUR + PRDR + 2)}}$$

(ii) Eliminate the linear acceleration/deceleration range

$$PRMV \leq \frac{(PRUS + PRFL) \times PRUS \times (PRUR + PRDR + 2) \times 8}{(PRMG + 1) \times 32768}$$

Change to S-curve acceleration/deceleration without a linear acceleration/deceleration range (PRUS = 0, PRDS = 0),

$$PRFH \leq \sqrt{\frac{(PRMG + 1) \times 32768 \times PRMV}{(PRUR + PRDR + 2) \times 2} + PRFL^2}$$

PRMV: Positioning amount	PRFL: Initial speed	PRFH: Operation speed
PRUR: Operation speed acceleration rate	PRDR: Deceleration rate	PRMG: Speed magnification rate
PRUS: S-curve acceleration range	PRDS: S-curve deceleration range	

(3)-2. When PRUS < PRDS

(i) Set up a small linear acceleration/deceleration range

When

$$PRMV \leq \frac{(PRFH+PRFL) \times \{(PRFH-PRFL) \times (PRUR + PRDR + 2) + 2 \times PRUS \times (PRUR+1) + 2 \times PRDS \times (PRDR + 1)\}}{(PRMG + 1) \times 32768}$$

and

$$PRMV > \frac{(PRDS+PRFL) \times \{PRDS \times (PRUR + 2 \times PRDR + 3) + PRUS \times (PRUR + 1)\} \times 4}{(PRMG + 1) \times 32768},$$

$$PRFH \leq \frac{-A + \sqrt{A^2 + B}}{PRUR + PRDR + 2}$$

However, A = PRUS x (PRUR + 1) + PRDS x (PRDR + 1)

B= {(PRMG + 1) x 32768 x PRMV - 2 x A x PRFL + (PRUR + PRDR + 2) x PRFL²} x (PRUR + PRDR + 2)

(ii) Eliminate the linear acceleration/deceleration range and set up a small linear acceleration section.

When

$$PRMV \leq \frac{(PRDS + PRFL) \times \{PRDS \times (PRUR + 2 \times PRDR + 3)\} + PRUS \times (PRUR + 1)}{(PRMG + 1) \times 32768} \quad \text{and}$$

$$PRMV > \frac{(PRUS + PRFL) \times PRUS \times (PRUR + PRDR + 2) \times 8}{(PRMG + 1) \times 32768},$$

Change to S-curve acceleration/deceleration without any linear acceleration/deceleration (PRUS>0, PRDS=0)

$$PRFH \leq \frac{-A + \sqrt{A^2 + B}}{PRUR + 2 \times PRDR + 3}$$

However, A = PRUS x (PRUR + 1),

B= {(PRMG + 1) x 32768 x PRMV - 2 x A x PRFL + (PRUR + 2 x PRDR + 3) x PRFL²} x (PRUR + 2 x PRDR + 3)

(iii) Eliminate the linear acceleration/deceleration range

$$\text{When } PRMV \leq \frac{(PRUS + PRFL) \times PRUS \times (PRUR + PRDR + 2) \times 8}{(PRMG + 1) \times 32768}$$

Change to S-curve acceleration/deceleration without any linear acceleration/deceleration (PRUS=0, PRDS=0),

$$PRFH \leq \sqrt{\frac{(PRMG + 1) \times 32768 \times PRMV}{(PRUR + PRDR + 2) \times 2} + PRFL^2}$$

PRMV: Positioning amount

PRUR: Operation speed acceleration rate

PRUS: S-curve acceleration range

PRFL: Initial speed

PRDR: Deceleration rate

PRDS: S-curve deceleration range

PRFH: Operation speed

PRMG: Speed magnification rate

(3)-3. When PRUS>PRDS

(i) Set up a small linear acceleration/deceleration range

When

$$PRMV \leq \frac{(PRFH + PRFL) \times \{(PRFH - PRFL) \times (PRUR + PRDR + 2) + 2 \times PRUS \times (PRUR + 1) + 2 \times PRDS \times (PRDR + 1)\}}{(PRMG + 1) \times 32768}$$

and

$$PRMV > \frac{(PRUS + PRFL) \times \{PRUS \times (2 \times PRUR + PRDR + 3) + PRDS \times (PRDR + 1) \times 4\}}{(PRMG + 1) \times 32768},$$

$$PRFH \leq \frac{-A + \sqrt{A^2 + B}}{PRUR + PRDR + 2}$$

However, A = PRUS x (PRUR + 1) + PRDS x (PRDR + 1),

B = {(PRMG + 1) x 32768 x PRMV - 2 x A x PRFL + (PRUR + PRDR + 2) x PRFL²} x (PRUR + PRDR + 2)

(ii) Eliminate the linear acceleration section and set up a small linear deceleration range.

When

$$PRMV \leq \frac{(PRUS + PRFL) \times \{PRUS \times (2 \times PRUR + PRDR + 3) + PRDS \times (PRDR + 1)\} \times 4}{(PRMG + 1) \times 32768} \text{ and}$$

$$PRMV > \frac{(PRDS + PRFL) \times PRDS \times (PRUR + PRDR + 2) \times 8}{(PRMG + 1) \times 32768},$$

Change to S-curve acceleration/deceleration without any linear acceleration (PRUS = 0, PRDS > 0)

$$PRFH \leq \frac{-A + \sqrt{A^2 + B}}{2 \times PRUR + PRDR + 3}$$

However, A = PRDS x (PRDR + 1),

B = {(PRMG + 1) x 32768 x PRMV - 2 x A x PRFL + (2 x PRUR + PRDR + 3) x PRFL²} x (2 x PRUR + PRDR + 3)

(iii) Eliminate the linear acceleration/deceleration range

$$\text{When } PRMV \leq \frac{(PRDS + PRFL) \times PRDS \times (PRUR + PRDR + 2) \times 8}{(PRMG + 1) \times 32768}$$

Change to S-curve acceleration/deceleration without any linear acceleration/deceleration (PRUS = 0, PRDS = 0),

$$PRFH \leq \sqrt{\frac{(PRMG + 1) \times 32768 \times PRMV}{(PRUR + PRDR + 2) \times 2} + PRFL^2}$$

PRMV: Positioning amount	PRFL: Initial speed	PRFH: Operation speed
PRUR: Operation speed acceleration rate	PRDR: Deceleration rate	PRMG: Speed magnification rate
PRUS: S-curve acceleration range	PRDS: S-curve deceleration range	

10-4. Example of setting up an acceleration/deceleration speed pattern

Ex. Reference clock = 19.6608 MHz

When the start speed = 10 pps, the operation speed = 100 kpps, and the accel/decel time = 300 msec,

- 1) Select the 2x mode for multiplier rate in order to get 100 kpps output
PRMG = 149 (95h)
- 2) Since the 2x mode is selected to get an operation speed 100 kpps,
PRFH = 50000 (C350h)
- 3) In order to set a start speed of 10 pps, the rate magnification is set to the 2x mode.
PRFL = 5 (0005h)
- 4) In order to make the acceleration/deceleration time 300 msec, set PRUR = 28,494, from the equation for the acceleration time and the RUR value.

$$\text{Acceleration time [s]} = \frac{(\text{PRFH} - \text{PRFL}) \times (\text{PRUR} + 1) \times 4}{\text{Reference clock frequency [Hz]}}$$

$$0.3 = \frac{(50000 - 5) \times (\text{PRUR} + 1) \times 4}{19.6608 \times 10^6}$$

$$\text{PRUR} = 28.494$$

However, since only integers can be entered for PRUR, use 28 or 29. The actual acceleration/deceleration time will be 295 msec if PRUR = 28, or 305 msec if PRUR = 29.

An example of the speed pattern when PRUR = 29

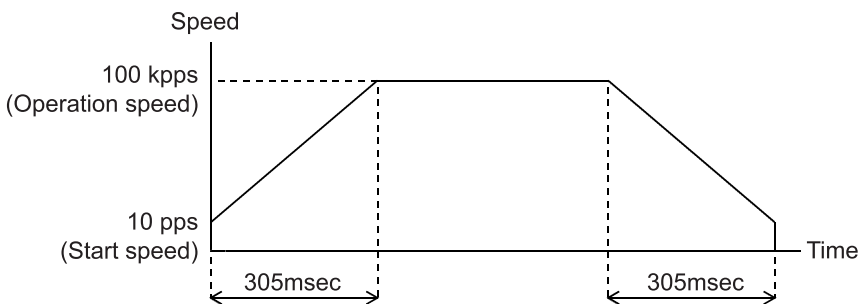

10-5. Changing speed patterns while in operation

By changing the RFH, RUR, RDR, RUS, or RDS registers during operation, the speed and acceleration can be changed on the fly. However, if the ramping-down point was set to automatic (MSDP = 0 in the RDM register) for the positioning mode, do not change the values for RFL, RUR, RDR, RUS, or RDS. The automatic ramping-down point function will not work correctly.

An example of changing the speed pattern by changing the speed, during a linear acceleration/deceleration operation

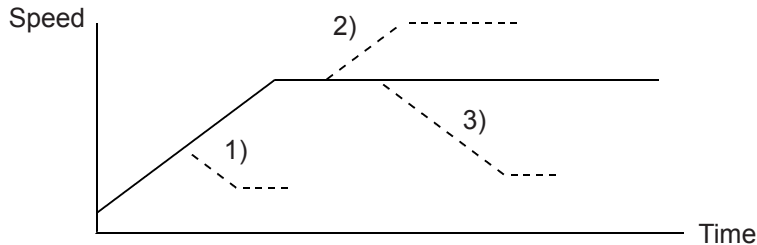

- 1) Use a small RFH while accelerating or decelerating the axis until it reaches the correct speed.
- 2), 3) Change RFH after the acceleration/deceleration is complete. The axis will continue accelerating or decelerating until it reaches the new speed.

An example of changing the speed pattern by changing the speed during S-curve acceleration/deceleration operation

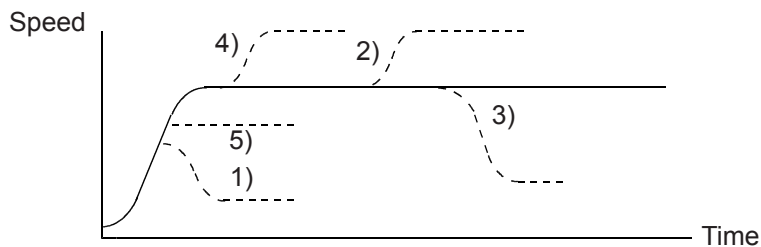

- 1) Use a small RFH and if $((\text{change speed}) < (\text{speed before change}))$ and the axis will accelerate/decelerate using an S-curve until it reaches the correct speed.
- 5) Use a small RFH and if $((\text{change speed}) \geq (\text{speed before change}))$ and the axis will accelerate/decelerate without changing the S-curve's characteristic until it reaches the correct speed.
- 4) Use a large RFH while accelerating and the axis will accelerate to the original speed entered without changing the S-curve's characteristic. Then it will accelerate again until it reaches the newly set speed.
- 2), 3) If RFH is changed after the acceleration/deceleration is complete, the axis will accelerate/decelerate using an S-curve until it reaches the correct speed.

11. Description of the Functions

11-1. Reset

After turning ON the power, make sure to reset the LSI before beginning to use it.
To reset the LSI, hold the $\overline{\text{RST}}$ terminal LOW while supplying at least 8 cycles of a reference clock signal.
After a reset, the various portions of the LSI will be configured as follows.

Item	Reset status (initial status) n = x, y, z, u
Internal registers, pre-register	0
Control command buffer	0
Axis assignment buffer	0
Input/output buffer	0
INT terminal	HIGH
$\overline{\text{WRQ}}$ terminal	HIGH
$\overline{\text{IFB}}$ terminal	HIGH
D0 to D7 terminals	High Z (impedance)
D8 to D15 terminals	High Z (impedance)
P0n to P7n terminals	Input terminal
$\overline{\text{CSTA}}$ terminal	HIGH
$\overline{\text{CSTP}}$ terminal	HIGH
OUTn terminal	HIGH
DIRn terminal	HIGH
ERCn terminal	HIGH
$\overline{\text{BSYn}}$ terminal	HIGH

11-2. Position override

This LSI can override (change) the target position freely during operation. There are two methods for overriding the target position.

11-2-1. Target position override 1

By rewriting the target position data (RMV register value), the target position can be changed. The starting position is used as a reference to change target position.

1) If the new target position is further away from the original target position during acceleration or low speed operation, the axis will maintain the operation using the same speed pattern and it will complete the positioning operation at the position specified in the new data (new RMV value).

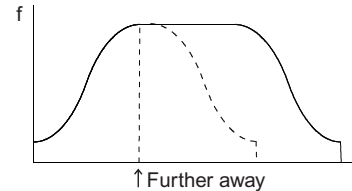

2) If the new target position is further away from the original target position during deceleration, the axis will accelerate from the current position to FH speed and complete the positioning operation at the position specified in the new data (new RMV value).

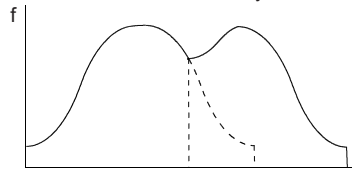

Assume that the current speed is F_u , and when $RFL = F_u$, a curve of next acceleration will be equal to a normal acceleration curve.

3) If the axis has already passed over the new target position, or the target position is changed to a position that is closer than the original position during deceleration, movement on the axis will decelerate and stop. Then, the movement will reverse and complete the positioning operation at the position specified in the new data (new RMV value).

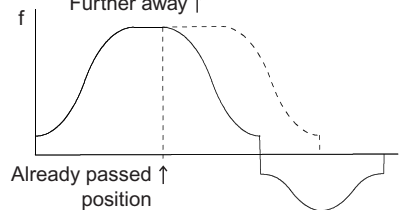

The axis accelerates/decelerates only when starting in high speed. The target position data (RMV register value) can be rewritten any number of times until the positioning operation is complete.

Note1: If the ramping-down point is set to automatic and the (deceleration time) > (acceleration time x 2), it may be the case that the axis cannot reduce the speed to the FL level, as shown below. In this case, if the target position is set closer than original position and the axis is decelerating, the axis will decelerate along the deceleration curve to the new override position, and then slow to the FL speed and finally stop.

Therefore, the axis will overrun the original target position during deceleration (shaded area).

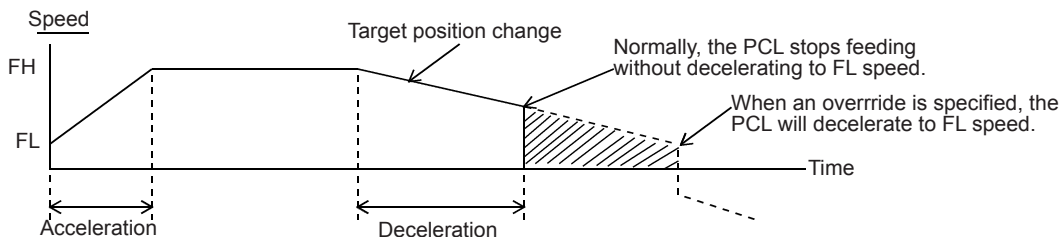

To avoid creating an overrun condition, make sure that the deceleration time is less than two times the acceleration time, or if the deceleration time is more than double the acceleration time, make the ramping-down point a manual setting.

Note 2: The position override is only valid while feeding.

When the PCL receives an override command just a little before stopping a feed, it may not respond to the override command. For this reason, check SEOR in the main status after sending an override command. If the override is ignored, the SEOR will become "1."

The PCL will set SEOR to "1" when it receives a command in the RMV register (90h) while feeding is stopped, to allow the override command to be evaluated. Therefore, if the command is written to the RMV register while stopped, before feeding starts, the SEOR will also become "1."

When the override command is ignored, after writing the RMV write command (90h), the PCL will set SEOR to "1" within five CLK cycles. After reading the MSTs, the PCL will set SEOR to "0" within three CLK cycles.

Note 3: A Position Override 1 cannot be executed while performing an interpolation operation.

11-2-2. Target position override 2 (PCS signal)

By making MPCS in the PRMD (operation mode) register "1," the PCL will perform positioning operations for the amount specified in the PRMV register, based on the timing of this command after the operation start (after it starts outputting instruction pulses) or on the "ON" timing of the PCS input signal. A PCS input signal can change the input logic. The PCS terminal status can be monitored using the RSTS register (extension status).

Setting pulse control using the PCS input <Set MPCS (bit 14) in PRMD> 1: Positioning for the number of pulses stored in the PRMV, starting from the time at which the PCS input signal is turned ON.	[PRMD] (WRITE) 15 8 - n - - - - - -
Setting the PCS input logic <Set PCSL (bit 24) in RENV1> 0: Negative logic 1: Positive logic	[RENV1] (WRITE) 31 24 - - - - - - - n
Reading the PCS signal <SPCS (bit 8) in MRSTS> 0: Turn OFF PCS 1: Turn ON PCS	[RSTS] (READ) 15 8 - - - - - - - n
PCS substitution input <STAON: Operation command> Perform processes that are identical to those performed by supplying a PCS signal.	[Operation command] 28h

Note: A Position Override 2 cannot be executed while performing an interpolation operation.

11-3. Output pulse control

11-3-1. Output pulse mode

There are four types of common command pulse output modes and two types of 2-pulse modes.

Common pulse mode: Outputs operation pulses from the OUT terminal and outputs the direction signal from the DIR terminal.

2-pulse mode: Outputs positive direction operation pulses from the OUT terminal, and outputs negative direction operation pulses from the DIR terminal.

The output mode for command pulses is set in PMD (bits 0 to 2) in RENV1 (environment setting 1).

If motor drivers using the common pulse mode need a lag time (since the direction signal changes, until receiving a command pulse), use a direction change timer.

When DTMP (bit 28) in the RENV1 (environment setting 1) is set to 0, the operation can be delayed for one direction change timer unit (0.2 msec), after changing the direction identification signal.

Setting the pulse output mode <Set PMD0 to 2 (bits 0 to 2) in RENV1>					[RENV1] (WRITE)
PMD0 to 2	When feeding in the positive direction		When feeding in the negative direction		7 - - - - - n n n 0
	OUT output	DIR output	OUT output	DIR output	
000		High		Low	
001		High		Low	
010		Low		High	
011		Low		High	
100		High	High		
111		Low	Low		

Setting the direction change timer (0.2 msec) function <Set DTMP (bit 28) in RENV1>		[RENV1] (WRITE)
0: ON	1: OFF	31 - - - n - - - - 24

11-3-2. Control the output pulse width and operation complete timing

In order to increase the stopping speed, this LSI controls the output pulse width.

When the output pulse speed is slower than 1/8192 of reference clock (approx. 2.4 Kpps when CLK = 19.6608 MHz), the pulse width is constant and is 4096 cycles of the reference clock (approx. 200 μsec when CLK = 19.6608 MHz). For faster pulse speeds than this, the duty cycle is kept constant (approx. 50%). By setting PDTC (bit 13) in the RENV1 register (environment setting 1), the output pulse width can be set to make a constant duty cycle (50%).

Also, when setting METM (operation completion timing setting) in the PRMD register (operation mode), the operation complete timing can be changed.

1) When METM = 0 (the point at which the output frequency cycle is complete) in the PRMD register

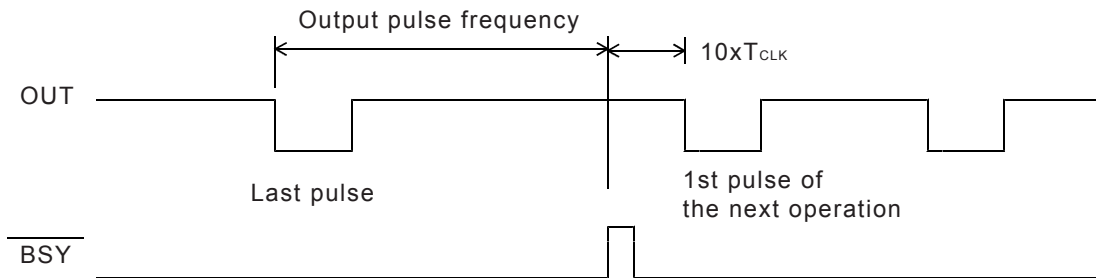

2) When METM = 1 (when the output pulse is OFF) in the PRMD register

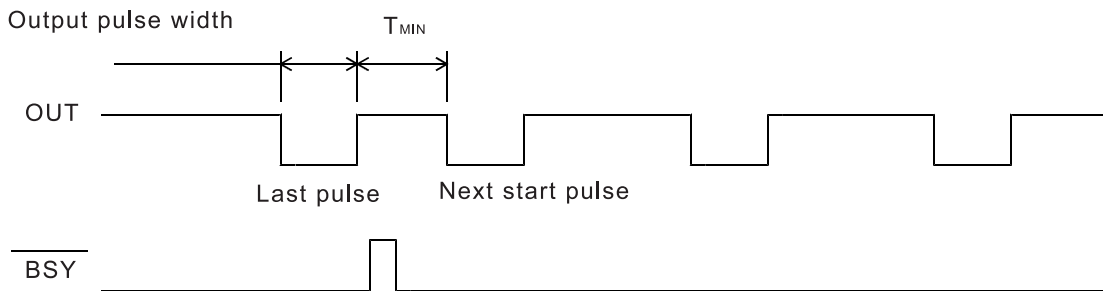

When set to "complete when the output pulse is OFF," the time interval "Min" from the last pulse until the next starting pulse output will be $T_{MIN} = 15 \times T_{CLK}$. (T_{CLK} : Reference clock frequency)

Setting the operation complete timing <Set METM (bit 12) in PRMD> 0: At the end of a cycle of a particular output frequency 1: Complete when the output pulse turns OFF.	[RMD] (WRITE) 15 8 - - - n - - - -
Setting the output pulse width <Set PDTC (bit 31) in RENV1> 0: Automatically change between a constant output pulse and a constant duty cycle (approx. 50%) in accord with variations in speed. 1: Keep the output pulse width at a constant duty cycle (approx. 50%).	[RENV1] (WRITE) 31 24 n - - - - - -

11-4. Idling control

When starting an acceleration or a deceleration operation, it can be started after the output of a few pulses at FL speed (idling output). Set the number of pulses for idling in IDL of the RENV5 register (environment setting 5).

If you will not be using this function, enter a value "n" of 0 or 1. The LSI will start the acceleration at the same time it begins outputting pulses. Therefore, the start speed obtained from an initial 2-pulse frequency will be faster than the FL speed.

To use this function, enter a value "n" of 2 to 7. The LSI will start the acceleration by beginning its output on the "n" th pulse. Therefore, the start speed will be the FL speed and the FL speed can be set to start automatically at upper speed limit.

If this function is used with the positioning mode, the total feed amount will not change.

[Setting idling pulses and the acceleration start timing]

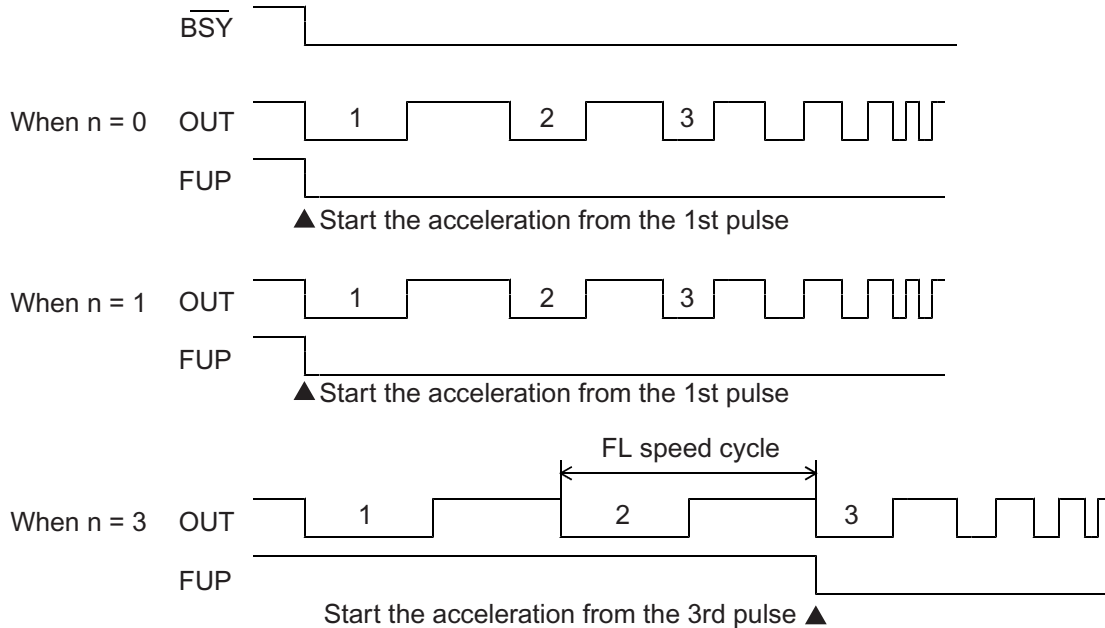

Set the number of idling pulses <Set IDL0 to 2 (bits 8 to 10) in RENV5> Specify the number of idling pulses, from 0 to 7. Start accelerating at FL speed after outputting the specified number of pulses.	[RENV5] (WRITE) 15 8 - - - - n n n
Read the idling control counter value < IDC0 to 2 (bits 20 to 22) in RSPD> Read the idling control counter.	[RSPD] (READ) 23 16 0 n n n - - - -

Note: While setting the number of idling pulses, when you write a High-Speed Start 1 command (52h or 56h), the PCL will accelerate to FH speed after outputting the specified number of idling pulses at FL speed. Then the operation will be the same as the High-Speed Start 2 command.

11-5. Mechanical external input control

11-5-1. +EL, -EL signal

When an end limit signal (a +EL signal when feeding in the + direction) in the feed direction turns ON while operating, the axis will stop immediately or decelerate and stop. After stopping, even if the EL signal is turned OFF, the axis will remain stopped. For safety, keep the EL signal ON until the axis reaches the end of the stroke.

If the EL signal is ON when writing a start command, the axis cannot start moving in the direction of the particular EL signal that is ON.

By setting ELM in the RENV1 (environment setting 1) register, the stopping pattern for use when the EL signal is turned ON can be set to immediate stop or deceleration stop (high speed start only).

The minimum pulse width of the EL signal is 80 reference clock cycles (4 μsec) when the input filter is ON. When the input filter is turned OFF, the minimum pulse width is two reference clock cycles (0.1 μsec).

The EL signal can be monitored by reading SSTS_W (sub status).

By reading the REST register, you can check for an error interrupt caused by the EL signal turning ON. When in the timer mode, this signal is ignored. Even in this case, the EL signal can be monitored by reading SSTS_W (sub status).

The input logic of the EL signal can be set for each axis using the ELL input terminal.

Set the input logic of the ±EL signal <ELL input terminal> L: Positive logic input H: Negative logic input	
Stop method to when the ±EL signal turns ON <Set ELM (bit 3) in RENV1> 0: Immediate stop by turning ON the ±EL signal 1: Deceleration stop by turning ON the ±EL signal	[RENV1] (WRITE) 7 0 - - - n - - -
Reading the ±EL signal <SPEL (bit 12), SMEL (bit 13) in SSTS _W > SPEL = 0: Turn OFF the +EL signal SPEL = 1: Turn ON the +EL signal SMEL = 0: Turn OFF the -EL signal SMEL = 1: Turn ON the -EL signal	[SSTS _W] (READ) 15 8 - - n n - - - -
Reading the stop cause when the ±EL signal turns on <ESPL (bit 5), ESML (bit 6) in REST> ESPL = 1: Stop by turning ON the +EL signal ESML = 1: Stop by turning ON the -EL signal	[REST] (READ) 7 0 - n n - - - - -
Setting the ±EL input filter <Set FLTR (bit 26) in RENV1> 1: Apply a filter to the ±EL input Apply a filter and any signals shorter than 4 μsec pulse width are ignored.	[RENV1] (WRITE) 27 20 - - - - - n - - -

Note 1: Operation after turning ON the EL signal may be different for the zero return operation (9-5-1), the zero search operation (9-5-3), and the EL or SL operation mode (9-6). See the description of each operation mode.

11-5-2. SD signal

If the SD signal input is disabled by setting MSDE in the PRMD register (operation mode), the SD signal will be ignored.

If the SD signal is enabled and the SD signal is turned ON while in operation, the axis will: 1) decelerate, 2) latch and decelerate, 3) decelerate and stop, or 4) latch and perform a deceleration stop, according to the setting of SDM and SDLT in the RENV1 register (environment setting 1).

1) Deceleration < SDM (bit 4) = 0, SDLT (bit 5) = 0 in RENV1 register>

- While feeding at low speed, the SD signal is ignored. While in high speed operation the axis decelerates to the FL speed when the SD signal is turned ON. After decelerating, or while decelerating, if the SD signal turns OFF, the axis will accelerate to the FH speed.
- If the SD signal is turned ON when the high speed command is written, the axis will operate at FL speed. When the SD signal is turned OFF, the axis will accelerate to FH speed.

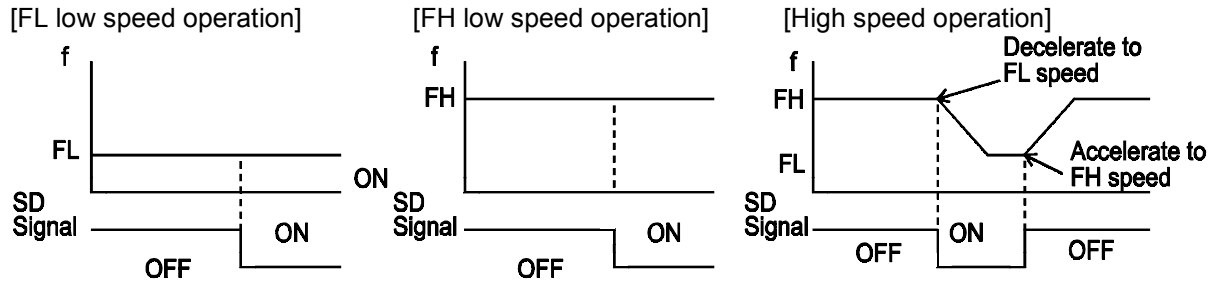

2) Latch and decelerate <SDM (bit 4) = 0, SDLT (bit 5) = 1 in RENV1 register>

- While feeding at low speed, the SD signal is ignored. While in high speed operation, decelerate to FL speed by turning the SD signal ON. Even if the SD signal is turned OFF after decelerating or while decelerating, the axis will continue moving at FL speed and will not accelerate to FH speed.
- If the SD signal is turned ON while writing a high speed command, the axis will feed at FL speed. Even if the SD signal is turned OFF, the axis will not accelerate to FH speed.

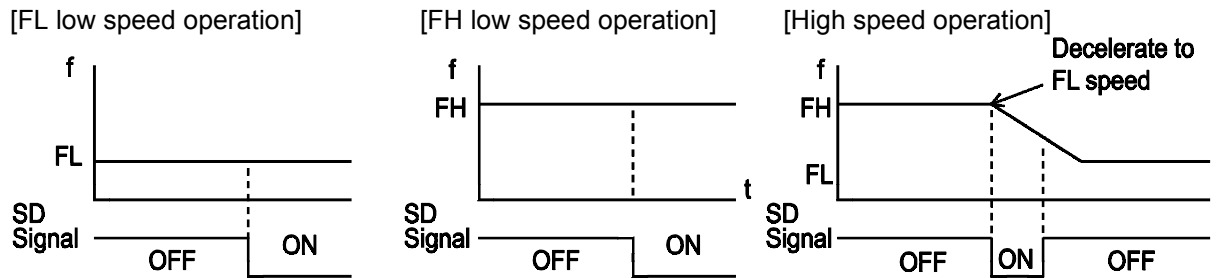

3) Deceleration stop <SDM (bit 4) = 1, SDLT (bit 5) = 0 in RENV1 register>

- If the SD signal is turned ON while in low speed operation, the axis will stop. While in high speed operation, the axis will decelerate to FL speed when the SD signal is turned ON, and then stop. If the SD signal is turned OFF during deceleration, the axis will accelerate to FH speed.
- If the SD signal is turned ON after writing a start command, the axis will complete its operation without another start.
- When stopped, the axis will output an \overline{INT} signal.

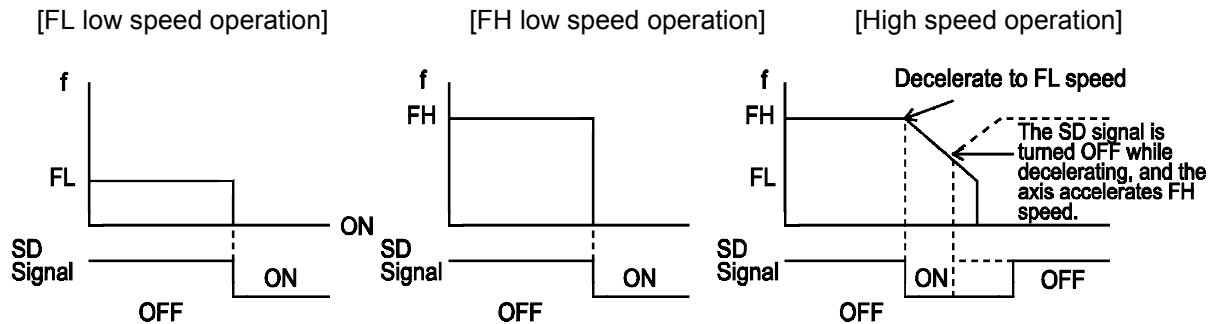

4) Latched, deceleration stop <SDM (bit 4) = 1, SDLT (bit 5)=1 in RENV1>

- If the SD signal is turned ON while in low speed operation, the axis will stop. If the SD signal is turned ON while in high speed operation, the axis will decelerate to FL speed and then stop. Even if the SD signal is turned OFF during deceleration, the axis will not accelerate.
- If the SD signal is turned ON while writing a start command, the axis will not start moving and the operation will not be completed.
- While stopped, the LSI outputs an $\overline{\text{INT}}$ signal.

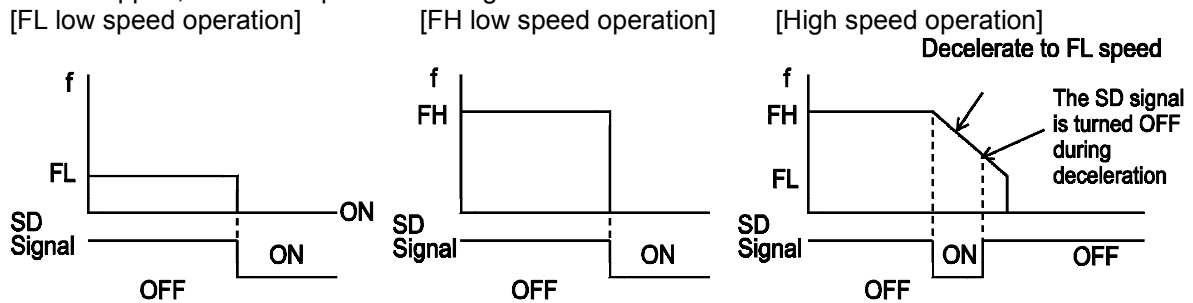

The input logic of the SD signal can be changed. If the latched input is set to accept input from the SD signal, and if the SD signal is OFF at the next start, the latch will be reset. The latch is also reset when the latch input is set to zero.

The minimum pulse width of the SD signal is 80 reference clock cycles (4.0 μsec) when the input filter is ON. When the input filter is turned OFF, the minimum pulse width is two reference clock cycles (0.1 μsec). (When CLK = 19.6608 MHz.)

The latch signal of the SD signal can be monitored by reading SSTSW (sub status). The SD signal terminal status can be monitored by reading RSTS (extension status). By reading the REST register, you can check for an error interrupt caused by the SD signal turning ON.

Enable/disable SD signal input <Set MSDE (bit 8) in PRMD> 0: Enable SD signal input 1: Disable SD signal input	[RMD] (WRITE) 15 8 - - - - - n - -
Input logic of the SD signal <Set SDL(bit 6) in RENV1> 0: Negative logic 1: Positive logic	[RENV1] (WRITE) 7 0 - n - - - - - - - -
Set the operation pattern when the SD signal is turned ON <Set SDM (bit 4) in RENV1> 0: Decelerates on receiving the SD signal and feeds at FL low speed 1: Decelerates and stops on receiving the SD signal	[RENV1] (WRITE) 7 0 - - - n - - - - -
Select the SD signal input type <Set SDLT (bit 5) in RENV1> 0: Level input 1: Latch input To release the latch, turn OFF the SD input when next start command is written or select Level input.	[RENV1] (WRITE) 7 0 - - n - - - - - - -
Reading the latch status of the SD signal <SSD (bit 15) in SSTSW> 0: The SD latch signal is OFF 1: The SD latch signal is ON	[SSTSW] (READ) 15 8 n - - - - - - - -
Reading the SD signal <SDIN (bit 15) in the RSTS register> 0: The SD signal is OFF 1: The SD signal is ON	[RSTS] (READ) 15 8 n - - - - - - - -
Reading the cause of an $\overline{\text{INT}}$ when stopped by the SD signal <ESSD (bit 10) in RESET> 1: Deceleration stop caused by the SD signal turning ON	[REST] (READ) 15 8 - - - - 0 n - - - -
Apply an input filter to SD <Set FLTR (bit 26) in RENV1> 1: Apply a filter to the SD input By applying a filter, signals with a pulse width of 4 μsec or less will be ignored.	[RENV1] (WRITE) 31 24 - - - - - n - - - -

11-5-3. ORG, EZ signals

These signals are enabled in the zero return modes (zero return, leave zero position, and zero position search) and in the EZ count operation modes. Specify the operation mode and the operation direction using the PRMD register (operation mode).

Since the ORG signal input is latched internally, there is no need to keep the external signal ON.

The ORG latch signal is reset when stopped.

The minimum pulse width of the ORG signal is 80 reference clock cycles (4 μ sec) when the input filter is ON. When the input filter is turned OFF, the minimum pulse width is two reference clock cycle (0.1 μ sec). (When CLK = 19.6608 MHz.)

The input logic of the ORG signal and EZ signal can be changed using the RENV1 register (environment setting 1).

The ORG terminal status can be monitored by reading SSTS (sub status). The EZ terminal status can be monitored by reading the RSTS register (extension status).

For details about the zero return operation modes, see 9-5, "Zero position operation mode."

ORG signal and EZ signal timing

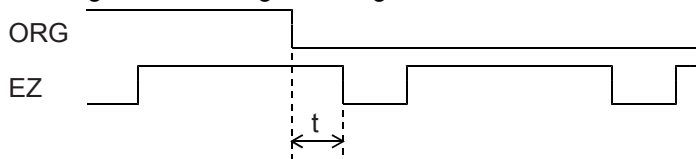

- (i) When $t \geq 2 \times T_{CLK}$, counts.
 - (ii) When $T_{CLK} < t < 2 \times T_{CLK}$, counting is undetermined.
 - (iii) When $t \leq T_{CLK}$, do not count.
- T_{CLK} : Reference clock frequency

Enabling the ORG and EZ signals <Set MOD (bits 0 to 6) in RMD> 001 0000: Zero return in the positive direction 001 0010: Leave zero position in the positive direction 001 0101: Zero position search in the positive direction 010 0100: EZ counting in the positive direction 001 1000: Zero return in the negative direction 001 1010: Leave zero position in the negative direction 001 1101: Zero position search in the negative direction 010 1100: EZ count operation in the negative direction	[RMD] (WRITE) 7 0 [0 n n n n n n n]
Set the zero return method <Set ORM0 to 3 (bits 0 to 3) in RENV3> See the RENV3 register description	[RENV3] (WRITE) 7 0 [- - - - n n n n]
Set the input logic for the ORG signal <Set ORGL (bit 7) in RENV1> 0: Negative logic 1: Positive logic	[RENV1] (WRITE) 7 0 [n - - - - - - -]
Read the ORG signal <SORG (bit 14) in SSTS> 0: The ORG signal is OFF 1: The ORG signal is ON	[SSTS] (READ) 15 8 [- n - - - - - -]
Set the EZ count number <Set EZD0 to 3 (bits 4 to 7) in RENV3> Set the zero return completion condition and the EZ count number for counting. Specify the value (the number to count to ñ 1) in EZD0 to 3. The setting range is 0 to 15.	[RENV3] (WRITE) 7 0 [n n n n - - - -]
Specify the input logic of the EZ signal <Set EZL (bit 23) in RENV2> 0: Falling edge 1: Rising edge	[RENV2] (WRITE) 23 16 [n - - - - - - -]
Read the EZ signal <SEZ (bit 10) in RSTS> 0: The EZ signal is OFF 1: The EZ signal is ON	[RSTS] (READ) 15 8 [- - - - - n - -]
Apply an input filter to ORG <Set FLTR (bit 26) in RENV1> 1: Apply a filter to the ORG input By applying a filter, signals with a pulse width of 4 μ sec or less will be ignored.	[RENV1] (WRITE) 31 24 [- - - - - n - -]

11-6. Servomotor I/F (Case in digital servo)

11-6-1. INP signal

The pulse strings input accepting servo driver systems have a deflection counter to count the difference between command pulse inputs and feedback pulse inputs. The driver controls to adjust the difference to zero. In other words, the effective function of servomotors is to delete command pulses and, even after the command pulses stop, the servomotor systems keep feeding until the count in the deflection counter reaches zero.

This LSI can receive a positioning complete signal (INP signal) from a servo driver in place of the pulse output complete timing, to determine when an operation is complete.

When the INP signal input is used to indicate the completion status of an operation, the $\overline{\text{BSY}}$ signal when an operation is complete, the main status (bits 0 to 5 of the MSECTSW, stop condition), and the extension status (CND0 to 3, operation status) will also change when the INP signal is input.

The input logic of the INP signal can be changed.

The minimum pulse width of the INP signal is 80 reference clock cycles (4 μsec) when the input filter is ON. If the input filter is OFF, the minimum pulse width will be 2 reference clock cycles (0.1 μsec). (When CLK = 19.6608 MHz)

If the INP signal is already ON when the PCL is finished outputting pulses, it treats the operation as complete, without any delay.

The INP signal can be monitored by reading the RSTS register (extension status).

Set the operation complete delay using the INP signal <Set MINP (bit 9) in PRMD> 0: No operation complete delay waiting for the INP signal. 1: Operation complete (status, $\overline{\text{BSY}}$) delay until the INP signal turns ON.	[RMD] (WRITE) 15 8 - - - - - n -
Input logic of the INP signal <Set INPL (bit 22) in RENV1> 0: Negative logic 1: Positive logic	[RENV1] (WRITE) 23 16 - n - - - - -
Reading the INP signal <SINP (bit 16) in RSTS> 0: The INP signal is OFF 1: The INP signal is ON	[RSTS] (READ) 23 16 0 0 0 0 0 0 0 n
Set the INP input filter <FLTR (bit 26) in RENV1> 1: Apply a filter to the INP input. By applying a filter, pulses less than 4 μsec in width are ignored.	[RENV1] (WRITE) 31 24 - - - - - n - -

11-6-2. ERC signal

A servomotor delays the stop until the deflection counter in the driver reaches zero, even after command pulses have stopped being delivered. In order to stop the servomotor immediately, the deflection counter in the servo driver must be cleared.

This LSI can output a signal to clear the deflection counter in the servo driver. This signal is referred to as an "ERC signal." The ERC signal is output as one shot signal or a logic level signal. The output type can be selected by setting the RENV1 register (environment setting 1). If an interval is required for the servo driver to recover after turning OFF the ERC signal (HIGH) before it can receive new command pulses, the ERC signal OFF timer can be selected by setting the RENV1 register.

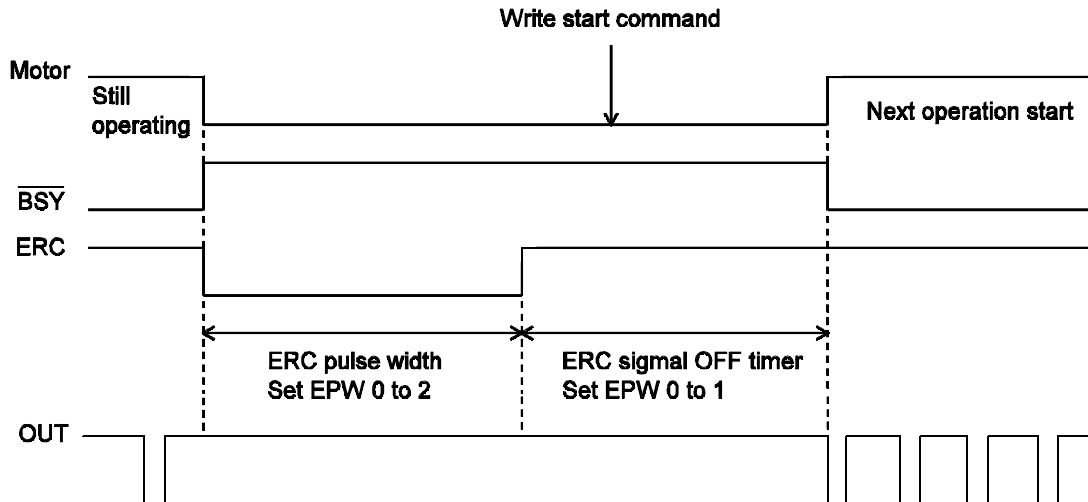

In order to output an ERC signal at the completion of a zero return operation, set EROR (bit 11) = 1 in the RENV1 register (environment setting 1) to make the ERC signal an automatic output. For details about ERC signal output timing, see the timing waveform in section 9-5-1, "Zero return operation."

In order to output an ERC signal for an immediate stop based on the EL signal, ALM signal, or $\overline{\text{CEMG}}$ signal input, or on the emergency stop command (05h), set EROE (bit 10) = 1 in the RENV1 register, and set automatic output for the ERC signal. (In the case of a deceleration stop, the ERC signal cannot be output, even when set for automatic output.)

The ERC signal can be output by writing an ERC output command (24h).

The output logic of the ERC signal can be changed by setting the RENV1 register. Read the RSTS (extension status) register to monitor the ERC signal.

Emergency stop command <CMEMG: Operation command> Output an ERC signal	[Operationcommand] 05h
ERC signal output command <ERCOUT: Control command> Turn ON the ERC signal	[Control command] 24h
ERC signal output reset command <ERCRST: Control command> Turn OFF the ERC signal	[Control command] 25h
Set automatic output for the ERC signal <Set EROE (bit 10) in RENV1> 1: Does not output an ERC signal when stopped by EL, ALM, or $\overline{\text{CEMG}}$ input. 1: Automatically outputs an ERC signal when stopped by EL, ALM, or $\overline{\text{CEMG}}$ input.	[RENV1] (WRITE) 15 8 - - - - n - -
Set automatic output for the ERC signal <Set EROR (bit 11) in RENV1> 0: Does not output an ERC signal at the completion of a zero return operation. 1: Automatically outputs an ERC signal at the completion of a zero return operation.	[RENV1] (WRITE) 15 8 - - - - n - -

Set the ERC signal output width <Set EPW0 to 2 (bits 12 to 14) in RENV1> 000: 12 μ sec 100: 13 msec 001: 102 μ sec 101: 52 msec 010: 408 μ sec 110: 104 msec 011: 1.6 msec 111: Logic level output	[RENV1] (WRITE) 15 8 - n n n - - - -
Select output logic for the ERC signal <Set ERCL (bit 15) in RENV1> 0: Negative logic 1: Positive logic	[RENV1] (WRITE) 15 8 n - - - - - - -
Specify the ERC signal OFF timer time <Set ETW0 to 1 (bits 16 to 17) in RENV1> 00: 0 μ sec 10: 1.6 msec 01: 12 μ sec 11: 104 msec	[RENV1] (WRITE) 23 16 - - - - - - n n
Specify the ERC signal OFF timer time <Set ETW0 to 1 (bits 16 to 17) in RENV1> 00: 0 μ sec 10: 1.6 msec 01: 12 μ sec 11: 104 msec	[RENV1] (WRITE) 23 16 - - - - - - n n
Read the ERC signal <SERCRCR (bit 9) in STS> 0: The ERC signal is OFF 1: The ERC signal is ON	[RSTS] (READ) 15 8 0 - - - - - n -

11-6-3. ALM signals

Input alarm (ALM) signal.

When the ALM signal turns ON while in operation, the axis will stop immediately or decelerate and stop. To stop using deceleration, keep the ALM input ON until the axis stops operation.

However, the axis only decelerates and stops on an ALM signal if it was started with a high speed start. If the ALM signal is ON when a start command is written, the LSI will not output any pulses.

The minimum pulse width of the ALM signal is 80 reference clock cycles (4 μ sec) if the input filter is ON. If the input filter is OFF, the minimum pulse width is 2 reference clock cycles (0.1 μ sec). (When CLK = 19.6608 HMz.)

The input logic of the ALM signal can be changed. The signal status of the ALM signal can be monitored by reading SSTS (sub status).

Stop method when the ALM signal is ON <Set ALMM (bit 8) in RENV1> 0: Stop immediately when the ALM signal is turned ON 1: Deceleration stop (high speed start only) when the ALM signal is turned ON	[RENV1] (WRITE) 15 8 - - - - - - - n
Input logic setting of the ALM signal <Set ALML (bit 9) in RENV1> 0: Negative logic 1: Positive logic	[RENV1] (WRITE) 15 8 - - - - - - n -
Read the ALM signal <SALM (bit 11) in SSTS> 0: The ALM signal is OFF 1: The ALM signal is ON	[SSTS] (READ) 15 8 - - - - n - - -
Reading the cause of a stop when the ALM signal is turned ON <ESAL (bit 7) in RESET> 1: Stop due to the ALM signal being turned ON	[REST] (READ) 7 0 n - - - - - - -
Set the ALM input filter <Set FLTR (bit 26) in RENV1> 1: Apply a filter to the ALM input When a filter is applied, pulses less than 4 μ sec pulse in width will be ignored.	[RENV1] (WRITE) 31 24 - - - - - n - -

11-7. External start, simultaneous start

11-7-1. \overline{CSTA} signal

This LSI can start when triggered by an external signal on the \overline{CSTA} terminals. Set MSY (bits 18 and 19) = 01 in the PRDM register (operation mode) and the LSI will start feeding when the \overline{CSTA} goes LOW. When you want to control multiple axes using more than one LSI, connect the \overline{CSTA} terminal on each LSI and set the axes to "waiting for \overline{CSTA} input", to start them all at the same time. In this example a start signal can be output through the \overline{CSTA} terminal.

The input logic on the \overline{CSTA} terminals cannot be changed.

By setting the RIRQ register (event interrupt cause), the \overline{INT} signal can be output together with a simultaneous start (when the \overline{CSTA} input is ON). By reading the RIST register, the cause of an event interrupt can be checked.

The operation status (waiting for \overline{CSTA} input), and status of the \overline{CSTA} terminal (OR of the \overline{CSTA} signals) can be monitored by reading the RIST register, or RSTS register (extension status), respectively.

<How to make a simultaneous start>

Set MSY0 to 1 (bits 18 and 19) in the RMD register for the axes you want to start. Write a start command and put the LSI in the "waiting for \overline{CSTA} input" status. Then, start the axes simultaneously by either of the methods described below.

- 1) By writing a simultaneous start command, the LSI will output a one shot signal of 8 reference clock cycles (approx. 0.4 μ sec when CLK = 19.6608 MHz) from the \overline{CSTA} terminal.
- 2) Input hardware signal from outside.
Supply a hardware signal by driving the terminal with open collector output (74LS06 or equivalent).

\overline{CSTA} signals can be supplied as level trigger or edge trigger inputs. However, when level trigger input is selected, if $\overline{CSTA} = L$ or a start command is written, the axis will start immediately.

After connecting the \overline{CSTA} terminals on each LSI, each axis can still be started independently using start commands.

To release the "waiting for \overline{CSTA} input" condition, write an immediate stop command (49h).

- 1) To start axes controlled by different LSIs simultaneously, connect the LSIs as follows.

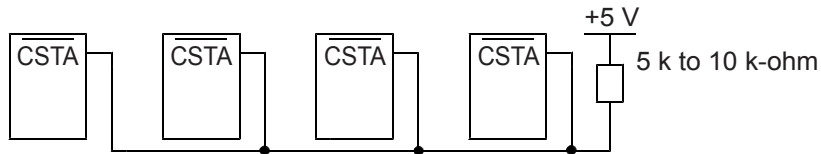

- 2) To start simultaneously from an external circuit, or use a single axis as an external start, connect the LSIs as follows.

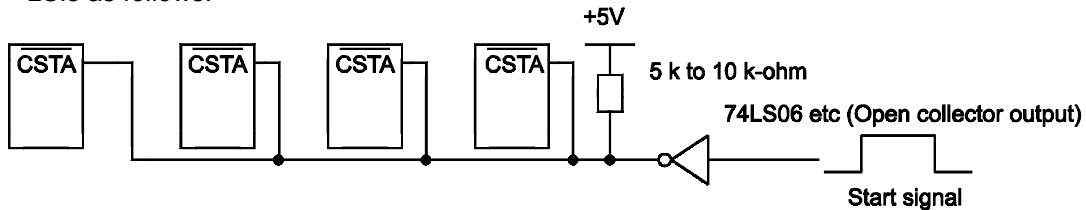

For start signal, supply a one shot input signal with a pulse width of at least 4 reference clock cycles (approx. 0.2 μ sec when CLK = 19.6608 MHz).

\overline{CSTA} input <MSY0 to 1 (bits 18 and 19) in PRMD> 01: Start by inputting a \overline{CSTA} signal	[RMD] (WRITE) 23 16 - - - - n n - -
Specify the input specification for the \overline{CSTA} signal <Set STAM (bit 18) in RENV1> 0: Level trigger input for the \overline{CSTA} signal 1: Edge trigger input for the \overline{CSTA} signal	[RENV1] (WRITE) 23 16 - - - - - n - -
Read the \overline{CSTA} signal <SSTA (bit 5) in RSTS> 0: The \overline{CSTA} signal is OFF 1: The \overline{CSTA} signal is ON	[RSTS] (READ) 7 0 - - n - - - - -
Read the operation status <CND (bits 0 to 3) in RSTS> 0010: Waiting for \overline{CSTA} input	[RSTS] (READ) 7 0 - - - - n n n n
Set an event interrupt cause <Set IRSA (bit 18) in RIRQ> 1: Output an \overline{INT} signal when the \overline{CSTA} input is ON.	[RIRQ] (WRITE) 23 16 0 0 0 0 0 n - -
Reading the event interrupt cause <ISSA (bit 19) in RIST> 1: When the \overline{CSTA} signal is ON.	[RIST] (READ) 23 16 0 0 0 0 n - - -
Simultaneous start command <CMSTA: Operation command> Output a one shot pulse 8 reference clock cycles long from the \overline{CSTA} terminal. (The \overline{CSTA} terminal is bi-directional. It can receive signals output from other PCLs.)	[Operation command] 06h
Local axis only, simultaneous start command <SPSTA: Operation command> Used the same way as when a \overline{CSTA} signal is supplied, for a local axis only.	[Operation command] 2Ah

11-7-2. PCS signal

The PCS input is a terminal originally used for the target position override 2 function. By setting the MSY (bits 18 & 19) to "01" in the PRMD (operation mode) register, the PCS input signal can enable the \overline{CSTA} signal for only its own axis.

The input logic of the PCS input signal can be changed. The terminal status can be monitored by reading the RSTS register (extension status).

Specify the function of the PCS signal <Set PCSM (bit 30) in RENV1> 1: Make PCS input effective on only the local axis.	[RENV1] (WRITE) 31 24 - n - - - - - -
Set the Waiting for \overline{CSTA} input <Set MSY0 to 1 (bits 18 and 19) in RMD> 01: Start on a \overline{CSTA} input.	[RMD] (WRITE) 23 16 - - - - - n n - -
Set the input logic of the PCS signal <Set PCSL (bit 24) in RENV1> 0: Negative logic 1: Positive logic	[RENV1] (WRITE) 31 24 - - - - - - - n
Read the PCS signal <SPCS (bit 8) in RSTS> 0: The PCS signal is OFF 1: The PCS signal is ON	[RSTS] (READ) 15 8 - - - - - - - n

11-8. External stop / simultaneous stop

This LSI can execute an immediate stop or a deceleration stop triggered by an external signal using the $\overline{\text{CSTP}}$ terminal. Set MSPE (bit 24) = 1 in the PRMD register (operation mode) to enable a stop from a $\overline{\text{CSTP}}$ input. The axis will stop immediately or decelerate and stop when the $\overline{\text{CSTP}}$ terminal is LOW. However, a deceleration stop is only used for a high speed start. When the axis is started at low speed, the signal on the $\overline{\text{CSTP}}$ terminal will cause an immediate stop.

The input logic of the $\overline{\text{CSTP}}$ terminal cannot be changed.

When multiple LSIs are used to control multiple axes, connect all of the $\overline{\text{CSTP}}$ terminals from each LSI and input the same signal so that the axes which are set to stop on a $\overline{\text{CSTP}}$ input can be stopped simultaneously. In this case, a stop signal can also be output from the $\overline{\text{CSTP}}$ terminal.

When an axis stops because the $\overline{\text{CSTP}}$ signal is turned ON, an $\overline{\text{INT}}$ signal can be output. By reading the REST register, you can determine the cause of an error interrupt. You can monitor $\overline{\text{CSTP}}$ terminal status by reading the RSTS register (extension status).

<How to make a simultaneous stop>

Set MSPE (bit 24) = 1 in the PRMD register for each of the axes that you want to stop simultaneously. Then start these axes.

Stop these axes using either of the following two methods.

- 1) By writing a simultaneous stop command, the $\overline{\text{CSTP}}$ terminal will output a one shot signal 8 reference clock cycles in length (approx. 0.4 μsec when CLK = 19.6608 MHz).
- 2) Supply an external hardware signal
Supply a hardware signal using an open collector output (74LS06 or equivalent).
- 3) The $\overline{\text{CSTP}}$ terminal will output a one shot signal for 8 reference clock cycles (approximately 0.4 μsec when CLK = 19.6608 MHz) when a stop caused by an error occurs on an axis that has MSPO = 1 in the PRMD register.

Even when the $\overline{\text{CSTP}}$ terminals on LSIs are connected together, each axis can still be stopped independently by using the stop command.

- 1) Connect the terminals as follows for a simultaneous stop among different LSIs.

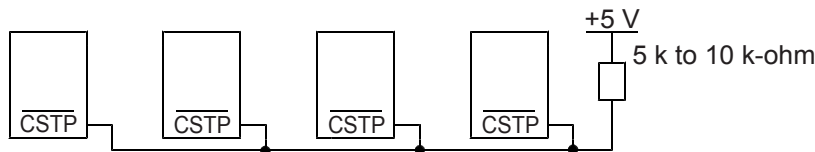

- 2) To stop simultaneously using an external circuit, connect as follows.

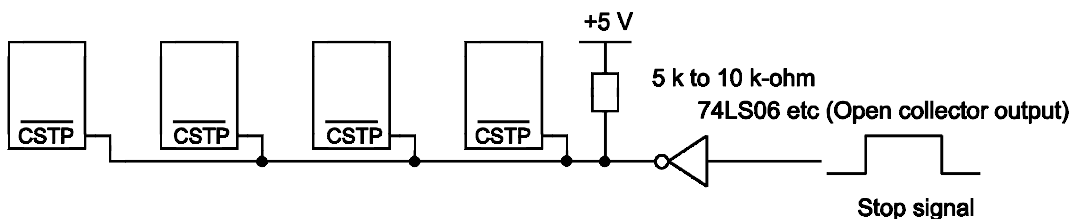

As a stop signal, supply a one shot signal 4 reference clock cycles or more in length (approx. 0.2 μsec when CLK = 19.6608 MHz).

Setting to enable $\overline{\text{CSTP}}$ input <Set MSPB (bit 24) in PRMD> 1. Enable a stop from the $\overline{\text{CSTP}}$ input. (Immediate stop, deceleration stop)	[PRMD] (WRITE) 31 24 0 0 0 0 - - - n
Auto output setting for the $\overline{\text{CSTP}}$ signal <Set to MSPO (bit 25) in the PRMD> 1: When an axis stops because of an error, the PCL will output the $\overline{\text{CSTP}}$ signal. (Output signal width: 8 reference clock cycles)	[PRMD] (WRITE) 31 24 0 0 0 0 - - - n

Specify the stop method to use when the $\overline{\text{CSTP}}$ signal is turned ON. <Set STPM (bit 19) in RENV1> 0: Immediate stop when the $\overline{\text{CSTP}}$ signal is turned ON. 1: Deceleration stop when the $\overline{\text{CSTP}}$ signal is turned ON.	[RENV1] (WRITE) 23 16 - - - - n - - -
Read the $\overline{\text{CSTP}}$ signal <SSTP (bit 6) in RSTS> 0: The $\overline{\text{CSTP}}$ signal is OFF 1: The $\overline{\text{CSTP}}$ signal is ON	[RSTS] (READ) 7 0 - n - - - - - -
Read the cause of an error input <ESSP (bit 8) in REST> 1. When stopped because the $\overline{\text{CSTP}}$ signal turned ON.	[REST] (READ) 15 8 - - - - - - n
Simultaneous stop command <CMSTP: Operation command> Outputs a one shot pulse of 8 reference clock cycles in length from the $\overline{\text{CSTP}}$ terminal. (The $\overline{\text{CSTP}}$ terminal is bi-directional. It can receive signals output from other PCLs.)	[Operation command] 07h

11-9. Emergency stop

This LSI has a $\overline{\text{CEMG}}$ input terminal for use as an emergency stop signal.

While in operation, if the $\overline{\text{CEMG}}$ input goes LOW or if you write an emergency stop command, all the axes will stop immediately. While the $\overline{\text{CEMG}}$ input remains LOW, no axis can be operated.

The logical input of the $\overline{\text{CEMG}}$ terminal cannot be changed.

When the axes are stopped because the $\overline{\text{CEMG}}$ input was turned ON, the LSI will output an INT signal. By reading the REST register, the cause of the error interruption can be determined.

The status of the $\overline{\text{CEMG}}$ terminal can be monitored by reading the REST register (extension status).

Read the $\overline{\text{CEMG}}$ signal <SEMG (bit 7) in RSTS> 0: The $\overline{\text{CEMG}}$ signal is OFF 1: The $\overline{\text{CEMG}}$ signal is ON	[RSTS] (READ) 7 0 n - - - - - -
Read the cause of an error interrupt <ESEM (bit 9) in REST> 1. Stopped when the $\overline{\text{CEMG}}$ signal was turned ON.	[REST] (READ) 16 8 - - - - - n -
Emergency stop command <CMEMG: Operation command> The operation is the same as when a $\overline{\text{CEMG}}$ signal is input.	[Operation command] 05h

Note: In a normal stop operation, the final pulse width is normal. However, in an emergency stop operation, the final pulse width may not be normal. It can be triangular. Motor drivers do not recognize triangle shaped pulses, and therefore only the PCL counter may count this pulse. (Deviation from the instructed position control). Therefore, after an emergency stop, you must perform a zero return to match the instructed position with the mechanical position.

11-10. Counter

11-10-1. Counter type and input method

In addition to the positioning counter, this LSI contains four other counters. These counters offer the following functions.

- ◆ Control command position and mechanical position
- ◆ Detect a stepper motor that is "out of step" using COUNTER3 (deflection counter) and a comparator.
- ◆ Output a synchronous signal using COUNTER4 (general-purpose) and a comparator.

The positioning counter is loaded with an absolute value for the RMV register (target position) with each start command, regardless of the operation mode selected. It decreases the value with each pulse that is output. However, if MPCS (bit 14) of the RMD register (operation mode) is set to 1 and a position override 2 is executed, the counter does not decrease until the PCS input turned ON.

Input to COUNTER1 is exclusively for output pulses. However COUNTERS2 to 4 can be selected as follows by setting the RENV3 register (environment setting 3).

	COUNTER1	COUNTER2	COUNTER3	COUNTER4
Counter name	Command position	Mechanical position	Deflection	General-purpose
Counter type	Up/down counter	Up/down counter	Deflection counter	Up/down counter
Number of bits	28	28	16	28
Output pulse	Possible	Possible	Possible	Possible
Encoder (EA/EB) input	Not possible	Possible	Possible	Possible
Pulsar (PA/PB) input	Not possible	Possible	Possible	Possible
1/2 of reference clock	Not possible	Not possible	Not possible	Not possible

Note: When using pulsar input, use the internal signal result after multiplying or dividing.

Specify COUNTER2 (mechanical position) input <CI20 to 21 (bit 8 & 9) in RENV3> 00: EA/EB input 01: Output pulses 10: PA/PB input	[RENV3] (WRITE) 15 8 - - - - - n n
Set COUNTER3 (deflection) input <CI30 to 31 (bit 10 & 11) in RENV3> 00: Measure the deflection between output pulses and EA/EB input 01: Measure the deflection between output pulses and PA/PB input 10: Measure the deflection between EA/EB input and PA/PB input	[RENV3] (WRITE) 15 8 - - - - n n - -
Set COUNTER4 (general-purpose) input <CI40 to 41 (bit 12 & 13) in RENV3> 00: Output pulses 01: EA/EB input 10: PA/PB input 11: Reference clock (CLK) / 2.	[RENV3] (WRITE) 15 8 - - n n - - - -

The EA/EB and PA/PB input terminal, that are used as inputs for the counter, can be set for one of two signal input types by setting the RENV2 (environment setting 2) register.

1) Signal input method: Input 90° phase difference signals (1x, 2x, 4x)

Counter direction: Count up when the EA input phase is leading. Count down when the EB input phase is leading.

2) Signal input method: Input 2 sets of positive and negative pulses.

Counter direction: Count up on the rising edge of the EA input. Count down on the falling edge of the EB input.

The counter direction or EA/EB and PA/PB input signals can be reversed.

The LSI can be set to sense an error when both the EA and EB input, or both the PA and PB inputs change simultaneously, and this error can be detected using the REST (error interrupt cause) register.

Set the input signal filter for EA/EB/EZ <Set EINF (bit 18) in RENV2> 0: Turn OFF the filter function 1: Turn ON the filter function (Input signals shorter than 3 reference clock cycles are ignored.)	[RENV2] (WRITE) 23 16 - - - - - n - -
Setting the EA/EB input <Set EIM0 to 1 (bit 20 & 21) in RENV2> 00: 90° phase difference, 1x 10: 90° phase difference, 4x 01: 90° phase difference, 2x 11: 2 sets of up or down input pulses	[RENV2] (WRITE) 23 16 - - n n - - - -
Specify the EA/EB input count direction <Set to EDIR (bit 22) in RENV2> 0: Count up when the EA phase is leading. Or, count up on the rising edge of EA. 1: Count up when the EB phase is leading. Or, count up on the rising edge of EB.	[RENV2] (WRITE) 23 16 - n - - - - - -
Enable/disable EA/EB input <Set EOFF (bit 30) in RENV2> 0: Enable EA/EB input 1: Disable EA/EB input. (EZ input is valid.)	[RENV2] (WRITE) 31 24 - n - - - - - -
Set the input signal filter for PA/PB <Set PINF (bit 19) in RENV2> 0: Turn OFF the filter function. 1: Turn ON the filter function (Input signals shorter than 3 reference clock cycles are ignored.)	[RENV2] (WRITE) 23 16 - - - - - n - - - -
Specify the PA/PB input <Set to PIM0 to 1 (bit 24 & 25) in RENV2> 00: 90° phase difference, 1x 10: 90° phase difference, 4x 01: 90° phase difference, 2x 11: 2 sets of up or down input pulses	[RENV2] (WRITE) 31 24 - - - - - - n n
Specify the PA/PB input count direction <Set to PDIR (bit 26) in RENV2> 0: Count up when the PA phase is leading. Or, count up on the rising edge of PA. 1: Count up when the PB phase is leading. Or, count up on the rising edge of PB.	[RENV2] (WRITE) 31 24 - - - - - n - - - -
Enable/disable PA/PB input <Set POFF (bit 31) in RENV2> 0: Enable PA/PB input 1: Disable PA/PB input.	[RENV2] (WRITE) 31 24 n - - - - - - - -
Reading EA/EB, PA/PB input error <ESEE (bit 16), ESPE (bit 17) in the REST> ESEE (bit 16) = 1: An EA/EB input error occurred. ESPE (bit 17) = 1: An PA/PB input error occurred.	[REST] (READ) 23 16 0 0 0 0 0 0 n n

When EDIR is "0," the EA/EB input and count timing will be as follows.
For details about the PA/PB input, see section "9-3. Pulsar input mode."

1) When using 90° phase difference signals and 1x input

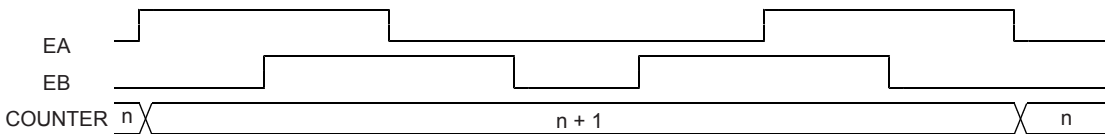

2) When using 90° phase difference signals and 2x input

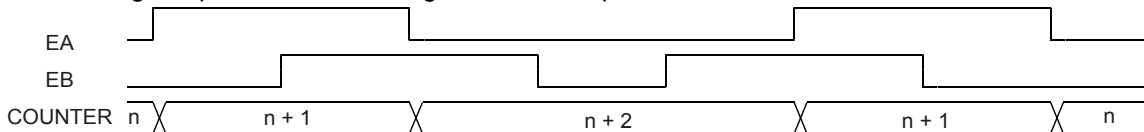

3) When using 90° phase difference signals and 4x input

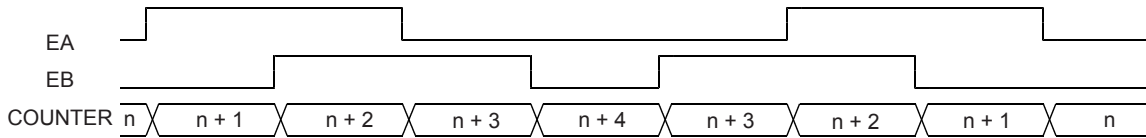

4) When two pulses are input (counted on the rising edge)

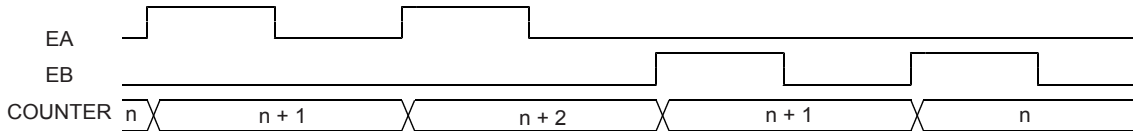

11-10-2. Counter reset

All the counters can be reset using any of the following three methods.

- 1) When the CLR input signal turns ON (set in RENV3).
- 2) When a zero return is executed (set in RENV3).
- 3) When a command is written.

The PCL can also be specified to reset automatically, soon after latching the counter value.

The CLR input timing can be set in RENV1 (environment setting 1). An \overline{INT} signal can be output when a CLR input is the cause of an event interrupt.

Action when the CLR signal turns ON <Set CU1C to 4C (bit 16 to 19) in the RENV3> CU1C (bit 16) = 1: Reset COUNTER1 (command position). CU2C (bit 17) = 1: Reset COUNTER2 (mechanical position). CU3C (bit 18) = 1: Reset COUNTER3 (deflection). CU4C (bit 19) = 1: Reset COUNTER4 (general-purpose).	[RENV3] (WRITE) 23 16 - - - - n n n n
Action when a zero return is complete <Set CU1R to 4R (bit 20 to 23) in RENV3> CU1R (bit 20) = 1: Reset COUNTER1 (command position). CU2R (bit 21) = 1: Reset COUNTER2 (mechanical position). CU3R (bit 22) = 1: Reset COUNTER3 (deflection). CU4R (bit 23) = 1: Reset COUNTER4 (general-purpose).	[RENV3] (WRITE) 23 16 n n n n - - - -
Setting when latched <Set CU1L to 4L (bits 24 to 27) in RENV5> CU1L (bit 24) = 1: Reset COUNTER1 (instructed position). CU2L (bit 25) = 1: Reset COUNTER2 (machine position). CU3L (bit 26) = 1: Reset COUNTER3 (deviation). CU4L (bit 27) = 1: Reset COUNTER4 (general-purpose).	[RENV5] (WRITE) 31 24 0 0 0 0 n n n n
Action for the CLR signal <Set CLR0 and 1 (bit 20 & 21) in RENV1> 00: Clear on the falling edge 10: Clear on a LOW level 01: Clear on the rising edge 11: Clears on a HIGH level	[RENV1] (WRITE) 23 16 - - n n - - - -
Reading the CLR signal <SCLR (bit 13) in RSTS> 0: The CLR signal is OFF 1: The CLR signal is ON	[RSTS] (READ) 15 8 - - n - - - - -
Set event interrupt cause <Set IRCL (bit 13) in RIRQ> 1: Output an \overline{INT} signal when resetting the counter value by turning the CLR signal ON.	[RIRQ] (WRITE) 15 8 - - n - - - - -
Read the event interrupt cause <ISCL (bit 13) in RIST> 1: When you want to reset the counter value by turning ON the CLR signal.	[RIST] (READ) 15 8 - - n - - - - -
Counter reset command <CUN1R to CUN4R: Control command> 20h: Set COUNTER1 (command position) to zero 21h: Set COUNTER2 (mechanical position) to zero. 22h: Set COUNTER3 (deflection) to zero. 23h: Set COUNTER4 (general-purpose) to zero	[Control command] 20h 21h 22h 23h

Note: In order to prevent incorrect counts, when the count timing and reset timing match, the counter will be +1 or -1, never 0. Please note this operation detail when detecting 0 with the comparator function.

11-10-3. Latch the counter and count condition

All the counters can latch their counts using any of the following methods. The setting is made in RENV5 (environment setting 5) register. The latched values can be output from the RLTC1 to 4 registers.

- 1) Turn ON the LTC signal.
- 2) Turn ON the ORG signal.
- 3) When the conditions for Comparator 4 are satisfied.
- 4) When the conditions for Comparator 5 are satisfied.
- 5) When a command is written.

The current speed can also be latched instead of COUNTER3 (deflection). Items 1) to 4) above can also be latched by hardware timing.

The LTC input timing can be set by in RENV1 (environment setting 1). An \overline{INT} signal can be output when a counter value is latched by turning ON the LTC signal or the ORG signal. This allows you to identify the cause of an event interrupt.

Specify the latch method for a counter (1 to 4) <Set LTM0 to 1 (bit 12 to 13) in RENV5> 00: Turn ON the LTC signal. 01: Turn ON the ORG signal. 10: When the conditions for Comparator 4 are satisfied. 11: When the conditions for Comparator 5 are satisfied	[RENV5] (WRITE) 15 8 - - n n - - - -
Specify the latch method for the current speed <Set LTFD (bit 14) in RENV5> 1: Latch the current speed instead of COUNTER 3 (deflection).	[RENV5] (WRITE) 15 8 - n - - - - - -
Specify latching using hardware <Set LTOF (bit 15) in RENV5> 1: Do not latch 1) to 4) above with hardware timing.	[RENV5] (WRITE) 15 8 n - - - - - -
Specify the LTC signal mode <Set LTCL (bit 23) in RENV1> 0: Latch on the falling edge. 1: Latch on the rising edge.	[RENV1] (WRITE) 23 16 n - - - - - -
Set an event interrupt cause <Set IRLT (bit 14) and IROT (bit 15) in RIRQ> IRLT = 1: Output an \overline{INT} signal when the counter value is latched by the LTC signal being turned ON. IROT = 1: Output an \overline{INT} signal when the counter value is latched by the ORG signal being turned ON.	[RIRQ] (WRITE) 15 8 n n - - - - - -
Read the event interrupt cause <ISLT (bit 14), ISOL (bit 15) in RIST> ISLT = 1: Latch the counter value when the LTC signal turns ON. ISOL = 1: Latch the counter value when the ORG signal turns ON.	[RIST] (READ) 15 8 n n - - - - - -
Read the LTC signal <SLTC (bit 14) in RSTS> 0: The LTC signal is OFF 1: The LTC signal is ON	[RSTS] (READ) 15 8 - n - - - - - -
Counter latch command <LTCH: Control command> Latch the contents of the counters (COUNTER1 to 4).	[Control command] 29h

11-10-4. Stop the counter

COUNTER1 (command position) stops when the PRMD (operation mode) register is set to stop the counter while in timer mode operation.

COUNTER2 (mechanical position), COUNTER3 (deflection), and COUNTER4 (general-purpose) stop when the RENV3 (environment setting 3) register is set to stop.

By setting the RENV3 register, you can stop counting pulses while performing a backlash or slip correction.

COUNTER4 (general-purpose) can be set to count only during operation (BSY = low) using the RENV3 register. By specifying 1/2 of the CLK (reference clock) signal, the time after the start can be controlled.

Stopping COUNTER1 (command) <Set MCCE (bit 11) in RMD> 1. Stop COUNTER1 (command position).	[RMD] (WRITE) 15 8 - - - - n - - -
Specify the counting operation for COUNTERS 2 to 4 <Set CU2H to 4H (bits 29 to 31) in RENV3> CU2H (bit 29) = 1: Stop COUNTER2 (mechanical position) CU3H (bit 30) = 1: Stop COUNTER3 (deflection) CU4H (bit 31) = 1: Stop COUNTER4 (general-purpose)	[RENV3] (WRITE) 31 24 n n n 0 - - - -
Setting the counters for backlash or slip correction <Set CU1B to 4B (bits 24 to 27) in RENV3> CU1B (bit 16) = 1: Enable COUNTER1 (command position) CU2B (bit 17) = 1: Enable COUNTER2 (mechanical position) CU3B (bit 18) = 1: Enable COUNTER3 (deflection) CU4B (bit 19) = 1: Enable COUNTER4 (general-purpose)	[RENV3] (WRITE) 31 24 - - - 0 n n n n
Specify the counting conditions for COUNTER4 <Set BSYC (bit 14) in RENV3> 1. Enable COUNTER4 (general-purpose) only while operating (BSY = L).	[RENV3] (WRITE) 15 8 - n - - - - - -

11-11. Comparator

11-11-1. Comparator types and functions

This LSI has 5 circuits/axes using 28-bit comparators. It compares the values set in the RCMP1 to 5 registers with the counter values.

Comparators 1 to 4 can be used as comparison counters and can be assigned as COUNTERS 1 to 4. Comparator 5 can be assigned as COUNTER 1 to 4, a positioning counter, or to track the current speed. There are many comparison methods and four processing methods that can be used when the conditions are met.

Specify the comparator conditions in the RENV4 (environment 4) and RENV5 (environment 5) registers. By using these comparators, you can perform the following.

- ◆ Use comparators for INT outputs, external output of comparison data, and for internal synchronous starts
- ◆ Immediate stop and deceleration stop operations.
- ◆ Change operation data to pre-register data (used to change speed while operating).
- ◆ Software limit function using Comparators 1 and 2.
- ◆ Ring count function using COUNTER1 (command position) and Comparator 1.
- ◆ Ring count function using COUNTER2 (mechanical position) and Comparator 2.
- ◆ Set up a software limit function.
- ◆ Detect out of step stepper motors using COUNTER3 (deflection) and a comparator.
- ◆ Output a synchronous signal (IDX) using COUNTER4 (general-purpose) and a comparator.

Comparator 5 is equipped with a pre-register. It too can output an INT signal when the comparator's conditions are satisfied.

[Comparison data] Each comparator can select the data for comparison from the items in the following table.

Comparison data	Comparator 1		Comparator 2		Comparator 3		Comparator 4		Comparator 5	
	C1C0 to 1		C2C0 to 1		C3C0 to 1		C4C0 to 1		C5C0 to 2	
COUNTER1 (command position)	O	"00"	O	"00"	O	"00"	O	"00"	O	"000"
COUNTER2 (mechanical position)	O	"01"	O	"01"	O	"01"	O	"01"	O	"001"
COUNTER3 (deflection)	O	"10"	O	"10"	O	"10"	O	"10"	O	"010"
COUNTER4 (general-purpose)	O	"11"	O	"11"	O	"11"	O	"11"	O	"011"
Positioning counter									O	"100"
Current speed									O	"101"
Pre-register	None		None		None		None		Yes	
Major application	+SL		-SL				IDX output			
	Use COUNTER1 as a ring counter		Use COUNTER1 as a ring counter							

- O: Comparison possible. Blank: Comparison not possible.

- +SL, -SL are used for software limits.

- If COUNTER3 (deflection) is selected as the comparison counter, the LSI will compare the absolute value of the counter with the comparator data. (Absolute value range: 0 to 32,767)

- The bit assignments of the comparison data settings are as follows:

C1C0 to 1 (RENV4 bits 0 & 1), C2C0 to 1 (RENV4 bits 8 & 9), C3C0 to 1 (RENV4 bits 16 & 17), C4C0 to 1 (RENV4 bits 24 & 25), C5C0 to 2 (RENV5 bits 0 to 2)

[Comparison method] Each comparator can be assigned a comparison method from the table below.

Comparison method	Comparator 1		Comparator 2		Comparator 3		Comparator 4		Comparator 5	
	C1S0 to 2	C1RM	C2S0 to 2	C1RM	C3S0 to 2		C4S0 to 3		C5S0 to 2	
Comparator = Comparison counter (regardless of count direction)	O "001"	'0'	O "001"	'0'	O "001"		O "0001"		O "001"	
Comparator = Comparison counter (Count up only)	O "010"	'0'	O "010"	'0'	O "010"		O "0010"		O "010"	
Comparator = Comparison counter (count down only)	O "011"	'0'	O "011"	'0'	O "011"		O "0011"		O "011"	
Comparator > Comparison counter	O "100"	'0'	O "100"	'0'	O "100"		O "0100"		O "100"	
Comparator < Comparison counter	O "101"	'0'	O "101"	'0'	O "101"		O "0101"		O "101"	
Use for software limits	O "110"	'0'	O "110"	'0'						
IDX (synchronous signal) output (regardless of counting direction)							O "1000"			
IDX (synchronous signal) output (count up only)							O "1001"			
IDX (synchronous signal) output (count down only)							O "1010"			
Use COUNTER1 as a ring counter	O "001"	'1'					O "1010"			
Use COUNTER1 as a ring counter			O "001"	'1'			O "1010"			

- O: Comparison possible. Blank: Comparison not possible.
- When used for software limits, Comparator 1 is a positive direction limit and the comparison method is comparator < comparison counter. Comparator 2 is the negative limit value and the comparison method is comparator > comparison counter. Select COUNTER1 (command position) for the comparison counter.
- Comparator 3 must not have C3S0 to 2 set to a value of 110. Setting any of the values may result in failing to satisfy the comparison conditions.
- When C4S0 to 3 = 1000 to 1010 for Comparator 4 <IDX (synchronous signal) output>, select COUNTER4 (general-purpose) for use as the comparison counter. Other counters cannot be used for this function. Enter a positive value for the comparator setting.
- The bit assignments for various comparison methods are as follows:
C1S0 to 2 (RENV4 bits 2 to 4), C2S0 to 2 (RENV4 bits 10 to 12), C3S0 to 1 (RENV4 bits 18 to 20), C4S0 to 3 (RENV4 bits 26 to 29), C5S0 to 2 (RENV5 bits 3 to 5)

[Processing method when comparator conditions are satisfied] The processing method that is used when the conditions are satisfied can be selected from the table below.

Processing method when the conditions are met	Comparator 1	Comparator 2	Comparator 3	Comparator 4	Comparator 5
	C1D0 to 1	C2D0 to 1	C3D0 to 1	C4D0 to 1	C5D0 to 1
Do nothing	"00"	"00"	"00"	"00"	"00"
Immediate stop operation	"01"	"01"	"01"	"01"	"01"
Deceleration stop operation	"10"	"10"	"10"	"10"	"10"
Change operation data to pre-register data	"11"	"11"	"11"	"11"	"11"

- "Do nothing" is mainly used for INT output, external output of comparison result, or internal synchronous starts.
- To change the speed pattern while in operation, change the operation data to the values stored as pre-register data. The PRMV setting will also be transferred to the RMV. However, this does not affect operation.
- The bit assignments to select a processing method are as follows.
C1D0 to 1 (RENV4 bits 5 & 6), C2D0 to 1 (RENV4 bits 13 & 14), C3D0 to 1 (RENV4 bits 21 & 22), C4D0 to 1 (RENV4 bits 30 & 31), C5D0 to 1 (RENV5 bits 6 & 7)

[How to set the INT output, external output of comparison results, and internal synchronous starting]

<p>Set an event interrupt cause <Set IRC1 to 5 (bit 8 to 12) in RIRQ></p> <p>IRC1 (bit 8) = 1: Output $\overline{\text{INT}}$ signal when the Comparator 1 conditions are satisfied.</p> <p>IRC2 (bit 9) = 1: Output $\overline{\text{INT}}$ signal when the Comparator 2 conditions are satisfied.</p> <p>IRC3 (bit 10) = 1: Output $\overline{\text{INT}}$ signal when the Comparator 3 conditions are satisfied.</p> <p>IRC4 (bit 11) = 1: Output $\overline{\text{INT}}$ signal when the Comparator 4 conditions are satisfied.</p> <p>IRC5 (bit 12) = 1: Output $\overline{\text{INT}}$ signal when the Comparator 5 conditions are satisfied.</p>	<p>[RIRQ] (WRITE)</p> <p>15 8</p> <p>- - - n n n n n</p>
<p>Read the event interrupt cause <ISC1 to 5 (bit 8 to 12) in RIST></p> <p>IRC1 (bit 8) = 1: When the Comparator 1 conditions are satisfied.</p> <p>IRC2 (bit 9) = 1: When the Comparator 2 conditions are satisfied.</p> <p>IRC3 (bit 10) = 1: When the Comparator 3 conditions are satisfied.</p> <p>IRC4 (bit 11) = 1: When the Comparator 4 conditions are satisfied.</p> <p>IRC5 (bit 12) = 1: When the Comparator 5 conditions are satisfied.</p>	<p>[RIST] (READ)</p> <p>15 8</p> <p>- - - n n n n n</p>
<p>Read the comparator condition status <SCP1 to 5 (bits 8 to 12) in MSTSW></p> <p>SCP1 (bit 8) = 1: When the Comparator 1 conditions are satisfied.</p> <p>SCP2 (bit 9) = 1: When the Comparator 2 conditions are satisfied.</p> <p>SCP3 (bit 10) = 1: When the Comparator 3 conditions are satisfied.</p> <p>SCP4 (bit 11) = 1: When the Comparator 4 conditions are satisfied.</p> <p>SCP5 (bit 12) = 1: When the Comparator 5 conditions are satisfied.</p>	<p>[MSTSW] (READ)</p> <p>15 8</p> <p>- - - n n n n n</p>
<p>Specify the P3/CP1 (+SL) terminal specifications <P3M0 to 1 (bits 6 & 7) in RENV2></p> <p>00: General-purpose input</p> <p>01: General-purpose output</p> <p>10: Output a CP1 (Comparator 1 conditions satisfied) signal using negative logic.</p> <p>11: Output a CP1 (Comparator 1 conditions satisfied) signal using positive logic.</p>	<p>[RENV2] (WRITE)</p> <p>7 0</p> <p>n n - - - - -</p>
<p>Specify the P4/CP2 (-SL) terminal specifications <P4M0 to 1 (bits 8 & 9) in RENV2></p> <p>00: General-purpose input</p> <p>01: General-purpose output</p> <p>10: Output CP2 (Comparator 2 conditions satisfied) signal using negative logic.</p> <p>11: Output CP2 (Comparator 2 conditions satisfied) signal using positive logic.</p>	<p>[RENV2] (WRITE)</p> <p>15 8</p> <p>- - - - - n n</p>
<p>Specify the P5/CP3 terminal specifications <Set P5M0 to 1 (bits 10 & 11) in RENV2></p> <p>00: General-purpose input</p> <p>01: General-purpose output</p> <p>10: Output CP3 (Comparator 3 conditions satisfied) signal using negative logic.</p> <p>11: Output CP3 (Comparator 3 conditions satisfied) signal using positive logic.</p>	<p>[RENV2] (WRITE)</p> <p>15 8</p> <p>- - - - n n - -</p>
<p>Specify the P6/CP4 terminal specifications <Set P6M0 to 1 (bits 12 & 13) in RENV2></p> <p>00: General-purpose input</p> <p>01: General-purpose output</p> <p>10: Output CP4 (Comparator 4 conditions satisfied) signal using negative logic.</p> <p>11: Output CP4 (Comparator 4 conditions satisfied) signal using positive logic.</p>	<p>[RENV2] (WRITE)</p> <p>15 8</p> <p>- - n n - - - -</p>
<p>Specify the P7/CP5 terminal specifications <Set P7M0 to 1 (bits 14 & 15) in RENV2></p> <p>00: General-purpose input</p> <p>01: General-purpose output</p> <p>10: Output CP5 (Comparator 5 conditions satisfied) signal using negative logic.</p> <p>11: Output CP5 (Comparator 5 conditions satisfied) signal using positive logic.</p>	<p>[RENV2] (WRITE)</p> <p>15 8</p> <p>n n - - - - -</p>
<p>Specify the output timing for an internal synchronous signal <Set SYO1 to 3 (bits 16 to 19) in RENV5></p> <p>0001: When the Comparator 1 conditions are satisfied.</p> <p>0010: When the Comparator 2 conditions are satisfied.</p> <p>0011: When the Comparator 3 conditions are satisfied.</p> <p>0100: When the Comparator 4 conditions are satisfied.</p> <p>0101: When the Comparator 5 conditions are satisfied.</p> <p>1000: When the acceleration starts.</p> <p>1001: When the acceleration is complete.</p> <p>1010: When the deceleration starts</p> <p>1011: When the deceleration is complete.</p> <p>Others: Turn OFF internal synchronous output signal</p>	<p>[RENV5] (WRITE)</p> <p>23 16</p> <p>- - - - n n n n</p>

[Speed change using the comparator]

When the comparator conditions are met, you can use the function which changes the operation data to the values stored as pre-register data. This function is used to change the speed when a specified position is reached.

Also, comparator 5 has a pre-register function, and can be specified for use in changing the speed at specified positions. In this case, use the "Pre-register set command (4Fh)," to specify several sets of speed data.

If the speed change data (data used with set commands) are left in Pre-registers 1 and 2 when the current operation completes (Example 1), or if the speed change data is left in Pre-register 1 and some next operation data exists in Pre-register 2 (Example 2), the PCL will ignore the speed change data and shift the data in the pre-registers.

Then, in Example 2, the PCL will start the next operation after shifting the data in the pre-registers.

Example 1

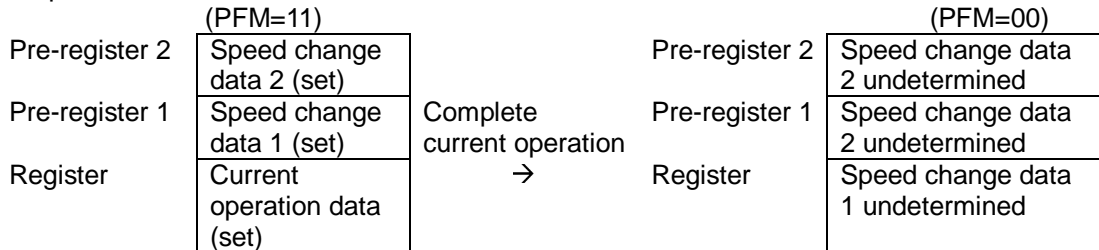

Example 2

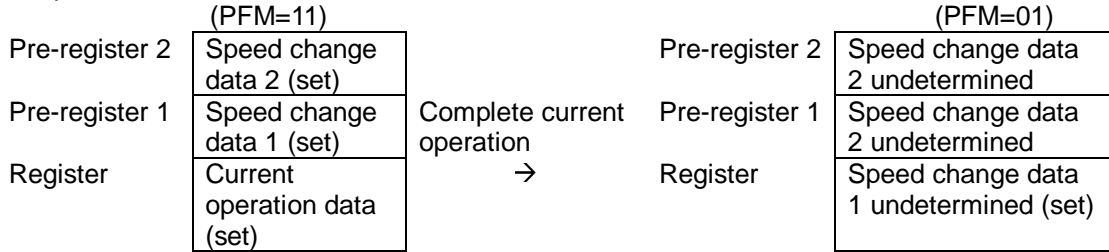

Set a pre-register <PRSET: Operation command>	[Operation command]
Identify the pre-register details as speed change data.	4Fh

11-11-2. Software limit function

A software limit function can be set up using comparators 1 and 2.

Select COUNTER1 (command position) as a comparison counter for comparators 1 and 2.

Use Comparator 1 for a positive direction limit and Comparator 2 for a negative direction limit to stop the axis based on the results of the comparator and the operation direction.

When the software limit function is used the following process can be executed.

- 1) Stop pulse output immediately
- 2) Decelerate and then stop pulse output

While using the software limit function, if a deceleration stop is selected as the process to use when the comparator conditions are met (C1D, C2D), when an axis reaches the software limit while in a high speed start (52h, 53h), that axis will stop using deceleration. When some other process is specified for use when the conditions are met, or while in a low speed start, that axis will stop immediately.

If a software limit is ON while writing a start command, the axis will not start to move in the direction in which the software limit is enabled. However, it can start in the opposite direction.

[Setting example]

RENV4=00003838h: Use Comparator 1 as positive direction software limit. Use Comparator 2 as negative direction software limit.

Set to stop immediately when the software limit is reached.

RCMP1= 100,000: Positive direction limit value

RCMP2= -100,000: Negative direction limit value

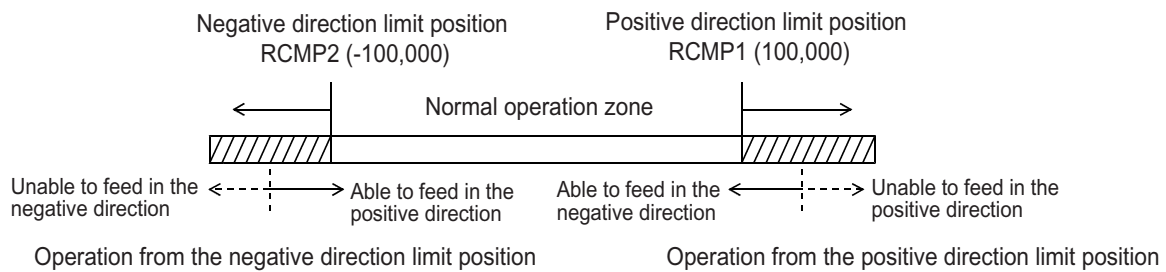

Setting the comparison method for Comparator 1 <Set C1S0 to C1S2 (bits 2 to 4) in RENV4> 110: Use as a positive direction software limit	[RENV4] (WRITE) 7 0 - - - n n n - -
Specify the process to use when the Comparator 1 conditions are met <Set C1D0 to C1D1 (bits 5 & 6) in RENV4> 01: Immediate stop 10: Deceleration stop	[RENV4] (WRITE) 7 0 - n n - - - - -
Specify the comparison method for Comparator 2 <Set C2S0 to C2S2 (bits 10 to 12) in RENV4> 110: Use as a negative direction software limit.	[RENV4] (WRITE) 15 8 - - - n n n - -
Specify the process to use when the Comparator 2 conditions are met <Set C2D0 to C2D1 (bits 13 & 14) in RENV4> 01: Immediate stop 10: Deceleration stop	[RENV4] (WRITE) 15 8 - n n - - - - -

11-11-3. Out of step stepper motor detection function

If the deflection counter value controlled by the motor command pulses and the feed back pulses from an encoder on a stepper motor exceed the maximum deflection value, the LSI will declare that the stepper motor is out of step. The LSI monitors stepper motor operation using COUNTER3 (the deflection counter) and a comparator.

The process which takes place after an out of step condition is detected can be selected from the table. [Processing method to use when the comparator conditions are satisfied].

For this function, use an encoder with the same resolution as the stepper motor.

COUNTER3 (deflection) can be cleared by writing a set command to the deflection counter.

There are two methods for inputting a feedback signal: Input 90° phase difference signals (1x, 2x, 4x) on the EA/EB terminals, input two sets of positive and negative pulses.

If both EA and EB signals change at the same time, the LSI will treat this as an error and output an $\overline{\text{INT}}$ signal.

[Setting example]

RENV4 = 00360000h: Satisfy the conditions of Comparator 3 < COUNTER3 (deflection)
Stop immediately when the conditions are satisfied.

RCMP3 = 32: The maximum deflection value is "32" pulses.

RIRQ = 00000400h: Output an $\overline{\text{INT}}$ signal when the conditions for Comparator 3 are satisfied.

Specify the EA/EB input <Set EIM0 to 1 (bits 20 & 21) in RENV2> 00: 90° phase difference, 1x 01: 90° phase difference, 2x 10: 90° phase difference, 4x 11: 2-pulse mode	[RENV2] (WRITE) 23 16 - - n n 0 0 - -
Specify the EA/EB input count direction <Set EDIR (bit 22) in RENV2> 0: When the EA phase is leading, or count up on the EA rising edge. 1: When the EB phase is leading, or count up on the EB rising edge	[RENV2] (WRITE) 23 8 - n - - 0 0 - -
Read the EA/EB input error <ESEE (bit 16) in REST> 1: An EA/EB input error has occurred.	[REST] (READ) 23 16 0 0 0 0 0 0 - n
Counter reset command <CUN3R: Control command> Clear COUNTER3 (deflection) to zero.	[Control command] 22h

11-11-4. IDX (synchronous) signal output function

Using Comparator 4 and COUNTER4, the PCL can output signals to the P6n/CP4n terminals at specified intervals. Setting C4C0 and C4C1 to "11" (in the general-purpose counter) and setting C4S0 thru C4S3 to "1000", "1001" or "1010" (the IDX output), the PCL can be used for IDX (index) operation. The counter range of COUNTER4 will be 0 to the value set in RCMP4. If counting down from 0 the lower limit will be the value set in RCMP4, and if counting up from the value set in RCMP4 the limit will be 0. The input for COUNTER4 can be set to C140 or C141 in RENV3.

By setting IDXM in RENV4, you can select either level output or count output.

Select the specification for the P6/CP4 terminals <Set P6M0 to 1 in RENV2 (bits 12 and 13)> 10: Output an IDX signal using negative logic 11: Output an IDX signal using positive logic	[RENV2] (WRITE) 15 8 - - n n - - - -
Select the count input for COUNTER4 (general-purpose) <set to C140 and C41 (bits 12 & 13) in RENV3> 00: Output pulses 10: PA/PB input 01: EA/EB input 11: Divide the CLK input by 2.	[RENV3] (WRITE) 15 8 - - n n - - - -
Select the comparison counter for Comparator 4 <set C4C0 and 41 (bits 25 & 26) in RENV4> 11: COUNTER4 (general-purpose).	[RENV4] (WRITE) 31 24 - - - - - n n
Select the comparison method for COUNTER4 <set C4S0 to CSS3 (bits 26 to 29) in RENV4> 1000: IDX output (regardless of count direction) 1001: IDX output (only while counting up) 1010: IDX output (only while counting down)	[RENV4] (WRITE) 31 24 - - n n n n - -
Select the IDX output mode <set IDXM (bit 23) in RENV4> 0: Outputs an IDX signal while COUNTER4 = RCMP4. 1: Outputs an IDX signal for two CLK cycles when COUNTER4 reaches 0 by counting.	[RENV4] (WRITE) 23 16 n - - - - -

Note: While IDXM = 1, writing a "0" to COUNTER4 or resetting COUNTER4 will not output an IDX signal. The setting in IDXM is only effective when C4S0 to C4S3 are set to 1000, 1001, or 1010 (synchronous signal output).

Output example 1: IDXM = 0: Level output

Regardless of the feed direction, the PCL will output the IDX signal using negative logic for the output pulses. (Counting range: 0 to 4.)

Settings: RENV2 = D00002000h, RENV3 = 00000000h, RENV4 = 23000000h, RCMP4 = 4

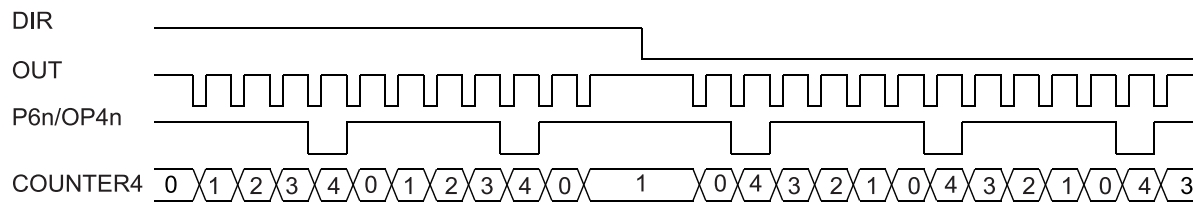

Output example 2 (IDXM = 1: Count output)

Regardless of the feed direction, the PCL will output the IDX signal using negative logic for the output pulses. Counting range 0 to 4.

Settings: RENV2 = 00002000h, RENV3 = 00000000h, RENV4 = 23800000h, RCMP4 = 4

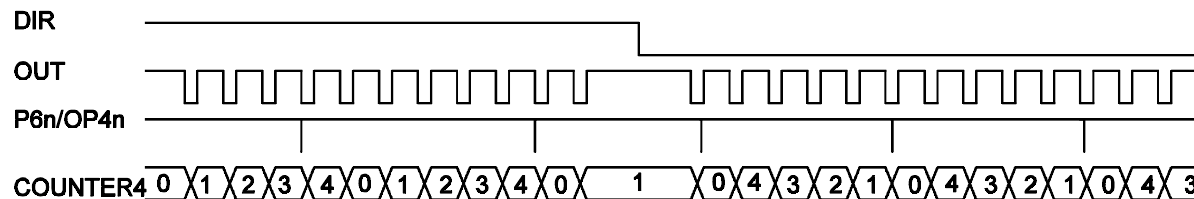

11-11-5. Ring count function

COUNTER1 and 2 have a ring count function for use in controlling a rotating table.

Set C1PM = 1, C1S0 to 2 = 000, and C1C0 to 1 = 00 in RENV4 and COUNTER1 will be in the ring count mode. Then the PCL can perform the following operations.

- Count value = Count up from the value in PCMP1 until reaching 0.
- Count value = Count down from 0 until the count equals the value in PCMP1.

Set C2PM = 1, C2S0 to 2 = 000, and C2C0 to 1 = 01 in RENV4 and COUNTER2 will be in the ring count mode. Then the PCL can perform the following operations.

- Count value = Count up from the value in PCMP2 until reaching 0.
- Count value = Count down from 0 until the count equals the value in RCMP2.

<p>Set COUNTER1 to ring counter operation <set C1RM, C1D0 to 1, C1S0 to 2, and C1C0 to 1 in RENV4> 10000000: Operate COUNTER1 as a ring counter.</p>	<p>[RENV2] (WRITE) 7 0 n n n n n n n n</p>
<p>Set COUNTER2 to ring count operation <set C2RM, C2D0 to 1, C2C0 to 1 in RENV4> 10000001: Operate COUNTER2 as a ring counter.</p>	<p>[RENV2] (WRITE) 15 8 n n n n n n n n</p>

Even if the value for PRMV outside the range of 0 to the value in RCMPn, the PCL will continue to perform positioning operations.

When driving a rotating table with 3600 pulses per revolution, and when RCMP1 = 3599, MOD = 41h, and RMV = 7200, the table will rotate twice and the value in COUNTER1, when stopped, will be the same as the value before starting.

Note: To use the ring counter function, set the count value between 0 and the value in RCMPn. If the value is outside the range above, the PCL will not operate normally. Set the comparator conditions (C1S0 to 2, C2S0 to 2) when using a counter as a ring counter to "000."

Setting example

RENV4 = XXXXXX80h --- COUNTER1 is in ring counter mode (C1RM = 1, C1S0 to 2 = 000, C1C0 to 1 = 00)
RCMP1 = 4 --- Count range: 0 to 4

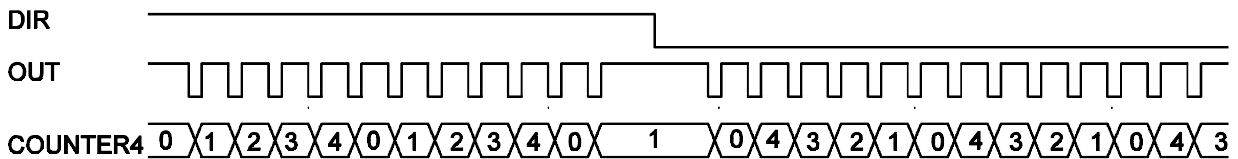

11-12. Backlash correction and slip correction

This LSI has backlash and slip correction functions. These functions output the number of command pulses specified for the correction value in the speed setting in the RFA (correction speed) register. The backlash correction is performed each time the direction of operation changes. The slip correction function is performed before a command, regardless of the feed direction. The correction amount and method is specified in the RENV6 (environment setting 6) register.

The operation of the counter (COUNTER 1 to 4) can be set using the RENV3 (environment setting 3) register.

Enter the correction value <BR0 to 11 (bits 0 to 11) in RENV6> Backlash or slip correction amount value (0 to 4095)	[RENV6] (WRITE) 15 8 - - - - n n n n 7 0 n n n n n n n n
Set the correction method <ADJ0 to 1 (bits 12 & 13) in RENV6> 00: Turn the correction function OFF 01: Backlash correction 10: Slip correction	[RENV6] (WRITE) 15 8 - - n n - - - -
Action for backlash/slip correction <CU1B to 4B (bit 24 to 27) in RENV3> CU1B (bit 16) = 1: Enable COUNTER1 (command position) CU2B (bit 17) = 1: Enable COUNTER2 (mechanical position) CU3B (bit 18) = 1: Enable COUNTER3 (deflection) CU4B (bit 19) = 1: Enable COUNTER4 (general-purpose)	[RENV3] (WRITE) 31 24 - - - - 0 n n n

11-13. Vibration restriction function

This LSI has a function to restrict vibration when stopping by adding one pulse of reverse operation and one pulse of forward operation shortly after completing a command pulse operation.

Specify the output timing for additional pulses in the RENV7 (environment setting 7) register.

When both the reverse timing (RT) and the forward timing (FT) are non zero, the vibration restriction function is enabled.

The dotted lines below are pulses added by the vibration restriction function. (An example in the positive direction)

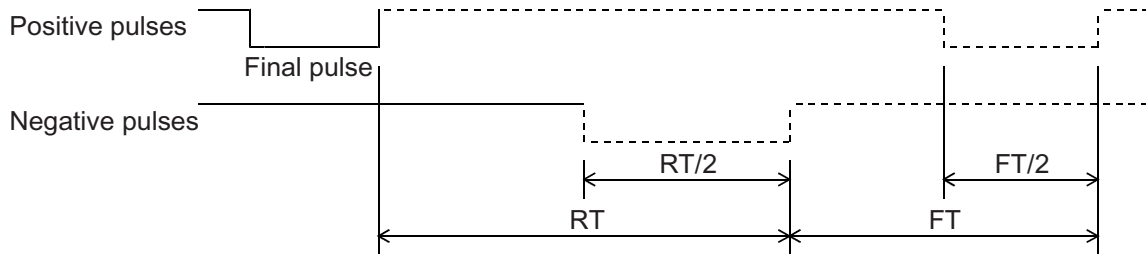

<p>Specify the reverse operation timing <Set RT0 to 15 (bits 0 to 15) in RENV7> RT range: 0 to 65,535 The units are 32x the reference clock frequency (approx. 1.6 μsec when CLK = 19,6608 MHz) Settable range: 0 to approx. 0.1 sec.</p>	<p>[RENV7] (WRITE) 15 8 n n n n n n n n 7 0 n n n n n n n n</p>
<p>Specify the forward operation timing <Set FT0 to 15 (bits 16 to 31) in RENV7> FT range: 0 to 65,535 The units are 32x the reference clock frequency (approx. 1.6 μsec when CLK = 19,6608 MHz) Settable range: 0 to approx. 0.1 sec.</p>	<p>[RENV7] (WRITE) 31 24 n n n n n n n n 23 16 n n n n n n n n</p>

Note: The optimum values for RT and FT will vary with each piece of machinery and load. Therefore, it is best to obtain these values by experiment.

11-14. Synchronous starting

This LSI can perform the following operation by setting the PRMD (operation mode) register in advance.

- ◆ Start triggered by another axis stopping.
- ◆ Start triggered by an internal synchronous signal from another axis.

The internal synchronous signal output is available with 9 types of timing. They can be selected by setting the RENV5 (environment setting 5) register. By setting the RIRQ (event interrupt cause) register, an $\overline{\text{INT}}$ signal can be output at the same time the internal synchronous signal is output. You can determine the cause of event interrupt by reading the RIST register. The operation status can be checked by reading the RSTS (extension status) register.

Specify the synchronous starting method <Set MSY0 to 1 (bits 18 & 19) in PRMD> 10: Start with an internal synchronous signal. 11: Start triggered by another axis stopping.	[RMD] (WRITE) 23 16 - - - - n n - -
Select an axis for confirming a stop (setting example) <Specify the axis using MAX0 to MAX3 (bits 20 to 23) in PRMD> 0001: Start when the X axis stops 0010: Start when the Y axis stops 0100: Start when the Z axis stops 1000: Start when the U axis stops 0011: Start when both the X and Y axes have stopped 0101: Start when both the X and Z axes have stopped 1011: Start when the X, Y, and U axes have all stopped 1111: Start when all of the axes have stopped	[RMD] (WRITE) 23 16 n n n n - - - -
Select the synchronous starting mode <Set SMAX (bit 29) in RENV2> 0: PCL6045 compatible mode 1: PCL6045B mode	[RENV2] (WRITE) 31 24 - - n - - - - -
Specify the internal synchronous signal output timing <Set SYO1 to 3 (bits 16 to 19) in RENV5> 0001: When the Comparator 1 conditions are satisfied. 0010: When the Comparator 2 conditions are satisfied. 0011: When the Comparator 3 conditions are satisfied. 0100: When the Comparator 4 conditions are satisfied. 0101: When the Comparator 5 conditions are satisfied. 1000: When the acceleration is started. 1001: When the acceleration is complete. 1010: When the deceleration is started. 1011: When the acceleration is complete Others: Internal synchronous output signal is OFF.	[RENV5] (WRITE) 23 16 - - - - n n n n
Specify the input for the internal synchronous signal <Set SYI0 to 1 (bits 20 & 21) in RENV5> 00: Use an internal synchronous signal output by the X axis. 01: Use an internal synchronous signal output by the Y axis. 10: Use an internal synchronous signal output on the Z axis. 11: Use an internal synchronous signal output on the U axis.	[RENV5] (WRITE) 23 16 - - n n - - - -
Read the operation status <CND (bits 0 to 3) in RSTS> 0011: Wait for an internal synchronous signal. 0100: Wait for another axis to stop.	[RSTS] (READ) 7 0 - - - - n n n n
Select the event interrupt ($\overline{\text{INT}}$ output) cause <Set bit 4 to 12 of RIRQ> IRUS (bit 4) = 1: When the acceleration is started. IRUE (bit 5) = 1: When the acceleration is complete. IRUS (bit 6) = 1: When the acceleration is started. IRUS (bit 7) = 1: When the deceleration is complete. IRC1 (bit 8) = 1: When the Comparator 1 conditions are satisfied. IRC2 (bit 9) = 1: When the Comparator 2 conditions are satisfied. IRC3 (bit 10) = 1: When the Comparator 3 conditions are satisfied. IRC4 (bit 11) = 1: When the Comparator 4 conditions are satisfied. IRC5 (bit 12) = 1: When the Comparator 5 conditions are satisfied.	[RIRQ] (WRITE) 7 0 n n n n - - - - 15 8 - - - - n n n n n n

Read the event interrupt (INT output) cause <Bit 4 to 12 of RIST>	[RIST] (READ)
IRUS (bit 4) 0: When the acceleration is started.	7 0
IRUS (bit 5) 0: When the acceleration is complete.	0 0 0 0 0 0 0 0
IRUS (bit 6) 0: When the deceleration is started.	15 8
IRUS (bit 7) 0: When the deceleration is complete.	0 0 0 0 0 0 0 0
IRC1 (bit 8) 0: When the Comparator 1 conditions are satisfied.	
IRC2 (bit 9) 0: When the Comparator 2 conditions are satisfied.	
IRC3 (bit 10) 0: When the Comparator 3 conditions are satisfied.	
IRC4 (bit 11) 0: When the Comparator 4 conditions are satisfied.	
IRC5 (bit 12) 0: When the Comparator 5 conditions are satisfied.	

11-14-1. Start triggered by another axis stopping

If the start condition is specified as a "Stop on two or more axes", when any of the specified axes stops after operating, and the other axes never start (remain stopped), the axis which is supposed to start when the conditions are met will start operation.

Example 1 below shows how to specify a "stop on two or more axes". In the example, while the X axis (or Y axis) is working, the Y (or X) axis remains stopped. Then, the U axis starts operation when triggered by the X (or Y) axis stopping.

[Example 1]

After setting steps 1) to 3), start and stop the Y axis and then the X axis will start.

- 1) Set MSY0 to 1 (bits 18 to 19) in PRMD for the U axis to "11." (Start triggered by another axis stopping)
- 2) Set MAX0 to 1 (bits 20 to 23) in PRMD for the U axis to "0011." (When the Y axis and then the X axis stops)
- 3) Write a start command for the U axis.

The "start when another axis stops" function has two operation modes: one is PCL6045 compatible and the other is the PCL6045B mode. Select the operation mode using SMAX in the RENV2 register. (When SMAX = 0, the PCL6045 compatible mode is selected.)

[PCL6045 compatible mode]

In order to use "Another axis stops" as a start condition, the axis specifying this condition (X axis) must be ready to start its process and then it can wait for the other axis to stop. At this point the other axis (the Y axis) can be started and stopped.

For example, if the X and Y axes are performing circular interpolation, and if "All Y axes stop" is set as a start condition in the pre-register for the next operation, when X and Y are "waiting for all axes to stop" (so that they can start the linear interpolation at the end of the circular interpolation), since they are already stopped the change "from operation to stop" will not occur while they are waiting. Therefore the X and Y axes will never start the linear interpolation.

In other words, the working axis cannot be specified for the MAX setting to start itself.

[PCL6045B mode]

When "start when another axis stops" is specified as the start condition for the next operation in a specific pre-register, the working axis can be called out in the MAX setting so that it starts itself on the next operation at the end of a previous operation.

Example 1

Settings

Operation mode for the X axis in initial operation: MSY0 to 1 = 00, MAX0 to 3 = 0000

Operation mode calling for the X axis in the next operation: MSY0 to 1 = 11, MAX0 to 3 = 0011

Operation mode for the Y axis in initial operation: MSY0 to 1 = 00, MAX0 to 3 = 0000

Operation mode calling for the Y axis in the next operation: MSY0 to 1 = 11, MAX0 to 3 = 0011

(X axis positioning operation time) > (Y axis positioning operation time)

1) When the PCL6045 compatible mode (SMAX=0) is selected

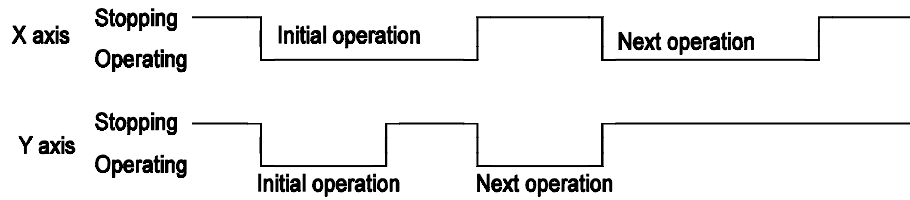

2) When the PCL6045B mode (SMAX=1) is selected

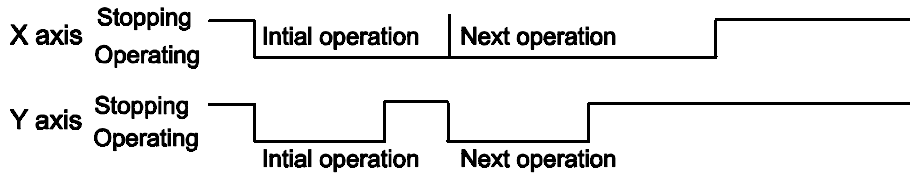

When using continuous interpolation without changing the interpolation axes, you may set the next operation in the pre-register (you don't need to specify any stop conditions) rather using the "start when another axis stops" function. The settings are shown in Example 2 below.

The example below describes only the items related to the operations. The settings for speed and acceleration are omitted.

[Setting example 2]

How to set up a continuous interpolation (X-Y axis circular interpolation followed by an X-Y axis linear interpolation)

Step	Register	X axis	Y axis	Description
1	PRMV	10000	10000	X and Y axes perform a circular interpolation operation of a 90° curve with a radius of 10000
	PRIP	10000	0	
	PRMD	0000_0064h	0000_0064h	
	Start command: Write 0351h (FH low speed start)			
2	PRMV	10000	5000	X and Y axes perform a linear interpolation with an endpoint (1000, 5000)
	PRMD	0000_0061h	0000_0061h	
	Start command: Write 0351h (FH low speed start)			

After the settings above are complete, the DSI will execute a continuous operation in the order shown below.

1. The X and Y axes perform a CW circular interpolation operation of a 90° curve with a radius of 10000.
2. The X and Y axes perform a linear interpolation (10000, 5000)

Precautions are needed for continuous interpolation operations that change the axes subject to interpolation using the pre-register function.

Basically, to change the axes subject to interpolation, enter dummy operation data for all the axes (positioning operations with the feed amount set to 0), and then write the interpolation data for the new axes subject to interpolation.

Note

When changing the interpolation axis, failure to enter dummy operation data for all the axes may cause a continuous operation to stop or the interpolation operation may not stop when desired.

[Example 3 (PCL6045 compatible mode)]

How to perform continuous interpolation while changing the interpolation axes (moving from circular interpolation on the X and Y axes) to (Linear interpolation on the X and Y axes) to (Linear interpolation on the X and Z axes)

STEP	Register	X axis	Y axis	Z axis	Details
1	PRMV	10000	10000	0	The X and Y axes make a 90° circular interpolation with a radius of 100000.
	PRIP	10000	0	0	The Z axis is given a positioning operation with feed amount of 0.
	PRMD	0000 _0064h	0000 _0064h	003C _0041h	The X and Y axes start immediately. The Z axis has nothing to do and waits for the X and Y axes to stop.
	Start command: Write 0751h (FH constant speed start)				The X, Y, and Z axes Start command
2	PRMV	10000	5000	0	The X and Y axes perform linear interpolation 1, and the Z axis is given a positioning operation with a feed amount of 0.
	PRMD	004C _0061h	004C _0061h	003C _0041h	The X and Y axes wait for the Z axis to stop, and the Z axis waits for the X and Y axes to stop.
	Start command: Write 0751h (FH constant start)				The X, Y, and Z axes Start command
3	PRMV	10000	(Previous value)	-5000	X and Z axes perform linear interpolation 1. The X and Y axes wait for the Z axis to stop and the Z axis starts again, just like in continuous operation.
	PRMD	004C _0061h	(Previous value)	0000 _0061h	
	Start command: Write 0551h (FH constant start)				The X and Z axes Start command (X, Z axes SPRF = 1).

Using the settings above, the PCL will perform steps 1 to 5 continuously.

1. Start a CW circular interpolation using a 90° angle and a radius 10000 on the X and Y axes.
2. After the X and Y axes stop, the Z axis positioning operation is complete (because the feed amount is 0).
3. Linear interpolation is performed on the X and Y axes (10000, 5000)
4. After the X and Y axes stop, the Z axis positioning operation is complete (because the feed amount is 0).
5. Linear interpolation is performed on the X and Z axes (10000, -5000).

Note: In STEP3 above, the value for the Y axis is left the same as in the previous step (STEP2), in order not to start the Y axis.

[Example 4 (PCL6045B mode)]

How to perform continuous interpolation while changing the interpolation axes (moving from circular interpolation on the X and Y axes) to (Linear interpolation on the X and Y axes) to (Linear interpolation on the X and Z axes)

STEP	Register	X axis	Y axis	Z axis	Details
1	PRMV	10000	10000	0	The X and Y axes perform a 90° circular interpolation with a radius of 10000. The Z axis is given a positioning operation with a feed amount of 0. The X, Y, and Z axes start.
	PRIP	10000	0	0	
	PRMD	0000 _0064h	0000 _0064h	0000 _0041h	
	Start command: Write 0751h (FH constant speed start)				
2	PRMV	10000	5000	0	The X and Y axes perform linear interpolation. The Z axis is given a positioning operation with a feed amount of 0. The X, Y, and Z axes wait for the X, Y, and Z axes to stop.
	PRMD	007C _0061h	007C _0061h	007C _0041h	
	Start command: Write 0751h (FH constant start)				
3	PRMV	0	0	0	Since the axes subject to interpolation are changed, all of the axes are given a dummy operation. The X, Y, and Z axes wait for the X, Y, and Z axes to stop
	PRMD	007C _0041h	007C _0041h	007C _0041h	
	Start command: Write 0751h (FH constant start)				
4	PRMV	10000	0	-5000	The X and Z axes perform linear interpolation. The Y axis is given a positioning operation with a feed amount of 0. The X, Y, and Z axes wait for the X, Y, and Z axes to stop
	PRMD	007C _0061h	007C _0041h	007C _0061h	
	Start command: Write 0751h (FH constant start)				

Using the settings above, the PCL will perform steps 1 to 3 continuously. (Specify STEP4 after STEP1 is complete)

1. Start a CW circular interpolation of 90° with a radius of 10000 on the X and Y axes. The Z axis performs a positioning operation with a feed amount of 0.
2. The X and Y axes perform a linear interpolation operation (10000, 5000). The Z axis performs a positioning operation with a feed amount of 0.
3. The X and Z axes perform a linear interpolation operation (10000, -5000). The Y axis performs a positioning operation with a feed amount of 0.

11-14-2. Starting from an internal synchronous signal

There are 9 types of internal synchronous signal output timing. They can be selected by setting the RENV5 register.

The monitor signal for the internal synchronous signal can be output externally.

Example 1 below shows how to use the end of an acceleration for the internal synchronous signal.

[Setting example 1]

After completing steps 1) to 3) below, write a start command to the X and Y axes, the X axis will start when the Y axis completes its acceleration.

- 1) Set MSY0 to 1 (bits 18 & 19) in the X axis RMD to 10. (Start with an internal synchronous signal)
- 2) Set SYI0 to 1 (bits 20 & 21) in the X axis to 01. (Use an

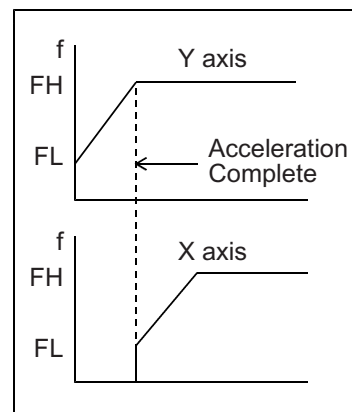

- internal synchronous signal from the Y axis.)
- Set SYO0 to 3 (bits 16 to 19) in the Y axis RENV5 to 1001. (Output an internal synchronous signal when the acceleration is complete)

Example 2 shows how to start another axis using the satisfaction of the comparator conditions to generate an internal synchronous signal.

Be careful, since comparator conditions satisfied by timing and the timing of the start of another axis may be different according to the comparison method used by the comparators.

[Example 2]

Use COUNTER1 (command position) and Comparator 1 to start the X axis when the Y axis = 1000.

- Set MSY0 to 1 (bits 18 & 19) in the Y axis RMD to 10. (Start from an internal synchronous signal)
- Set SYI0 to 1 (bits 20 & 21) in the X axis RENV5 to 01. (Use an internal synchronous signal from the Y axis)
- Set SYO0 to 3 (bits 16 to 19) in the Y axis RENV5 to 0001. (Output an internal synchronous signal when the Comparator 1 conditions are satisfied)
- Set C1C0 to 1 (bits 0 & 1) in the Y axis RENV4 to 00. (Comparator 1 comparison counter is COUNTER1)
- Set C1S0 to 2 (bits 2 to 4) in the Y axis RENV4 to 001. (Comparison method: Comparator 1 = Comparison counter)
- Set C1D0 to 1 (bits 5 & 6) in the Y axis RENV4 to 00. (Do nothing when the Comparator 1 condition are satisfied)
- Set the RCMP1 value of the Y axis to 1000. (Comparison counter value of Comparator 1 is 1000.)
- Write start commands for the X and Y axes.

The timing chart below shows the period after the Comparator 1 conditions are established and the X axis starts.

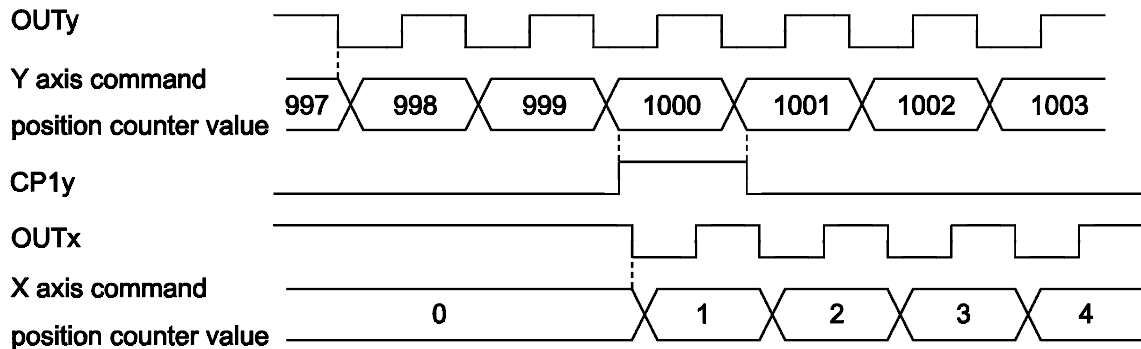

Note: In the example above, even if the Y feed amount is set to 2000 and the X feed amount is set to 1000, the X axis will be 1 when the Y axis position equals 1000. Therefore, the operation complete position will be one pulse off for both the X and Y axes. In order to make the operation complete timing the same, set the RCMP1 value to 1001 or set the comparison conditions to "Comparator 1 < comparison counter."

Specify the use of the P0/FUP terminal <Set P0M0 to 1 (bits 0 & 1) in RENV2> 10: Output an FUP (accelerating) signal	[RENV2] (WRITE) 7 0 - - - - - n n
Specify the use of the P1/FDW terminal <Set P1M0 to 1 (bits 2 & 3) in RENV2> 10: Output an FDW (decelerating) signal	[RENV2] (WRITE) 7 0 - - - - - n n - -
Select the output logic for P0 (one shot) / FUP <Set P0L (bit 16) in RENV2> 0: Negative logic 1: Positive logic	[RENV2] (WRITE) 23 16 - - - - - 0 0 - -

Select the output logic for P1 (one shot) / FDW <Set P1L (bit 17) in RENV2> 0: Negative logic 1: Positive logic	[RENV2] (WRITE) 23 16 - - - - 0 0 n -
Specify the use of the P3/CP1 (+SL) terminal <Set P3M0 to 1 (bits 6 & 7) in RENV2> 10: Output CP1 (Comparator 1 conditions are satisfied) using negative logic. 11: Output CP1 (Comparator 1 conditions are satisfied) using positive logic.	[RENV2] (WRITE) 7 0 n n - - - - - -
Specify the use of the P4/CP2 (-SL) terminal <Set P4M0 to 1 (bits 8 & 9) in RENV2> 10: Output CP2 (Comparator 2 conditions are satisfied) using negative logic. 11: Output CP2 (Comparator 2 conditions are satisfied) using positive logic.	[RENV2] (WRITE) 15 8 - - - - - - n n
Specify the use of the P5/CP3 terminal <Set P5M0 to 1 (bits 10 & 11) in RENV2> 10: Output CP3 (Comparator 3 conditions are satisfied) using negative logic. 11: Output CP3 (Comparator 3 conditions are satisfied) using positive logic.	[RENV2] (WRITE) 15 8 - - - - n n - -
Specify the use of the P6/CP4 terminal <Set P6M0 to 1 (bits 12 & 13) in RENV2> 10: Output CP4 (Comparator 4 conditions are satisfied) using negative logic. 11: Output CP4 (Comparator 4 conditions are satisfied) using positive logic.	[RENV2] (WRITE) 15 8 - - n n - - - -
Specify the use of the P7/CP5 terminal <Set P7M0 to 1 (bits 14 & 15) in RENV2> 10: Output CP5 (Comparator 5 conditions are satisfied) using negative logic. 11: Output CP5 (Comparator 5 conditions are satisfied) using positive logic.	[RENV2] (WRITE) 15 8 n n - - - - - -

11-15. Output an interrupt signal

This LSI can output an interrupt signal ($\overline{\text{INT}}$ signal) : There are 17 types of errors, 19 types of events, and change from operating to stop that can cause an $\overline{\text{INT}}$ signal to be output . All of the error causes will always output an $\overline{\text{INT}}$ signal. Each of the event causes can be set in the RIRQ register to output an $\overline{\text{INT}}$ signal or not.

A stop interrupt is a simple interrupt function which produces an interrupt separate from a normal stop or error stop.

For a normal stop interrupt to be issued, the confirmation process reads the RIST register as described in the Cause of an Event section. If your system needs to provide a stop interrupt whenever a stop occurs, it is easy to use the stop interrupt function.

To approximate a free curve interpolation using multiple linear interpolation operations, event interrupts will be generated at the end of each linear interpolation. When using the stop interrupt, set $\text{MENI} = 1$ in the RMD register. You can set it to not output an $\overline{\text{INT}}$ signal if there is data for the next operation.

The $\overline{\text{INT}}$ signal is output continuously until all the causes on all the axes that produced interrupts have been cleared. An interrupt caused by an error is cleared by writing a "REST (error cause) register read command." An interrupt caused by an event is cleared by writing a "RIST (event cause) register read command." A Stop interrupt is cleared by writing to the main status.

To determine which type of interrupt occurred, on which axis and the cause of the interrupt, follow the procedures below.

- 1) Read the main status of the X axis and check whether bits 2, 4, or 5 is "1."
- 2) If bit 2 (SENI) is "1," a Stop interrupt occurs.
- 3) If bit 4 (SERR) is "1," read the RESET register to identify the cause of the interrupt.
- 4) If bit 5 (SINT) is "1," read the RIST register to identify the cause of the interrupt.
- 5) Repeat steps 1) to 4) above for the Y, Z, and U axes.

The steps above will allow you to evaluate the cause of the interrupt and turn the $\overline{\text{INT}}$ output OFF.

Note 1: When reading a register from the interrupt routine, the details of the input/output buffer will change. If the $\overline{\text{INT}}$ signal is output while the main routine is reading or writing registers, and the interrupt routine starts, the main routine may produce an error. Therefore, the interrupt routine should execute a PUSH/POP on input/output buffer.

Note 2: While processing all axes in steps 1) to 4) above, it is possible that another interrupt may occur on an axis whose process has completed. In this case, if the CPU interrupts reception mode, and is set for edge triggering, the PCL will latch the $\overline{\text{INT}}$ output ON and it will not allow a new interrupt to interfere. Therefore, make sure that after you have reset the interrupt reception status the CPU reads main status of all the axes again. Also, make sure there is no $\overline{\text{INT}}$ signal output from the PCL. Then, end the interrupt routine.

Note 3: When not using the $\overline{\text{INT}}$ terminal, leave it open.
When using more than one PCL, the $\overline{\text{INT}}$ terminals cannot be wired ORed.

The $\overline{\text{INT}}$ signal output can be masked by setting the RENV1 (environment setting 1) register.

If the $\overline{\text{INT}}$ output is masked ($\text{INTM} = 1$ in RENV1), and when the interrupt conditions are satisfied, the status will change. However, the $\overline{\text{INT}}$ signal will not go LOW, but will remain HIGH.

While the interrupt conditions are satisfied and if the output mask is turned OFF ($\text{INTM} = 0$ in RENV1), the $\overline{\text{INT}}$ signal will go LOW.

Read the interrupt status <SENI(bit2), SERR (bit 4), SINT (bit 5) in MSTSW> SENI = 1: When IEND = 1 and a stop interrupt occurs, make this bit 1. After reading MSTS, it will become 0. SERR = 1: Becomes 1 when an error interrupt occurs. Becomes 0 by reading REST. SINT = 1: Becomes 1 when an event interrupt occurs. Becomes 0 by reading RIST.	[MSTSW] (READ) <div style="text-align: center;"> 7 0 </div> <div style="text-align: center;"> - - n n - - - - </div>
Set the interrupt mask <INTM (bit 29) in RENV1> 1: Mask INT output.	[RENV1] (WRITE) <div style="text-align: center;"> 31 24 </div> <div style="text-align: center;"> - - n - - - - </div>
Setting a stop interrupt <IEDN (bit 27) in RENV2> 1: Enable a stop interrupt.	[RENV2] (WRITE) <div style="text-align: center;"> 31 24 </div> <div style="text-align: center;"> - - - - n - - - </div>
Select the stop interrupt mode <MENI (bit 7) of PRMD> 1: When there is data for the next operation in the pre-register, the PCL will not output a stop interrupt.	[PRMD] (WRITE) <div style="text-align: center;"> 7 0 </div> <div style="text-align: center;"> n - - - - - </div>
Read the cause of the error interrupt <RREST: Read out command> Copy the data in the RESET register (error interrupt cause) to BUF.	[Read command] <div style="border: 1px solid black; padding: 2px; width: fit-content; margin: 0 auto;">F2h</div>
Read the event interrupt cause <RRIST: Read out command> Copy the data in the RIST register (event interrupt cause) to BUF.	[Read command] <div style="border: 1px solid black; padding: 2px; width: fit-content; margin: 0 auto;">F3h</div>
Set the event interrupt cause <WRIRQ: Write command> Write the BUF data to the RIRQ register (event interrupt cause).	[Write command] <div style="border: 1px solid black; padding: 2px; width: fit-content; margin: 0 auto;">ACh</div>

Operation example in which MENI is set

This is operation is used to write data for the next operation and the operation after that when starting.

1) When IEND = 1 and MENI = 0

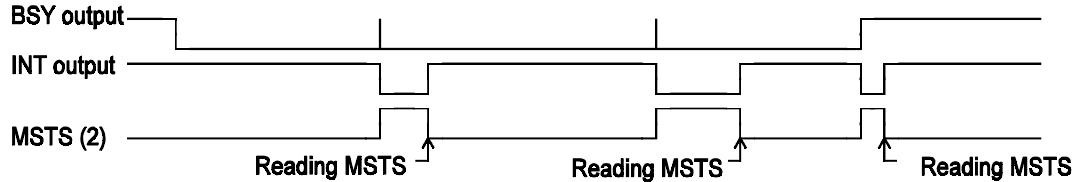

2) When IEND = 1 and MENI = 1

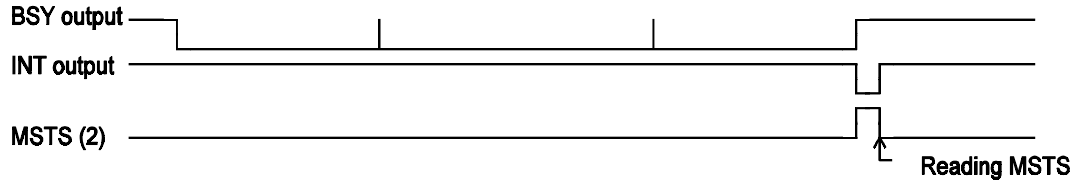

Note: Even if IEND = 1 and MENI = 1, if no pre-register has been specified (a Start command has not been written yet), the PCL will output an interrupt signal.

[Error interrupt causes] <Detail of REST: The cause of an interrupt makes the corresponding bit "1">

Error interrupt cause	Cause (REST)	
	Bit	Bit name
Stopped by Comparator 1 conditions being satisfied (+SL)	0	ESC1
Stopped by Comparator 2 conditions being satisfied (-SL)	1	ESC2
Stopped by Comparator 3 conditions being satisfied	2	ESC3
Stopped by Comparator 4 conditions being satisfied	3	ESC4
Stopped by Comparator 5 conditions being satisfied	4	ESC5
Stopped by turning ON the +EL input	5	ESPL
Stopped by turning ON the -EL input	6	ESML
Stopped by turning ON the ALM input	7	ESAL
Stopped by turning ON the $\overline{\text{CSTP}}$ input	8	ESSP
Stopped by turning ON the $\overline{\text{CEMG}}$ input	9	ESEM
Deceleration stopped by turning ON the SD input	10	ESSD
(Always 0)	11	Not defined
Stopped by an operation data error.	12	ESDT
Simultaneously stopped with another axis due to an error stop on the other axis during an interpolation operation	13	ESIP
Stopped by an overflow of PA/PB input buffer counter occurrence	14	ESPO
Stopped by an over range count occurrence while positioning in an interpolation operation	15	ESAO
An EA/EB input error occurred (does not stop).	16	ESEE
An PA/PB input error occurred (does not stop).	17	ESPE

[Event interrupt causes] < The corresponding interrupt bit is set to 1 and then an interrupt occurred>

Event interrupt cause	Set cause (RIRQ)		Cause (RIST)	
	Bit	Bit name	Bit	Bit name
Automatic stop	0	IREN	0	ISEN
The next operation starts continuously	1	IRNX	1	ISNX
When it is possible to write an operation to the 2nd pre-register	2	IRNM	2	ISNM
When it is possible to write to the 2nd pre-register for Comparator 5	3	IRND	3	ISND
When acceleration starts	4	IRUS	4	ISUS
When acceleration ends	5	IRUE	5	ISUE
When deceleration starts	6	IRDS	6	ISDS
When deceleration ends	7	IRDE	7	ISDE
When the Comparator 1 conditions are satisfied	8	IRC1	8	ISC1
When the Comparator 2 conditions are satisfied	9	IRC2	9	ISC2
When the Comparator 3 conditions are satisfied	10	IRC3	10	ISC3
When the Comparator 4 conditions are satisfied	11	IRC4	11	ISC4
When the Comparator 5 conditions are satisfied	12	IRC5	12	ISC5
When the counter value is reset by a CLR signal input	13	IRCL	13	ISCL
When the counter value is latched by an LTC input	14	IRLT	14	ISLT
When the counter value is latched by an ORG input	15	IROL	15	ISOL
When the SD input is turned ON	16	IRSD	16	ISSD
When the +DR input changes	17	IRDR	17	ISPD
When the -DR input changes			18	ISMD
When the $\overline{\text{CSTA}}$ input is turned ON	18	IRSA	19	ISSA

12. Electrical Characteristics

12-1. Absolute maximum ratings

Item	Symbol	Rating	Unit
Power supply voltage	V_{dd5}	-0.3 to +6.0	V
	V_{dd3}	-0.3 to +4.5	
Input voltage	V_{IN}	-0.3 to $V_{dd5} + 0.3$	V
Input current	I_{IN}	± 10	mA
Storage temperature	T_{stg}	-40 to +125	$^{\circ}\text{C}$

12-2. Recommended operating conditions

Item	Symbol	Rating	Unit
Power supply voltage	V_{dd5}	4.5 to 5.5	V
	V_{dd3}	3.0 to 3.6	
Ambient temperature	T_J	-40 to +70	$^{\circ}\text{C}$

12-3. DC characteristics

Item	Symbol	Condition	Min.	Max.	Unit
Current consumption	I_{dd5}	CLK = 20 MHz, Output frequency = 6.666667 MHz, No load		7	mA
	I_{dd3}			120	
Output leakage current	I_{OZ}		-10	10	μ A
Input capacitance				5.6	pF
LOW input current	I_{IL}	Input and input/output terminals, other than CLK.	-200	10	μ A
		CLK terminal	-10	10	μ A
HIGH input current	I_{IH}		-10	10	μ A
LOW input current	V_{IL}	Inputs and input/output terminals, except CLK.		0.8	V
		CLK terminal		1.0	V
HIGH input current	V_{IH}	Inputs and input/output terminals, except CLK.	2.0		V
		CLK terminal	4.0		V
LOW output voltage	V_{OL}	$I_{OL} = 1 \mu$ A		0.05	V
		$I_{OL} = 8$ mA		0.4	V
HIGH output voltage	V_{OH}	$I_{OH} = -1 \mu$ A	$V_{dd5}-0.05$		V
		$I_{OH} = -8$ mA	2.4		V
LOW output current	I_{OL}	$V_{OL} = 0.4$ V		8	mA
HIGH output current	I_{OH}	$V_{OH} = 2.4$ V	-8		mA
Internal pull up resistance	R_{UP}		25	500	K-ohm

12-4. AC characteristics 1) (reference clock)

Item	Symbol	Condition	Min.	Max.	Unit
Reference clock frequency	f_{CLK}			20	MHz
Reference clock cycle	T_{CLK}		50		ns
Reference clock HIGH width	T_{CKH}		20		ns
Reference clock LOW width	T_{CKL}		20		ns

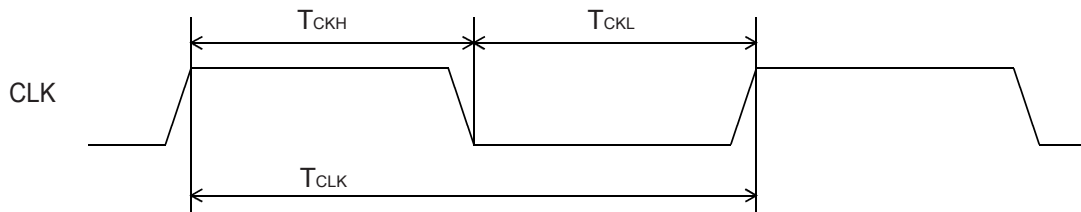

12-5. AC characteristics 2) (CPU I/F)

12-5-1. CPU-I/F 1) (IF1 = H, IF0 = H) Z80

Item	Symbol	Condition	Min.	Max.	Unit
Address setup time for $\overline{RD} \downarrow$	T_{AR}		29		ns
Address setup time for $\overline{WR} \downarrow$	T_{AW}		17		ns
Address hold time for $\overline{RD}, \overline{WR} \uparrow$	T_{RWA}		0		ns
\overline{CS} setup time for $\overline{RD} \downarrow$	T_{CSR}		20		ns
\overline{CS} setup time for $\overline{WR} \downarrow$	T_{CSW}		8		ns
\overline{CS} hold time for $\overline{RD}, \overline{WR} \uparrow$	T_{RWCS}		0		ns
\overline{WRQ} ON delay time for $\overline{CS} \downarrow$	T_{CSWT}	$C_L = 40\text{pF}$		25	ns
\overline{WRQ} signal LOW time	T_{WAIT}			$4T_{CLK}$	ns
Data output delay time for $\overline{RD} \downarrow$	T_{RDLD}	$C_L = 40\text{pF}$		25	ns
Data output delay time for $\overline{WRQ} \uparrow$	T_{WTHD}	$C_L = 40\text{pF}$		15	ns
Data float delay time for $\overline{RD} \uparrow$	T_{RDHD}	$C_L = 40\text{pF}$		12	ns
\overline{WR} signal width	T_{WR}	Note 1	10		ns
Data setup time for $\overline{WR} \uparrow$	T_{DWR}		14		ns
Data hold time for $\overline{WR} \uparrow$	T_{WRD}		0		ns

Note 1: When a \overline{WRQ} signal is output, the duration will be the interval between $\overline{WRQ} = \text{H}$ and $\overline{WR} = \text{H}$.

<Read cycle>

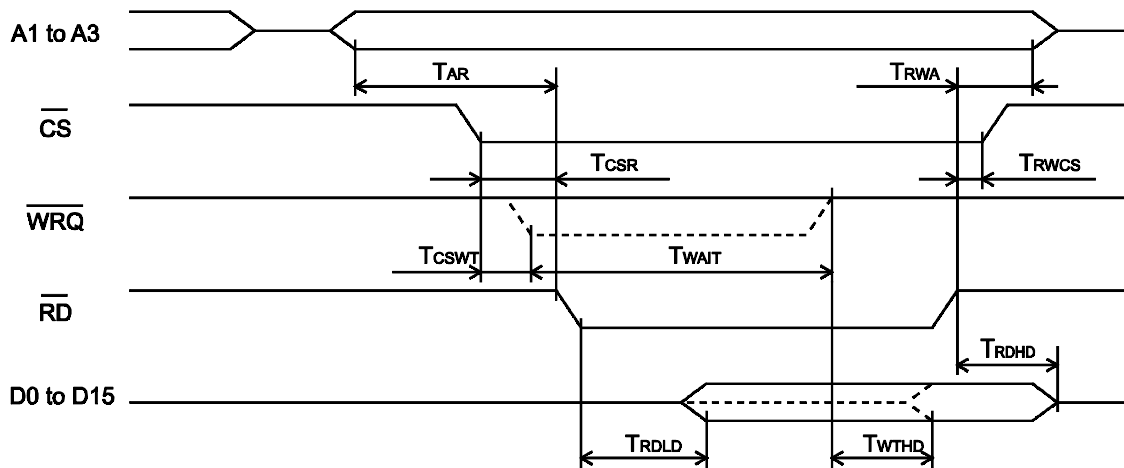

<Write cycle>

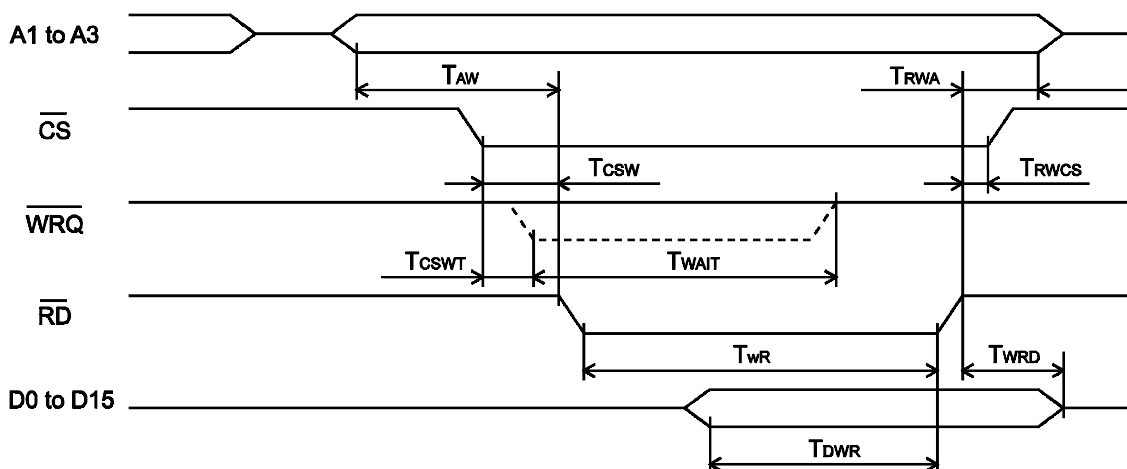

12-5-2. CPU-I/F 2) (IF1 = H, IF0 = L) 8086

Item	Symbol	Condition	Min.	Max.	Unit
Address setup time for $\overline{RD} \downarrow$	T_{AR}		28		ns
Address setup time for $\overline{WR} \downarrow$	T_{AW}		17		ns
Address hold time for $\overline{RD}, \overline{WR} \uparrow$	T_{RWA}		0		ns
\overline{CS} setup time for $\overline{RD} \downarrow$	T_{CSR}		19		ns
\overline{CS} setup time for $\overline{WR} \downarrow$	T_{CSW}		8		ns
\overline{CS} hold time for $\overline{RD}, \overline{WR} \uparrow$	T_{RWCS}		0		ns
\overline{WRQ} ON delay time for $\overline{CS} \downarrow$	T_{CSWT}	$C_L = 40pF$		25	ns
\overline{WRQ} signal LOW time	T_{WAIT}			$4T_{CLK}$	ns
Data output delay time for $\overline{RD} \downarrow$	T_{RDLD}	$C_L = 40pF$		30	ns
Data output delay time for $\overline{WRQ} \uparrow$	T_{WTHD}	$C_L = 40pF$		13	ns
Data float delay time for $\overline{RD} \uparrow$	T_{RDHD}	$C_L = 40pF$		16	ns
\overline{WR} signal width	T_{WR}	Note 1	10		ns
Data setup time for $\overline{WR} \downarrow$	T_{DWR}		14		ns
Data hold time for $\overline{WR} \uparrow$	T_{WRD}		0		ns

Note 1: When a \overline{WRQ} signal is output, the duration will be the interval between $\overline{WRQ} = H$ and $\overline{WR} = H$.

<Read cycle>

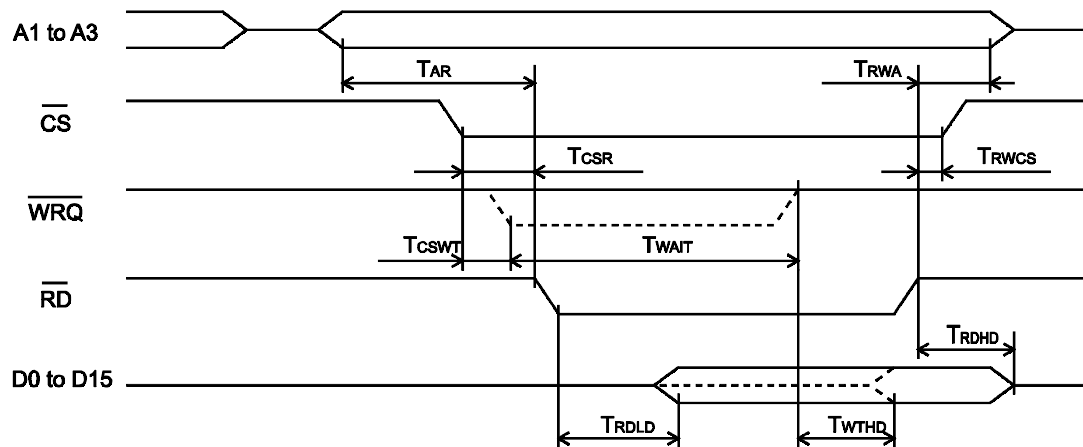

<Write cycle>

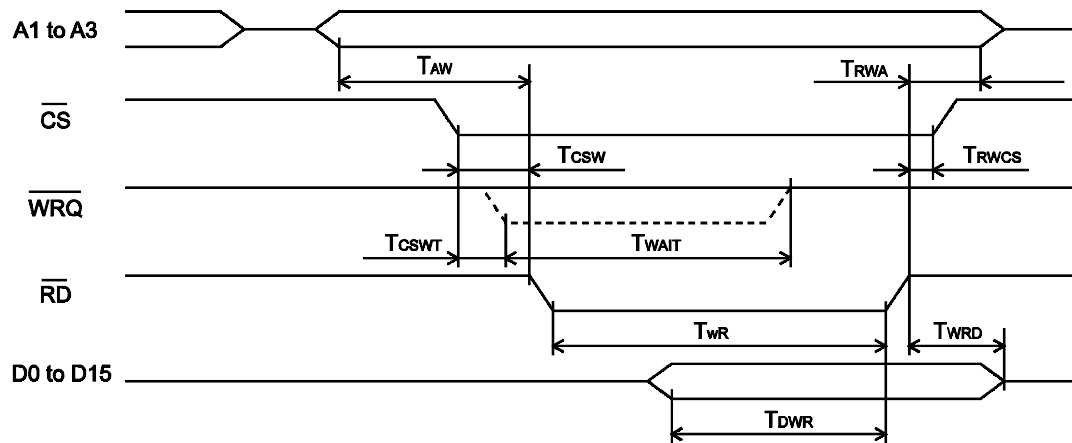

12-5-3. CPU-I/F 3) (IF1 = L, IF0 = L) H8

Item	Symbol	Condition	Min.	Max.	Unit
Address setup time for $\overline{RD} \downarrow$	T_{AR}		29		ns
Address setup time for $\overline{WR} \downarrow$	T_{AW}		13		ns
Address hold time for $\overline{RD}, \overline{WR} \uparrow$	T_{RWA}		0		ns
\overline{CS} setup time for $\overline{RD} \downarrow$	T_{CSR}		20		ns
\overline{CS} setup time for $\overline{WR} \downarrow$	T_{CSW}		9		ns
\overline{CS} hold time for $\overline{RD}, \overline{WR} \uparrow$	T_{RWCS}		0		ns
\overline{WRQ} ON delay time for $\overline{CS} \downarrow$	T_{CSWT}	$C_L = 40\text{pF}$		25	ns
\overline{WRQ} signal LOW time	T_{WAIT}			$4T_{CLK}$	ns
Data output delay time for $\overline{RD} \downarrow$	T_{RDLD}	$C_L = 40\text{pF}$		30	ns
Data output delay time for $\overline{WRQ} \uparrow$	T_{WTHD}	$C_L = 40\text{pF}$		13	ns
Data float delay time for $\overline{RD} \uparrow$	T_{RDHD}	$C_L = 40\text{pF}$		16	ns
\overline{WR} signal width	T_{WR}	Note 1	10		ns
Data setup time for $\overline{WR} \downarrow$	T_{DWR}		12		ns
Data hold time for $\overline{WR} \uparrow$	T_{WRD}		0		ns

Note 1: When a \overline{WRQ} signal is output, the duration will be the interval between $\overline{WRQ} = \text{H}$ and $\overline{WR} = \text{H}$.

<Read cycle>

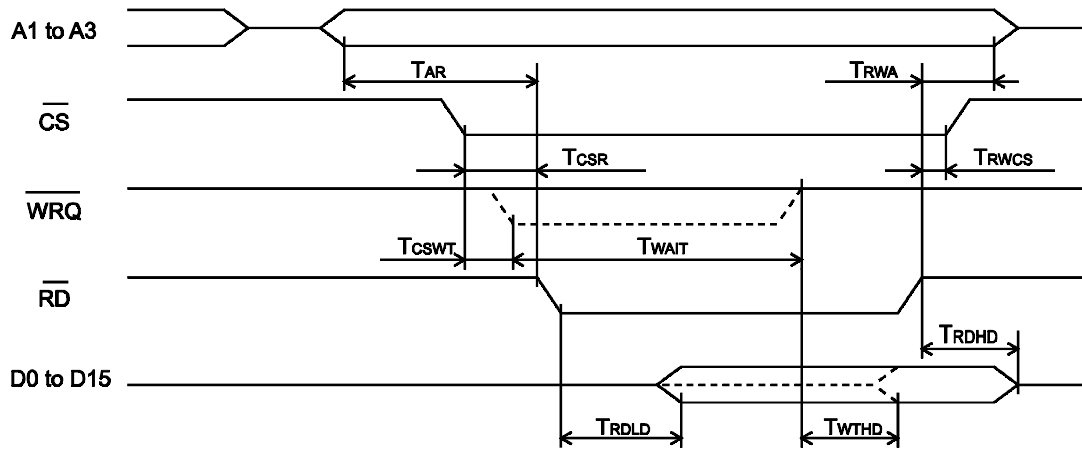

<Write cycle>

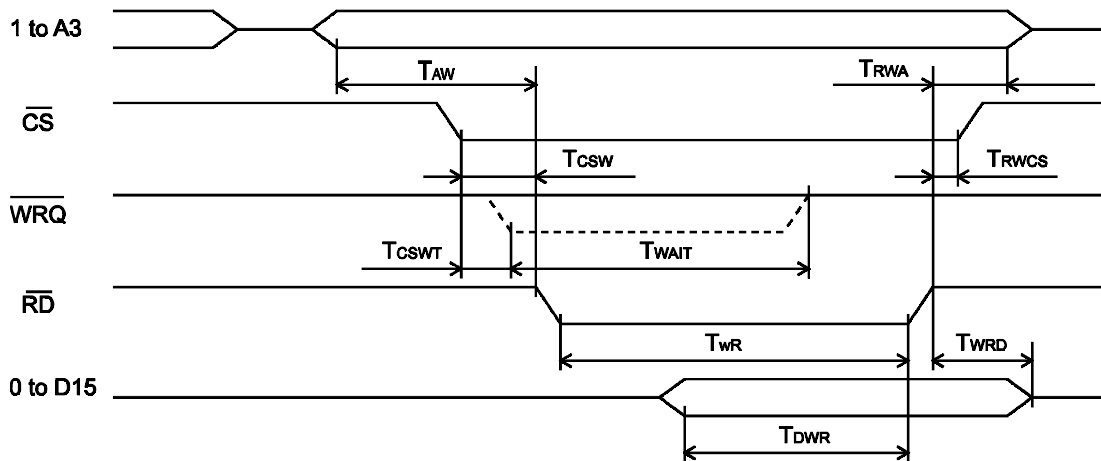

12-5-4. CPU-I/F 4) (IF1 = L, IF0 = L) 68000

Item	Symbol	Condition	Min.	Max.	Unit
Address setup time for \overline{CS} ↓	T_{AS}		19		ns
Address hold time for \overline{CS} ↑	T_{SA}		0		ns
CS setup time for \overline{CS} ↓	T_{CSS}		11		ns
CS hold time for \overline{CS} ↑	T_{SCS}		0		ns
R/ \overline{W} setup time for \overline{CS} ↓	T_{RWS}		3		ns
R/ \overline{W} hold time for \overline{CS} ↑	T_{SRW}		3		ns
\overline{ACK} ON delay time for \overline{CS} ↓	T_{SLAKR}	$C_L = 40pF$	$1T_{CLK}$	$4T_{CLK}+29$	ns
	T_{SLAKW}	$C_L = 40pF$	$1T_{CLK}$	$4T_{CLK}+29$	ns
\overline{ACK} OFF delay time for \overline{CS} ↑	T_{SHAKR}	$C_L = 40pF$		18	ns
	T_{SHAKW}	$C_L = 40pF$		18	ns
Data output advance time for \overline{ACK} ↓	T_{DAKLR}	$C_L = 40pF$	$1T_{CLK}$		ns
Data float delay time for \overline{CS} ↑	T_{SHD}	$C_L = 40pF$		16	ns
Data setup time for \overline{CS} ↑	T_{DSL}		13		ns
Data hold time for \overline{ACK} ↓	T_{AKDH}		0		ns

<Read cycle>

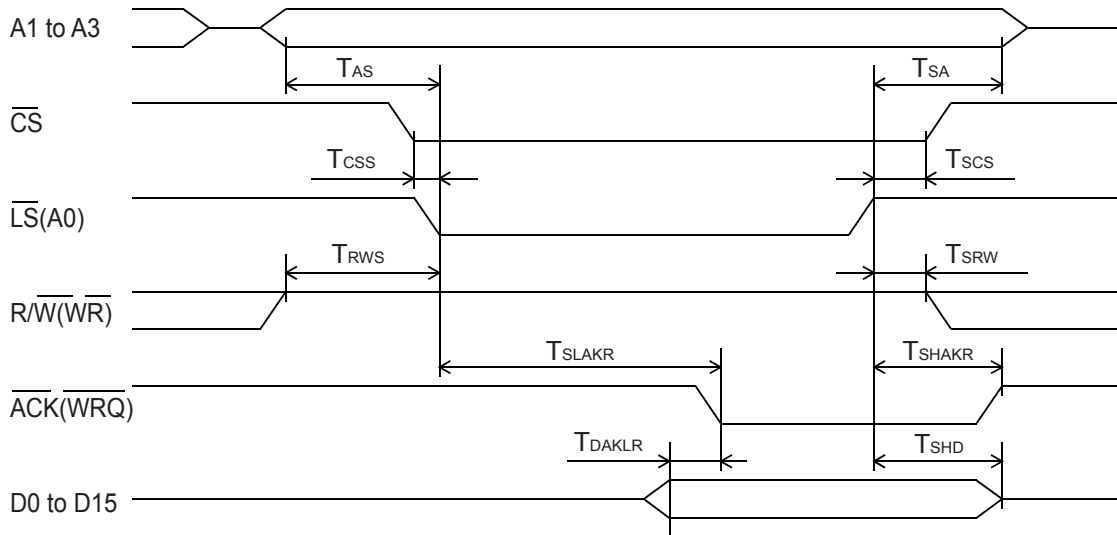

<Write cycle>

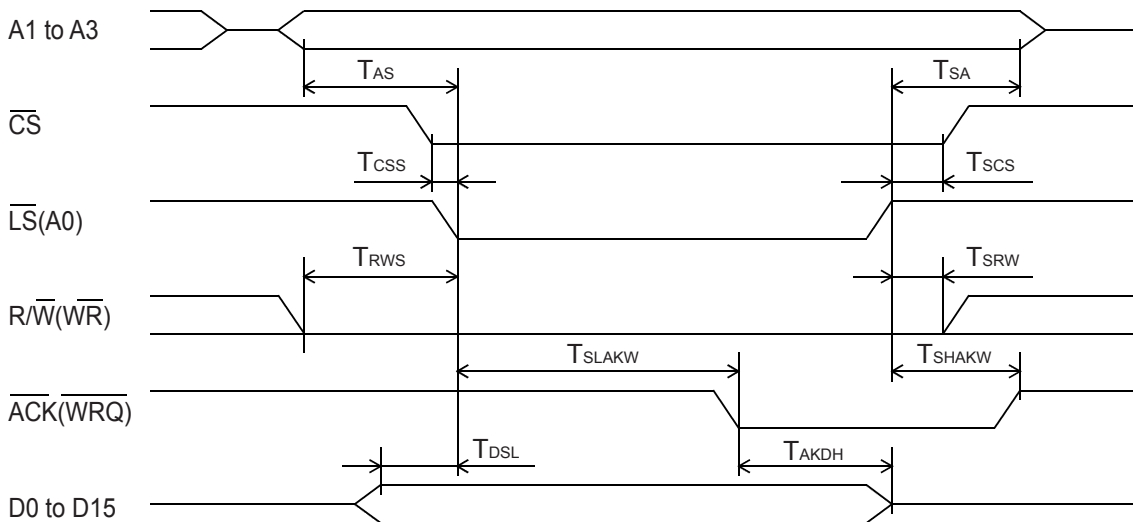

12-6. Operation timing

Item	Symbol	Condition	Min.	Max.	Unit
\overline{RST} input signal width		Note 1	$10T_{CLK}$		ns
CLR input signal width			$2T_{CLK}$		ns
EA, EB input signal width	T_{EAB}	Note 2	$1T_{CLK}$ ($3T_{CLK}$)		ns
EZ input signal width		Note 2	$1T_{CLK}$ ($3T_{CLK}$)		ns
PA, PB input signal width	T_{PAB}	Note 3	$1T_{CLK}$ ($3T_{CLK}$)		ns
ALM input signal width		Note 4	$2T_{CLK}$		ns
INP input signal width		Note 4	$2T_{CLK}$		ns
ERC output signal width		RENV1 bit 12 to 14 = 000	$254T_{CLK}$	$255T_{CLK}$	ns
		RENV1 bit 12 to 14 = 001	$254 \times 8T_{CLK}$	$255 \times 8T_{CLK}$	
		RENV1 bit 12 to 14 = 010	$254 \times 32T_{CLK}$	$255 \times 32T_{CLK}$	
		RENV1 bit 12 to 14 = 011	$254 \times 128T_{CLK}$	$255 \times 128T_{CLK}$	
		RENV1 bit 12 to 14 = 100	$254 \times 1024T_{CLK}$	$255 \times 1024T_{CLK}$	
		RENV1 bit 12 to 14 = 101	$254 \times 4096T_{CLK}$	$255 \times 4096T_{CLK}$	
		RENV1 bit 12 to 14 = 110	$254 \times 8192T_{CLK}$	$255 \times 8192T_{CLK}$	
		RENV1 bit 12 to 14 = 111	LEVEL output		
+EL, -EL input signal width		Note 4	$2T_{CLK}$		ns
SD input signal width		Note 4	$2T_{CLK}$		ns
ORG input signal width		Note 4	$2T_{CLK}$		ns
+DR, -DR input signal width		Note 5	$2T_{CLK}$		ns
\overline{PE} input signal width		Note 5	$2T_{CLK}$		ns
PCS input signal width			$2T_{CLK}$		ns
LTC input signal width			$2T_{CLK}$		ns
\overline{CSTA}	Output signal width		$8T_{CLK}$		ns
	Input signal width		$5T_{CLK}$		ns
\overline{CSTP}	Output signal width		$8T_{CLK}$		ns
	Input signal width		$5T_{CLK}$		ns
\overline{BSY} signal ON delay time	T_{CMDBSY}			$5T_{CLK}$	ns
	T_{STABSY}			$7T_{CLK}$	ns
Start delay time	T_{CMDPLS}			$15T_{CLK}$	ns
	T_{STAPLS}			$17T_{CLK}$	ns

Note 1: The actual CLK input signal is 10 cycles longer while the \overline{RST} terminal is LOW.

Note 2: If the input filter is ON < FLTR (bit 18) = 1 in RENV2 >, the minimum time will be $3T_{CLK}$.

Note 3: If the input filter is ON < DRF (bit 19) = 1 in RENV2 >, the minimum time will be $3T_{CLK}$.

Note 2: If the input filter is ON < FLTR (bit 26) = 1 in RENV1 >, the minimum time will be $80T_{CLK}$.

Note 3: If the input filter is ON < DRF (bit 27) = 1 in RENV1 >, the minimum time will be $655,360T_{CLK}$.

1) When the EA, EB inputs are in the 2-pulse mode

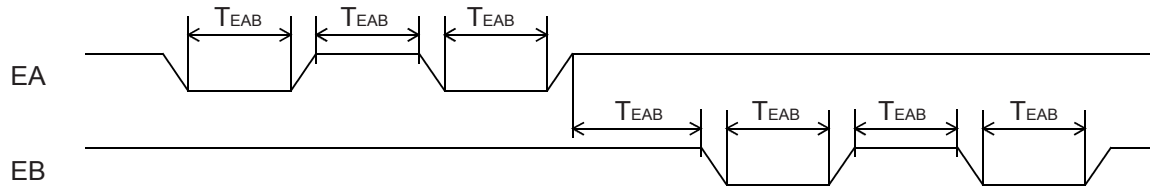

2) When the EA, EB inputs are in the 90° phase-difference mode

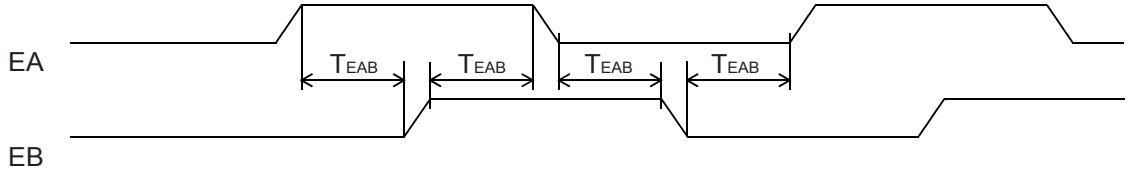

3) When the PA, PB inputs are in the 2-pulse mode

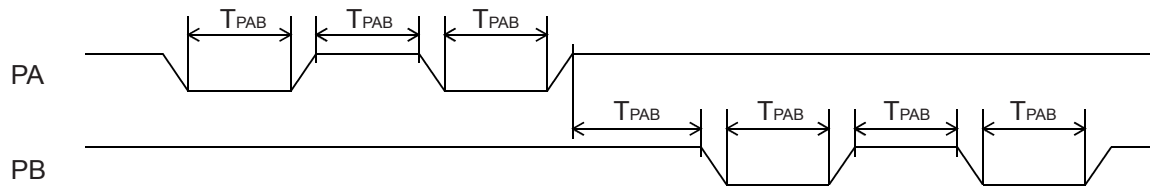

4) When the PA, PB inputs are in the 90° phase-difference mode

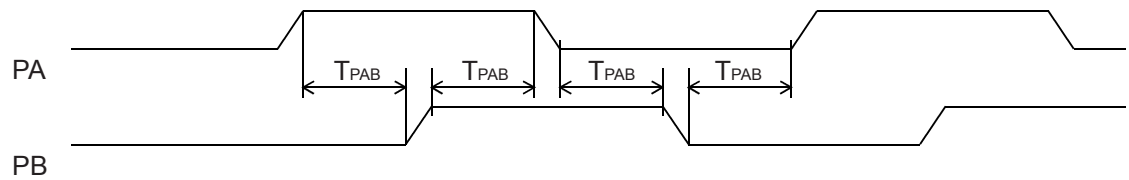

5) Timing for the command mode (when $I/\overline{M} = H$, and $B/\overline{W} = H$)

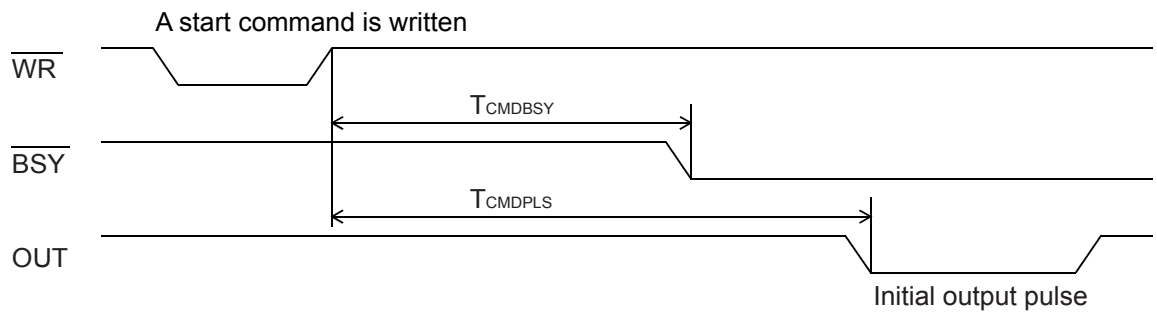

6) Simultaneous start timing

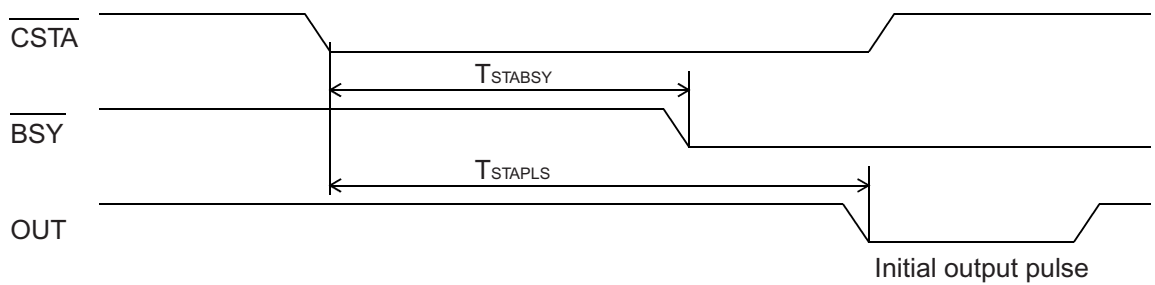

13. External Dimensions

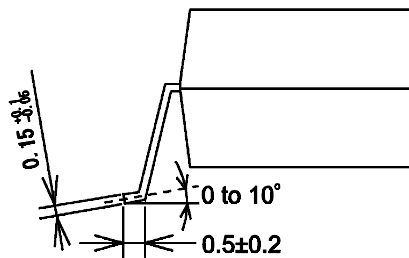
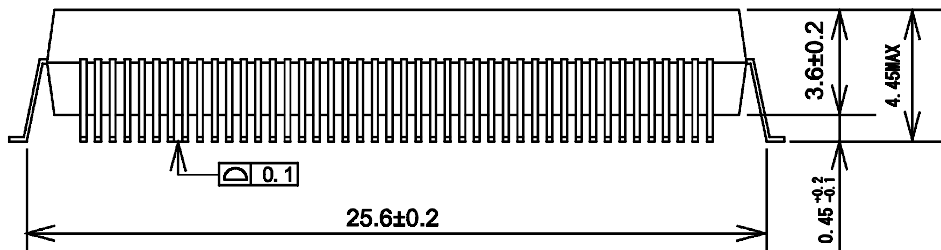
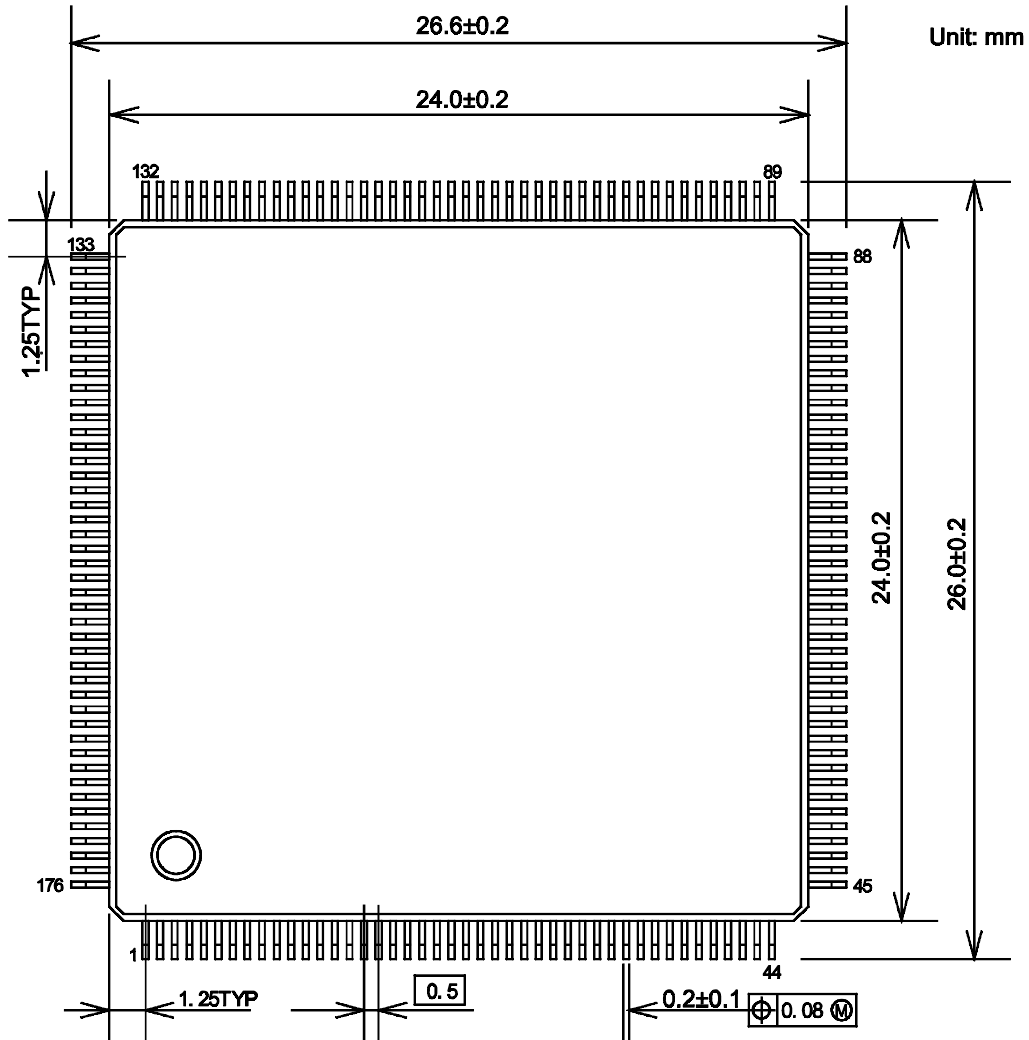

Appendix: List of various items

Appendix 1: List of commands

<Operation commands>

COMB0	Symbol	Description	COMB0	Symbol	Description
05h	CMEMG	Emergency stop	50h	STAFL	FL low speed start
06h	CMSTA	\overline{CSTA} output (simultaneous start)	51h	STAFH	FH low speed start
07h	CMSTP	\overline{CSTP} output (simultaneous stop)	52h	STAD	High speed start 1 (FH low speed -> Deceleration stop)
40h	FCHGL	Immediate change to FL low speed	53h	STAUD	High speed start 2 (acceleration -> FH low speed -> deceleration)
41h	FCHGH	Immediate change to FH low speed	54h	CNTFL	FL low speed start for remaining number of pulses
42h	FSCHL	Decelerate to FL speed	55h	CNTFH	FH low speed start for remaining number of pulses
43h	FSCHH	Accelerate to FH speed	56h	CNTD	High speed start 1 for remaining number of pulses
49h	STOP	Immediate stop	57h	CNTUD	High speed start 2 for remaining number of pulses
4Ah	SDSTP	Deceleration stop			

< General-purpose port control commands>

COMB0	Symbol	Description	COMB0	Symbol	Description
10h	P0RST	Set the P0 terminal LOW	18h	P0SET	Set the P0 terminal HIGH
11h	P1RST	Set the P1 terminal LOW	19h	P1SET	Set the P1 terminal HIGH
12h	P2RST	Set the P2 terminal LOW	1Ah	P2SET	Set the P2 terminal HIGH
13h	P3RST	Set the P3 terminal LOW	1Bh	P3SET	Set the P3 terminal HIGH
14h	P4RST	Set the P4 terminal LOW	1Ch	P4SET	Set the P4 terminal HIGH
15h	P5RST	Set the P5 terminal LOW	1Dh	P5SET	Set the P5 terminal HIGH
16h	P6RST	Set the P6 terminal LOW	1Eh	P6SET	Set the P6 terminal HIGH
17h	P7RST	Set the P7 terminal LOW	1Fh	P7SET	Set the P7 terminal HIGH

<Control commands>

COMB0	Symbol	Description	COMB0	Symbol	Description
00h	NOP	(Invalid command)	26h	PRECAN	Clear the operation pre-register
04h	SRST	Software reset	27h	PCPCAN	Clear the RCMP5 pre-register
20h	CUN1R	Reset COUNTER1 (command position)	28h	STAON	Substitute PCS input
21h	CUN2R	Reset COUNTER2 (mechanical position)	29h	LTCH	Substitute LTC input
22h	CUN3R	Reset COUNTER3 (deflection counter)	2Ah	SPSTA	Uses the same process as the \overline{CSTA} input, but for this axis
23h	CUN4R	Reset COUNTER4 (general-purpose)	2Bh	PRESHF	Shift the operation pre-register data
24h	ERCOUT	Output an ERC signal	2Ch	PCPSHF	Shift the RCMP5 pre-register
25h	ERCRS	Reset the ERC signal	4Fh	PRSET	Set the speed change data in the working pre-register.

<Register control commands>

No.	Description	Register					2nd pre-register				
		Name	Read command		Write command		Name	Read command		Write command	
			COMB0	Symbol	COMB0	Symbol		COMB0	Symbol	COMB0	Symbol
1	Number of feed pulses / target position	RMV	D0h	RRMV	90h	WRMV	PRMV	C0h	RPRMV	80h	WPRMV
2	Initial speed	RFL	D1h	RRFL	91h	WRFL	PRFL	C1h	RPRFL	81h	WPRFL
3	Operation speed	RFH	D2h	RRFH	92h	WRFH	PRFH	C2h	RPRFH	82h	WPRFH
4	Acceleration rate	RUR	D3h	RRUR	93h	WRUR	PRUR	C3h	RPRUR	83h	WPRUR
5	Deceleration rate	RDR	D4h	RRDR	94h	WRDR	PRDR	C4h	RPRDR	84h	WPRDR
6	Speed magnification rate	RMG	D5h	RRMG	95h	WRMG	PRMG	C5h	RPRMG	85h	WPRMG
7	Ramping-down point	RDP	D6h	RRDP	96h	WRDP	PRDP	C6h	RPRDP	86h	WPRDP
8	Operation mode	RMD	D7h	RRMD	97h	WRMD	PRMD	C7h	RPRMD	87h	WPRMD
9	Circular interpolation center	RIP	D8h	RRIP	98h	WRIP	PRIP	C8h	RPRIP	88h	WPRIP
10	S-curve range while accelerating	RUS	D9h	RRUS	99h	WRUS	PRUS	C9h	RPRUS	89h	WPRUS
11	S-curve range while decelerating	RDS	DAh	RRDS	9Ah	WRDS	PRDS	CAh	RPRDS	8Ah	WPRDS
12	Feed speed to correct feed distance	RFA	DBh	RRFA	9Bh	WRFA					
13	Environment setting 1	RENV1	DCh	RRENV1	9Ch	WRENV1					
14	Environment setting 2	RENV2	DDh	RRENV2	9Dh	WRENV2					
15	Environment setting 3	RENV3	DEh	RRENV3	9Eh	WRENV3					
16	Environment setting 4	RENV4	DFh	RRENV4	9Fh	WRENV4					
17	Environment setting 5	RENV5	E0h	RRENV5	A0h	WRENV5					
18	Environment setting 6	RENV6	E1h	RRENV6	A1h	WRENV6					
19	Environment setting 7	RENV7	E2h	RRENV7	A2h	WRENV7					
20	COUNTER1 (command position)	RCUN1	E3h	RRCUN1	A3h	WRCUN1					
21	COUNTER2 (mechanical position)	RCUN2	E4h	RRCUN2	A4h	WRCUN2					
22	COUNTER3 (deflection counter)	RCUN3	E5h	RRCUN3	A5h	WRCUN3					
23	COUNTER4 (general-purpose)	RCUN4	E6h	RRCUN4	A6h	WRCUN4					
24	Comparator 1 data	RCMP1	E7h	RRCMP1	A7h	WRCMP1					
25	Comparator 2 data	RCMP2	E8h	RRCMP2	A8h	WRCMP2					
26	Comparator 3 data	RCMP3	E9h	RRCMP3	A9h	WRCMP3					
27	Comparator 4 data	RCMP4	EAh	RRCMP4	AAh	WRCMP4					
28	Comparator 5 data	RCMP5	EBh	RRCMP5	ABh	WRCMP5	PRCP5	CBh	RPRCP5	8Bh	WPRCP5
29	Enable various event interrupts (INTs)	RIRQ	ECh	RRIRQ	ACH	WRIRQ					
30	COUNTER1 latch data	RLTC1	EDh	RRLTC1							
31	COUNTER2 latch data	RLTC2	EEh	RRLTC2							
32	COUNTER3 latch data	RLTC3	EFh	RRLTC3							
33	COUNTER4 latch data	RLTC4	F0h	RRLTC4							
34	Extension status	RSTS	F1h	RRSTS							
35	Error INT status	REST	F2h	RREST							
36	Event INT status	RIST	F3h	RRIST							
37	Positioning counter	RPLS	F4h	RRPLS							
38	EZ counter, speed monitor	RSPD	F5h	RRSPD							
39	Ramping-down point	RSDC	F6h	RRSDC							
40	Number of steps for circular interpolation	RCI	FCh	RRCI	BCh	WRCI	PRCI	CCh	RPRCI	8Ch	WPRCI
41	Counter of steps for circular interpolation	RCIC	FDh	RRCIC							
42	Interpolation status	RIPS	FFh	RRIPS							

Appendix 2: Setting speed pattern

Pre-register	Description	Bit length setting range	Setting range	Register
PRMV	Positioning amount	28	-134,217,728 to 134,217,727 (8000000h) (7FFFFFFh)	RMV
PRFL	Initial speed (FL speed)	16	1 to 65,535 (0FFFFh)	RFL
PRFH	Operation speed (FH speed)	16	1 to 65,535 (0FFFFh)	RFH
PRUR	Acceleration rate	16	1 to 65,535 (0FFFFh)	RUR
PRDR	Deceleration rate Note 1	16	0 to 65,535 (0FFFFh)	RDR
PRMG	Speed magnification rate	12	2 to 4,095 (0FFFh)	RMG
PRDP	Ramping-down point	24	0 to 16,777,215 (0FFFFFFh)	RDP
PRUS	S-curve acceleration range	15	0 to 32,767 (7FFFh)	RUS
PRDS	S-curve deceleration range	15	0 to 32,767 (7FFFh)	RDS

Note 1: If RDR is set to zero, the deceleration rate will be the value set in the RUR.

[Relative position of each register setting for acceleration and deceleration factors]

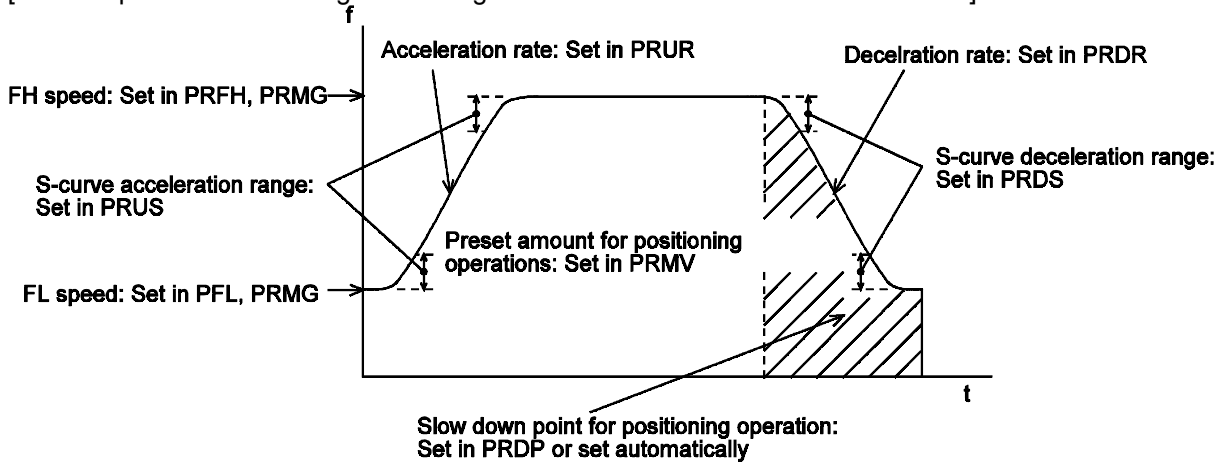

◆ PRFL: FL speed setting register (16-bit)

Specify the speed for FL low speed operations and the start speed for high speed operations (acceleration/deceleration operations) in the range of 1 to 65,535 (0FFFFh).
The speed will be calculated from the value in PRMG.

$$\text{FL speed [pps]} = \text{PRFL} \times \frac{\text{Reference clock frequency [Hz]}}{(\text{PRMG} + 1) \times 65536}$$

◆ PRFH: FH speed setting register (16-bit)

Specify the speed for FH low speed operations and the start speed for high speed operations (acceleration/deceleration operations) in the range of 1 to 65,535 (0FFFFh).
When used for high speed operations (acceleration/deceleration operations), specify a value larger than RFL.
The speed will be calculated from the value placed in PRMG.

$$\text{FH speed [pps]} = \text{PRFH} \times \frac{\text{Reference clock frequency [Hz]}}{(\text{PRMG} + 1) \times 65536}$$

◆ PRUR: Acceleration rate setting register (16-bit)

Specify the acceleration characteristic for high speed operations (acceleration/deceleration operations), in the range of 1 to 65,535 (0FFFFh)

Relationship between the value entered and the acceleration time will be as follows:

1) Linear acceleration (MSMD = 0 in the PRMD register)

$$\text{Acceleration time [s]} = \frac{(\text{PRFH} - \text{PRFL}) \times (\text{PRUR} + 1) \times 4}{\text{Reference clock frequency [Hz]}}$$

2) S-curve without a linear range (MSMD=1 in the PRMD register and PRUS register =0)

$$\text{Acceleration time [s]} = \frac{(\text{PRFH} - \text{PRFL}) \times (\text{PRUR} + 1) \times 8}{\text{Reference clock frequency [Hz]}}$$

3) S-curve with a linear range (MSMD = 1 in the PRMD register and PRUS register >0)

$$\text{Acceleration time [s]} = \frac{(\text{PRFH} - \text{PRFL} + 2 \times \text{PRUS}) \times (\text{PRUR} + 1) \times 4}{\text{Reference clock frequency [Hz]}}$$

◆ PRDR: Deceleration rate setting register (16-bit)

Normally, specify the deceleration characteristics for high speed operations (acceleration /deceleration operations) in the range of 1 to 65,535 (0FFFFh).

Even if the ramping-down point is set to automatic (MSDP = 0 in the PRMD register), the value placed in the PRDR register will be used as the deceleration rate.

However, when PRDR = 0, the deceleration rate will be the value placed in the PRUR.

When the ramping-down point is set automatically, the following limitations are applied.

- While in the Linear interpolation 1 or circular interpolation, and when the synthetic speed constant control function is applied (MIPF = 1 in the PRMD), arrange that (deceleration time) = (acceleration).

- For other cases, arrange that (deceleration time) > (acceleration time x 2)

Setting exceeding the above limitations may not decrease the speed to the specified FL speed when stopping. In this case, use a manual ramping-down point (MSDP = 1 in the PRMD register).

The relationship between the value entered and the deceleration time is as follows.

1) Linear deceleration (MSMD = 0 in the PRMD register)

$$\text{Deceleration time [s]} = \frac{(\text{PRFH} - \text{PRFL}) \times (\text{PRDR} + 1) \times 4}{\text{Reference clock frequency [Hz]}}$$

2) S-curve deceleration without a linear range (MSMD=1 in the PRMD register and PRDS register = 0)

$$\text{Deceleration time [s]} = \frac{(\text{PRFH} - \text{PRFL}) \times (\text{PRDR} + 1) \times 8}{\text{Reference clock frequency [Hz]}}$$

3) S-curve deceleration with a linear range (MSMD=1 in the PRMD register and PRDS register > 0)

$$\text{Deceleration time [s]} = \frac{(\text{PRFH} - \text{PRFL} + 2 \times \text{PRDS}) \times (\text{PRDR} + 1) \times 4}{\text{Reference clock frequency [Hz]}}$$

◆ PRMG: Magnification rate register (12-bit)

Specify the relationship between the PRFL and PRFH settings and the speed, in the range of 2 to 4,095 (0FFFh). As the magnification rate is increased, the speed setting units will tend to be approximations. Normally set the magnification rate as low as possible.

The relationship between the value entered and the magnification rate is as follows.

$$\text{Magnification rate} = \frac{\text{Reference clock frequency [Hz]}}{(\text{PRMG} + 1) \times 65536}$$

[Magnification rate setting example, when the reference clock =19.6608 MHz] (Output speed unit: pps)

Setting	Magnification rate	Output speed range	Setting	Magnification rate	Output speed range
2999 (0BB7h)	0.1	0.1 to 6,553.5	59 (3Bh)	5	5 to 327,675
1499 (5DBh)	0.2	0.2 to 13,107.0	29 (1Dh)	10	10 to 655,350
599 (257h)	0.5	0.5 to 32,767.5	14 (0Eh)	20	20 to 1,310,700
299 (12Bh)	1	1 to 65,535	5 (5h)	50	50 to 3,276,750
149 (95h)	2	2 to 131,070	2 (2h)	100	100 to 6,553,500

◆ PRDP: Ramping-down point register (24-bits)

Specify the value used to determine the deceleration start point for positioning operations that include acceleration and deceleration

The meaning of the value specified in the PRDP changes with the "ramping-down point setting method", (MSD0) in the PRMD register.

<When set to manual> (MSDP = 1 in the PRMD register)

The number of pulses at which to start deceleration, set in the range of 0 to 16,777,215 (0FFFFFFh).

The optimum value for the ramping-down point can be calculated as shown in the equation below.

1) Linear deceleration (MSMD=0 of the PRMD register)

$$\text{Optimum value [Number of pulses]} = \frac{(\text{PRFH}^2 - \text{PRFL}^2) \times (\text{PRDR} + 1)}{(\text{PRMG} + 1) \times 32768}$$

However, the optimum value for a triangle start, without changing the value in the PRFH register while turning OFF the FH correction function (MADJ = 1 in the PRMD register) will be calculated as shown in the next equation below.

(When using idling control, modify the value for PRMV in the equation below by deducting the number of idling pulses from the value placed in the PRMV register. The number of idling pulses will be "1 to 62 when IDL = 2 to 7 in RNVI5.)

$$\text{Optimum value [Number of pulses]} = \frac{\text{PRMV} \times (\text{PRDR} + 1)}{\text{PRUR} + \text{PRDR} + 2}$$

2) S-curve deceleration without a linear range

(MSMD=1 in the PRMD register and the PRDS register =0)

$$\text{Optimum value [Number of pulses]} = \frac{(\text{PRFH}^2 - \text{RFL}^2) \times (\text{PRDR} + 1) \times 2}{(\text{PRMG} + 1) \times 32768}$$

3) S-curve deceleration with a linear range (MSMD=1 in the PRMD register and the PRDS register >0)

$$\text{Optimum value [Number of pulses]} = \frac{(\text{PRFH} + \text{PRFL}) \times (\text{PRFH} - \text{PRFL} + 2 \times \text{PRDS}) \times (\text{RDR} + 1)}{(\text{PRMG} + 1) \times 32768}$$

Start deceleration at the point when the (positioning counter value) ≤ (PRDP set value).

<When set to automatic (MSDP = 0 in the PRMD register)>

This is an offset value for the automatically set ramping-down point. Set in the range of -8,388,608 (800000h) to 8,388,607(7FFFFFFh).

When the offset value is a positive number, the axis will start deceleration at an earlier stage and will feed at the FL speed after decelerating. When a negative number is entered, the deceleration start timing will be delayed. If the offset is not required, set to zero.

When the value for the ramping-down point is smaller than the optimum value, the speed when stopping will be faster than the FL speed. On the other hand, if it is larger than the optimum value, the axis will feed at FL low speed after decelerating.

◆ PRUS: S-curve acceleration range register (15-bit)

Specify the S-curve acceleration range for S-curve acceleration/deceleration operations in the range of 1 to 32,767 (7FFFh).

The S-curve acceleration range S_{SU} will be calculated from the value placed in PRMG.

$$S_{SU} [\text{pps}] = \text{PRUS} \times \frac{\text{Reference clock frequency [Hz]}}{(\text{PRMG} + 1) \times 65536}$$

In other words, speeds between the FL speed and (FL speed + S_{SU}), and between (FH speed - S_{SU}) and the FH speed, will be S-curve acceleration operations. Intermediate speeds will use linear acceleration.

However, if zero is specified, "(PRFH - PRFL) / 2" will be used for internal calculations, and the operation will be an S-curve acceleration without a linear component.

◆ PRDS: S-curve deceleration range setting register (15-bit)

Specify the S-curve deceleration range for S-curve acceleration/deceleration operations in the range of 1 to 32,767 (7FFFh).

The S-curve acceleration range S_{SU} will be calculated from the value placed in PRMG.

$$S_{SD} [\text{pps}] = \text{PRDS} \times \frac{\text{Reference clock frequency [Hz]}}{(\text{PRMG} + 1) \times 65536}$$

In other words, speeds between the FL speed (FL speed + S_{SD}), and between (FH speed - S_{SD}) and the FH speed, will be S-curve deceleration operations. Intermediate speeds will use linear deceleration.

However, if zero is specified, "(PRFH - PRFL) / 2" will be used for internal calculations, and the operation will be an S-curve deceleration without a linear component.

Appendix 3: Label list

Label	Type	Position	Description	Reference
A0	Terminal name	6	Address bus 0 (LSB)	P7, 16, 17
A1	Terminal name	7	Address bus 1	P7, 16, 17
A2	Terminal name	8	Address bus 2	P7, 16, 17
A3	Terminal name	9	Address bus 3	P7, 16, 17
A4	Terminal name	10	Address bus 4 (MSB)	P7, 16, 17
ADJ0 to 1	Register bit	RENV6 12-13	Select the feed amount correction method	P45
ALML	Register bit	RENV1 9	Set the input logic for the ALM signal (0: Negative, 1: Positive)	P36, 108
ALMM	Register bit	RENV1 8	Select the process to use when the ALM input is ON (0: Immediate stop, 1: Deceleration stop)	P36, 108
ALMu	Terminal name	134	U axis driver alarm signal (to stop the axis)	P9, 108
ALMx	Terminal name	38	X axis driver alarm signal (to stop the axis)	P9, 108
ALMy	Terminal name	70	Y axis driver alarm signal (to stop the axis)	P9, 108
ALMz	Terminal name	102	Z axis driver alarm signal (to stop the axis)	P9, 108
AS0 to 15	Register bit	RSPD 0-15	Monitor current speed	P53
BR0 to 11	Register bit	RENV6 0-11	Specify a backlash correction or slip correction amount.	P45, 126
BSYC	Register bit	RENV3 14	Increment/decrement COUNTER4 only while in operation (BSY = L)	P41, 117
BSY \bar{u}	Terminal name	148	Operation monitor output for the U axis	P10
BSY \bar{x}	Terminal name	60	Operation monitor output for the X axis	P10
BSY \bar{y}	Terminal name	81	Operation monitor output for the Y axis	P10
BSY \bar{z}	Terminal name	125	Operation monitor output for the Z axis	P10
BUFB0	Byte map name	4 for Z80	Write/read the input/output buffer (bits 0 to 7).	P16, 18
BUFB1	Byte map name	5 for Z80	Write/read the input/output buffer (bits 8 to 15)	P16, 18
BUFB2	Byte map name	6 for Z80	Write/read the input/output buffer (bits 16 to 23)	P16, 18
BUFB3	Byte map name	7 for Z80	Write/read the input/output buffer (bits 24 to 31)	P16, 18
BUFW0	Word map name	4 for 80886	Write/read the input/output buffer (bits 0 to 15)	P17, 18
BUFW1	Word map name	6 for 8086	Write/read the input/output buffer (bits 16 to 31)	P17, 18
C1C0 to 1	Register bit	RENV4 0-1	Select a comparison counter for comparator1	P42, 118
C1D0 to 1	Register bit	RENV4 5-6	Select a process to execute when the comparator1 conditions are met	P42, 119
C1S0 to 2	Register bit	RENV4 2-4	Select a comparison method for comparator1	P42, 119
C1RM	Register bit	RENV4 7	Set COUNTER1 for ring count operation using Comparator 1.	P42, 125
C2C0 to 1	Register bit	RENV4 8-9	Select a comparison counter for comparator2	P42, 118
C2D0 to 1	Register bit	RENV4 13-14	Select a process to execute when the comparator2 conditions are met	P42, 119
C2S0 to 2	Register bit	RENV4 10-12	Select a comparison method for comparator2	P42, 119
C2RM	Register bit	RENV4 15	Set COUNTER2 for ring count operation using Comparator 2	P42, 125
C3C0 to 1	Register bit	RENV4 16-17	Select a comparison counter for comparator3	P42, 118
C3D0 to 1	Register bit	RENV4 21-22	Select a process to execute when the comparator3 conditions are met	P43, 119
C3S0 to 2	Register bit	RENV4 18-20	Select a comparison method for comparator3	P43, 119
C4C0 to 1	Register bit	RENV4 24-25	Select a comparison counter for comparator4	P43, 118
C4D0 to 1	Register bit	RENV4 30-31	Select a process to execute when the comparator4 conditions are met	P43, 119
C4S0 to 3	Register bit	RENV4 26-29	Select a comparison method for comparator4	P43, 119
C5C0 to 2	Register bit	RENV5 0-2	Select a comparison counter for comparator5	P44, 118
C5D0 to 1	Register bit	RENV5 6-7	Select a process to execute when the comparator5 conditions are met	P44, 118
C5S0 to 2	Register bit	RENV5 3-5	Select a comparison method for comparator5	P44, 119
CEMG	Terminal name	170	Emergency stop signal	P8, 112
CI20 to 21	Register bit	RENV3 8-9	Specify the input count COUNTER2 (mechanical position)	P41, 113
CI30 to 31	Register bit	RENV3 10-11	Specify the input count COUNTER3 (deflection counter)	P41, 113
CI40 to 41	Register bit	RENV3 12-13	Specify the input count COUNTER4 (general-purpose)	P41, 113
CLK	Terminal name	164	Reference clock (19.6608 MHz as standard)	P7
CLR0 to 1	Register bit	RENV1 20-21	Select the CLR input mode	P37, 115
CLRu	Terminal name	151	Clear the counter input for the U axis	P10, 115
CLR \bar{x}	Terminal name	50	Clear the counter input for the X axis	P10, 115
CLR \bar{y}	Terminal name	86	Clear the counter input for the Y axis	P10, 115
CLR \bar{z}	Terminal name	114	Clear the counter input for the Z axis	P10, 115
CMEMG	Command	05h	Emergency stop	P22, 112
CMSTA	Command	06h	Output CSTA (simultaneous start) signal	P22, 110
CMSTP	Command	07h	Output CSTP (simultaneous stop) signal	P22, 112
CND0 to 3	Register bit	RSTS 0-3	Operation status monitor	P50
CNTD	Command	56h	Remaining high speed start pulses (FH low speed -> Deceleration stop)	P22
CNTFH	Command	55h	Remaining pulses FH low speed start pulses	P22
CNTFL	Command	54h	Remaining pulses FL low speed start pulses	P22
CNTUD	Command	57h	Remaining high speed start pulses (accelerate -> FH low speed -> deceleration stop)	P22
COMB0	Byte map name	0 when Z80	Write control command	P16, 18, 22
COMB1	Byte map name	1 when Z80	Axis selection	P16, 18, 21
COMW	Word map name	0 when 8086	Assign an axis, or write a control command	P17, 18
COUNTER1	Circuit name		28-bit counter for command position control	P2, 113
COUNTER2	Circuit name		28-bit counter for mechanical position control	P2, 113
COUNTER3	Circuit name		16-bit counter for the deflection counter	P2, 113
COUNTER4	Circuit name		28-bit counter for the general-purpose counter	P2, 113
\bar{CS}	Terminal name	3	Chip select signal	P7
\bar{CSTA}	Terminal name	168	Simultaneous start signal	P8, 109
\bar{CSTP}	Terminal name	169	Simultaneous stop signal	P8, 111

Label	Type	Position	Description	Reference
CU1B	Register bit	RENV3 24	Operate COUNTER2 (mechanical position) with backlash/slip correction	P41, 126
CU1C	Register bit	RENV3 16	Reset COUNTER1 (command position) by turning ON the CLR input.	P41, 115
CU1L	Register bit	RENV5 24	Reset COUNTER1 (command position) right after latching the count value.	P44, 115
CU1R	Register bit	RENV3 20	Reset COUNTER1 (command position) when the zero return is complete	P41, 115
CU2B	Register bit	RENV3 25	Operate COUNTER2 (mechanical position) with backlash/slip correction	P41, 126
CU2C	Register bit	RENV3 17	Reset COUNTER2 (mechanical position) by turning ON the CLR input	P41, 115
CU2H	Register bit	RENV3 29	Stop the count on COUNTER2 (mechanical position)	P41, 117
CU2L	Register bit	RENV5 25	Reset COUNTER2 (mechanical position) right after latching the count value.	P44, 115
CU2R	Register bit	RENV3 21	Reset COUNTER2 (mechanical position) when the zero return is complete	P41, 115
CU3B	Register bit	RENV3 25	Operate COUNTER3 (deflection) with backlash/slip correction	P41, 126
CU3C	Register bit	RENV3 18	Reset the COUNTER3 (deflection) by turning ON the CLR input.	P41, 115
CU3H	Register bit	RENV3 30	Stop the count on COUNTER3 (deflection)	P41, 117
CU3L	Register bit	RENV5 26	Reset COUNTER3 (deflection) right after latching the count value.	P44, 115
CU3R	Register bit	RENV3 22	Reset COUNTER3 (deflection) when the zero return is complete	P41, 115
CU4B	Register bit	RENV3 27	Operate COUNTER4 (general-purpose) backlash/slip correction	P41, 126
CU4C	Register bit	RENV3 19	Reset COUNTER4 (general-purpose) by turning ON the CLR input	P41, 115
CU4H	Register bit	RENV3 31	Stop the count on COUNTER4 (general-purpose)	P41, 117
CU4L	Register bit	RENV5 27	Reset COUNTER4 (general-purpose) right after latching the count value.	P44, 115
CU4R	Register bit	RENV3 23	Reset COUNTER4 (general-purpose) when the zero position operation is complete	P41, 115
CUN1R	Command	20h	Reset COUNTER1 (command position)	P24, 115
CUN2R	Command	21h	Reset COUNTER2 (mechanical position)	P24, 115
CUN3R	Command	22h	Reset COUNTER3 (deflection counter)	P24, 115
CUN4R	Command	23h	Reset COUNTER4 (general purpose)	P24, 115
D0	Terminal name	15	Data bus 0 (LSB)	P8
D1	Terminal name	15	Data bus 1	P8
D10	Terminal name	27	Data bus 10	P8
D11	Terminal name	28	Data bus 11	P8
D12	Terminal name	29	Data bus 12	P8
D13	Terminal name	30	Data bus 13	P8
D14	Terminal name	31	Data bus 14	P8
D15	Terminal name	32	Data bus 15 (MSB)	P8
D2	Terminal name	18	Data bus 2	P8
D3	Terminal name	19	Data bus 3	P8
D4	Terminal name	20	Data bus 4	P8
D5	Terminal name	21	Data bus 5	P8
D6	Terminal name	22	Data bus 6	P8
D7	Terminal name	23	Data bus 7	P8
D8	Terminal name	24	Data bus 8	P8
D9	Terminal name	26	Data bus 9	P8
DIRu	Terminal name	146	Motor drive direction signal for the U axis	P9, 99
DIRx	Terminal name	58	Motor drive direction signal for the X axis	P9, 99
DIRy	Terminal name	79	Motor drive direction signal for the Y axis	P9, 99
DIRz	Terminal name	123	Motor drive direction signal for the Z axis	P9, 99
DRF	Register bit	RENV1 27	Apply a filter to +DR, -DR signal input	P37, 63
DRL	Register bit	RENV1 25	Select +DR, -DR signal input logic (0: Negative logic, 1: Positive logic)	P37, 63
+DRu	Terminal name	141	Manual (+) input for the U axis	P9, 63
-DRu	Terminal name	142	Manual (-) input for the U axis	P9, 63
+DRx	Terminal name	46	Manual (+) input for the X axis	P9, 63
-DRx	Terminal name	47	Manual (-) input for the X axis	P9, 63
+DRy	Terminal name	82	Manual (+) input for the Y axis	P9, 63
-DRy	Terminal name	83	Manual (-) input for the Y axis	P9, 63
+DRz	Terminal name	110	Manual (+) input for the Z axis	P9, 63
-DRz	Terminal name	111	Manual (-) input for the Z axis	P9, 63
DTMF	Register bit	RENV1 28	Turn OFF the direction change timer (0.2 msec)	P37
EAu	Terminal name	135	Encoder A phase signal for the U axis	P9
EAx	Terminal name	40	Encoder A phase signal for the X axis	P9
EAy	Terminal name	71	Encoder A phase signal for the Y axis	P9
EAz	Terminal name	103	Encoder A phase signal for the Z axis	P9
EBu	Terminal name	136	Encoder B phase signal for the U axis	P9
EBx	Terminal name	41	Encoder B phase signal for the X axis.	P9
EBy	Terminal name	72	Encoder B phase signal for the Y axis	P9
EBz	Terminal name	104	Encoder B phase signal for the Z axis	P9
ECZ0 to 3	Register bit	RSPD 16-19	Read the count value of the EZ input to monitor the zero return	P53
EDIR	Register bit	RENV2 22	Reverse the EA, EB input count direction	P39, 114
EIM0 to 1	Register bit	RENV2 20-21	Specify the EA, EB input parameters	P39, 114
EINF	Register bit	RENV2 18	Apply a noise filter to the EA/EB input	P38, 114
ELLu	Terminal name	174	Set the input logic of the end limit signal for the U axis	P8, 102
ELLx	Terminal name	171	Set the input logic of the end limit signal for the X axis	P8, 102
ELLy	Terminal name	172	Select the input logic of the end limit signal for the Y axis	P8, 102
ELLz	Terminal name	173	Set the input logic of the end limit signal for the Z axis	P8, 102
ELM	Register bit	RENV1 3	Select the process to execute when the EL input is ON (0: Immediate stop, 1:	P36, 102

Label	Type	Position	Description	Reference
			Deceleration stop)	
+ELLu	Terminal name	130	(+) end limit signal for the U axis	P8, 102
-ELLu	Terminal name	131	(-) end limit signal for the U axis	P8, 102
+ELLx	Terminal name	34	(+) end limit signal for the X axis	P8, 102
-ELLx	Terminal name	35	(-) end limit signal for the X axis	P8, 102
+ELLy	Terminal name	66	(+) end limit signal for the Y axis	P8, 102
-ELLy	Terminal name	67	(-) end limit signal for the Y axis.	P8, 102
+ELLz	Terminal name	97	(+) end limit signal for the Z axis	P8, 102
-ELLz	Terminal name	98	(-) end limit signal for the Z axis	P8, 102
EOFF	Register bit	RENV2 30	Invalid EA, EB input	P39, 114
EPW0 to 2	Register bit	RENV1 12-14	Specify the ERC output signal pulse width	P36, 107
ERCL	Register bit	RENV1 15	Set the output logic of the ERC signal (0: Negative logic, 1: Positive logic)	P36, 107
ERCOUT	Command	24h	Output an ERC signal	P24, 108
ERCRST	Command	25h	Reset the output when the ERC signal is set to level output	P24, 108
ERCu	Terminal name	147	Driver deflection clear output for the U axis	P10, 107
ERCx	Terminal name	59	Driver deflection clear output for the X axis	P10, 107
ERCy	Terminal name	80	Driver deflection clear output for the Y axis	P10, 107
ERCz	Terminal name	124	Driver deflection clear output for the Z axis	P10, 107
EROE	Register bit	RENV1 10	Automatic output of the ERC signal	P36, 107
EROR	Register bit	RENV1 11	Auto output an ERC signal when the zero return is complete	P36, 107
ESAL	Register bit	REST 7	Equals 1 when stopped by the ALM input turning ON	P51, 108
ESAO	Register bit	REST 15	Equals 1 when the positioning counter exceeds the count range	P51
ESC1	Register bit	REST 0	Stopped when the comparator1 conditions (+SL) are met	P51
ESC2	Register bit	REST 1	Stopped when the comparator2 conditions (-SL) are met	P51
ESC3	Register bit	REST 2	Stopped when the comparator3 conditions (detect out-of-step) are met	P51
ESC4	Register bit	REST 3	Stopped when the comparator4 conditions are met.	P51
ESC5	Register bit	REST 4	Stopped when the comparator5 conditions are met	P51
ESDT	Register bit	REST 12	Stopped by an operation data error	P51
ESEE	Register bit	REST 16	An EA/EB input error occurred	P51
ESEM	Register bit	REST 9	Stops by inputting CEMG ON input	P51, 112
ESIP	Register bit	REST 13	When any other axis in an interpolation operation stops in an emergency, this axis stops simultaneously	P51
ESML	Register bit	REST 6	Stopped because the nEL input turned ON	P51, 102
ESPE	Register bit	REST 17	A PA/PB input error occurred	P51, 60
ESPL	Register bit	REST 5	Stopped because the + EL input turned ON	P51, 103
ESPO	Register bit	REST 14	The PA/PB input buffer counter overflowed	P51, 60
ESSD	Register bit	REST 10	Deceleration stop caused by the SD input turning ON	P51, 104
ESSP	Register bit	REST 8	Stops by inputting CSSTP ON input	P51
EZL	Register bit	RENV2 23	Set the input logic for the EZ signal (0: Falling, 1: Rising)	P39, 65
EZu	Terminal name	137	U axis encoder Z phase signal	P9, 65
EZx	Terminal name	42	X axis encoder Z phase signal	P9, 65
EZy	Terminal name	73	Y axis encoder Z phase signal	P9, 65
EZz	Terminal name	106	Z axis encoder Z phase signal	P9, 65
ETW0 to 1	Register bits	RENV1 16-17	Specify the ERC signal OFF timer	P36, 108
EZD0 to 3	Register bits	RENV3 4-7	Enter an EZ count value for a zero return	P41, 65
FCHGH	Command	41h	Change immediately to FH speed	P22
FCHGL	Command	40h	Change immediately to FL speed	P22
FLTR	Register bit	RENV1 26	Apply input filter	P37
FSCHH	Command	43h	Accelerate to FH speed	P22
FSCHL	Command	42h	Accelerate to FL speed	P22
FT0 to 15	Register bits	RENV7 16-31	Enter an FT time for the vibration reduction function	P45, 127
IDC0 to 2	Register bits	RSPD 20-22	Monitor the idling count (0 to 7 pulses)	P53, 101
IDL0 to 2	Register bits	RENV5 8-10	Enter the number of idling pulse (0 to 7 pulses)	P44, 101
IDXM	Register bit	RENV4 23	Select IDX output specification (0: Level output, 1: Pulse output)	P43, 124
IEND	Register bit	RENV2 27	Specify that the stop interrupt will be output.	P39, 136
IF0	Terminal name	1	CPU-I/F mode selection 0	P7, 13
IF1	Terminal name	2	CPU-I/F mode selection 1	P7, 13
IFB	Terminal name	14	Busy CPU-I/F	P8
INPL	Register bit	RENV1 22		P37, 106
INPu	Terminal name	150	In position input for the U axis	P10, 106
INPx	Terminal name	49	In position input for the X axis	P10, 106
INPy	Terminal name	85	In position input for the Y axis	P10, 106
INPz	Terminal name	113	In position input for the Z axis	P10, 106
INT	Terminal name	11	Interrupt request signal	P7, 135
INTM	Register bit	RENV1 29	Mask the INT output terminal	P37, 136
IOF0 to 7	Sub-status bits	SSTSW 0-7	Read the P0 to P7 terminal status.	P20
IOPB	Byte map name	"2 " when using a Z80	Read the general I/O port	P16, 20
IPCC	Register bit	RIPS 19	Executing a CCW circular interpolation	P54
IPCW	Register bit	RIPS 18	Executing a CW circular interpolation	P54
IPE	Register bit	RIPS 17	Executing a linear interpolation by entering master axis feed amount	P54
IPEu	Register bit	RIPS 7	U axis linear interpolation mode from a specified master axis feed amount	P54

Label	Type	Position	Description	Reference
IPEx	Register bit	RIPS 4	X axis linear interpolation mode from a specified master axis feed amount	P54
IPEy	Register bit	RIPS 5	Y axis linear interpolation mode from a specified master axis feed amount	P54
IPEz	Register bit	RIPS 6	Z axis linear interpolation mode from a specified master axis feed amount	P54
IPFu	Register bit	RIPS 15	Specify a synthetic constant speed for the U axis	P54
IPFx	Register bit	RIPS 12	Specify a synthetic constant speed for the X axis	P54
IPFy	Register bit	RIPS 13	Specify synthetic constant speed for the Y axis	P54
IPFz	Register bit	RIPS 14	Specify a synthetic constant speed for the Z axis	P54
IPL	Register bit	RIPS 16	Executing a normal linear interpolation	P54
IPLu	Register bit	RIPS 3	U axis is in normal linear interpolation mode	P54
IPLx	Register bit	RIPS 0	X axis is in normal linear interpolation mode	P54
IPLy	Register bit	RIPS 1	Y axis is in normal linear interpolation mode	P54
IPLz	Register bit	RIPS 2	Z axis is in normal linear interpolation mode	P54
IPSu	Register bit	RIPS 11	U axis is in circular interpolation mode	P54
IPsx	Register bit	RIPS 8	X axis is in circular interpolation mode	P54
IPSy	Register bit	RIPS 9	Y axis is in circular interpolation mode	P54
IPsz	Register bit	RIPS 10	Z axis is in circular interpolation mode	P54
IRC1	Register bit	RIRQ 8	Enable an INT when the comparator1 conditions are met	P48,137
IRC2	Register bit	RIRQ 9	Enable an INT when the comparator2 conditions are met	P48,137
IRC3	Register bit	RIRQ 10	Enable an INT when the comparator3 conditions are met	P48,137
IRC4	Register bit	RIRQ 11	Enable an INT when the comparator4 conditions are met	P48,137
IRC5	Register bit	RIRQ 12	Enable an INT when the comparator5 conditions are met	P48,137
IRCL	Register bit	RIRQ 13	Enable an INT when the count value is reset by a CLR input	P48,137
IRDE	Register bit	RIRQ 7	Enable an INT when the deceleration is finished	P48,137
IRDR	Register bit	RIRQ 17	Enable an INT when the ±DR input changes	P48,137
IRDS	Register bit	RIRQ 6	Enable an INT when the deceleration starts	P48,137
IREN	Register bit	RIRQ 0	Enable an INT when there is a normal stop	P48,137
IRLT	Register bit	RIRQ 14	Enable an INT when the count value is latched by an LTC input	P48,137
IRN	Register bit	RIRQ 1	Enable INT by continuing with the next operation.	P48,137
IRND	Register bit	RIRQ 3	Enable an INT when writing to the 2nd pre-register for comparator5 is enabled	P48,137
IRNM	Register bit	RIRQ 2	Enable an INT when writing to 2nd pre-register for operation is enabled	P48,137
IROL	Register bit	RIRQ 15	Enable an INT when the count value is latched by an ORG input	P48,137
IRSA	Register bit	RIRQ 18	Enable an INT by turning ON the CSTA input	P48,137
IRSD	Register bit	RIRQ 16	Enable an INT by turning ON the SD input	P48,137
IRUE	Register bit	RIRQ 5	Enable an INT when the acceleration is finished	P48,137
IRUS	Register bit	RIRQ 4	Enable an INT when acceleration starts	P48,137
ISC1	Register bit	RIST 8	Comparator 1 conditioned status	P52,137
ISC2	Register bit	RIST 9	Comparator 2 conditioned status	P52,137
ISC3	Register bit	RIST 10	Comparator 3 conditioned status	P52,137
ISC4	Register bit	RIST 11	Comparator 4 conditioned status	P52,137
ISC5	Register bit	RIST 12	Comparator 5 conditioned status	P52,137
ISCL	Register bit	RIST 13	Reset the count value when a CLR signal is input	P52,137
ISDE	Register bit	RIST 7	Equals 1 when deceleration is finished	P52,137
ISDS	Register bit	RIST 6	Equals 1 when deceleration starts	P52,137
ISEN	Register bit	RIST 0	Equals 1 when stopped automatically	P52,137
ISLT	Register bit	RIST 14	Equals 1 when the count value is latched by an LTC input	P52,137
ISMD	Register bit	RIST 18	Equals 1 when a nDR input signal is input.	P52,137
ISN	Register bit	RIST 1	To start the next operation continuously.	P52,137
ISND	Register bit	RIST 3	Enable writing to the 2nd pre-register for comparator5	P52,137
ISNM	Register bit	RIST 2	Enable writing to the 2nd pre-register for operations	P52,137
ISOL	Register bit	RIST 15	Latched count value from the ORG input	P52,137
ISPD	Register bit	RIST 17	Equals 1 when the +DR input is ON	P52,137
ISSA	Register bit	RIST 19	Equals 1 when the CSTA input is ON	P52,137
ISSD	Register bit	RIST 16	Equals 1 when the SD input is ON	P52,137
ISUE	Register bit	RIST 5	Equals 1 when the acceleration is finished	P52,137
ISUS	Register bit	RIST 4	Equals 1 when to start acceleration	P52,137
LTCH	Command	29h	Substitute the LTC input (for counting or latching)	P24, 116
LTCL	Register bit	RENV1 23	Select the trigger edge for the LTC signal (0: Falling edge, 1: Rising edge)	P37, 116
LTCu	Terminal name	152	Latch the input for the U axis	P10, 116
LTCx	Terminal name	51	Latch the input for the X axis	P10, 116
LTCy	Terminal name	87	Latch the input for the Y axis	P10, 116
LTCz	Terminal name	115	Latch the input for the Z axis	P10, 116
LTFD	Register bit	RENV5 14	Latch the current speed data in place of COUNTER3	P44, 116
LTM0 to 1	Register bits	RENV5 12-13	Specify the latch timing of COUNTERS 1 to 4	P44, 116
LTOF	Register bit	RENV5 15	Stop the latch using hardware timing	P44, 116
MADJ	Register bit	RMD 26	Disable the FH correction function	P34
MAX0 to 3	Register bits	RMD 20-21	Specify the axis used to control stopping for a simultaneous start	P34, 128
MCCE	Register bit	RMD 11	Stop the operation of COUNTER1 (command position)	P34, 117
MENI	Register bit	RMD 7	Does not output a stop INT between blocks while in continuous operation using the pre-register.	P34, 136
METM	Register bit	RMD 12	Select the operation completion timing (0: Stop at the end of a cycle, 1: Stop on a pulse)	P34, 100
MINP	Register bit	RMD 9	The operation is complete when the INP input turns ON	P34, 106

Label	Type	Position	Description	Reference
MIPF	Register bit	RMD 15	Enable a synthetic constant speed during an interpolation operation	P34, 78
MOD	Register bits	RMD 0-6	Operation mode selection	P34
MPCS	Register bit	RMD 14	Start control positioning using a PCI input	P34, 98
MPIE	Register bit	RMD 27	Automatically enter an end point pull in operation at the end of arc interpolation operation.	P34, 81
MSDE	Register bit	RMD 8	Decelerate (decelerate and stop) when the SD input turns ON	P34
MSDP	Register bit	RMD 13	Specify the ramping-down point manually	P34
MSMD	Register bit	RMD 10	S-curve acceleration/deceleration (linear accel/decel when 0)	P34
MSN0 to 1	Register bits	RMD 16-17	Sequence number used to control the operation block	P34
MSPE	Register bit	RMD 24	Enable CSTP input	P34, 111
MSPO	Register bit	RMD 25	Output a CSTP (simultaneous stop) signal when stopped by an error	P34, 111
MSTSB0	Byte map name	0 when using a Z80	Read the main status (bits 0 to 7)	P16, 19
MSTSB1	Byte map name	1 when using a Z80	Read the main status (bits 8 to 15)	P16, 19
MSTSW	Word map name	0 when using an 8086	Read the main status bits (bits 0 to 7)	P17, 19
MSY0 to 1	Register bit	18, 19	Synchronization start timing	P34, 128
NOP	Command	00h	Monitor the output while feeding the X-axis at low speed	P22
ORGL	Register bit	RENV1 7		P36, 65
ORGu	Terminal name	133	Zero point signal for U axis	P9, 65
ORGx	Terminal name	37	Zero point signal for X axis	P9, 65
ORGy	Terminal name	69	Zero point signal for Y axis	P9, 65
ORGz	Terminal name	101	Zero point signal for Z axis	P9, 65
ORM0 to 3	Register bits	RENV3 0-3	Select the input logic for the ORG signal (0: Negative logic, 1: Positive logic)	P40, 66
OTPO to 7	General-purpose port name	OTPW 0-7	Zero position signal for the X axis	P18
OTPB	Byte map name	2 when using a Z80	Zero position signal for the Y axis (valid only for the output specified bits)	P16, 18
OTPW	Word map name	2 when using an 8086	Select the zero return method (valid only for the output specified bits)	P17, 18
OUTu	Terminal name	145	Motor driving pulse signals for U axis	P9, 99
OUTx	Terminal name	57	Motor driving pulse signals for X axis	P9, 99
OUTy	Terminal name	78	Motor driving pulse signals for Y axis	P9, 99
OUTz	Terminal name	122	Motor driving pulse signals for Z axis	P9, 99
P0L	Register bit	RENV2 16	Set output logic of P0 terminal.	P23, 38
P0u/FUPu	Terminal name	153	General-purpose port 0 for the U axis / Monitor output during acceleration	P10
P0x/FUPx	Terminal name	52	General-purpose port 0 for the X axis / Monitor output during acceleration	P10
P0y/FUPy	Terminal name	89	General-purpose port 0 for the Y axis / Monitor output during acceleration	P10
P0z/FUPz	Terminal name	116	General-purpose port 0 for the Z axis / Monitor output during acceleration	P10
P1u/FDWu	Terminal name	154	General-purpose port 1 for the U axis / Monitor output during acceleration	P10
P1x/FDWx	Terminal name	53	General-purpose port 1 for the X axis / Monitor output during acceleration	P10
P1y/FDWy	Terminal name	90	General-purpose port 1 for the Y axis / Monitor output during acceleration	P10
P1z/FDWz	Terminal name	117	General-purpose port 1 for the Z axis / Monitor output during acceleration	P10
P2u/MVCu	Terminal name	155	General-purpose port 2 for the U axis / Feeding at low speed	P10
P2x/MVCx	Terminal name	54	General-purpose port 2 for the Y axis / Feeding at low speed	P10
P2y/MVCy	Terminal name	91	General-purpose port 2 for the X axis / Feeding at low speed	P10
P2z/MVCz	Terminal name	118	General-purpose port 2 for the Z axis / Feeding at rated speed	P10
P3u/CP1u(+SLu)	Terminal name	156	General-purpose port 3 for the U axis / Comparator 1 (+ software limit) output	P10
P3x/CP1x(+SLx)	Terminal name	55	General-purpose port 3 for the X axis / Comparator 1 (+ software limit) output	P10
P3y/CP1y(+SLy)	Terminal name	92	General-purpose port 3 for the Y axis / Comparator 1 (+ software limit) output	P10
P3z/CP1z(+SLz)	Terminal name	119	General-purpose port 3 for the Z axis / Comparator 1 (+ software limit) output	P10
P4u/CP2u(-SLu)	Terminal name	157	General-purpose port 4 for the U axis / Comparator 2 (+ software limit) output	P11
P4x/CP2x(-SLx)	Terminal name	62	General-purpose port 4 for the X axis / Comparator 2 (+ software limit) output	P11
P4y/CP2y(-SLy)	Terminal name	93	General-purpose port 4 for the Y axis / Comparator 2 (+ software limit) output	P11
P4z/CP2z(-SLz)	Terminal name	120	General-purpose port 4 for the Z axis / Comparator 2 (+ software limit) output	P11
P5u/CP3u	Terminal name	158	General-purpose port 5 for the U axis / Comparator 3 output	P11
P5x/CP3x	Terminal name	63	General-purpose port 5 for the X axis / Comparator 3 output	P11
P5y/CP3y	Terminal name	94	General-purpose port 5 for the Y axis / Comparator 3 output	P11
P5z/CP3z	Terminal name	126	General-purpose port 5 for the Z axis / Comparator 3 output	P11
P6u/CP4u	Terminal name	159	General-purpose port 6 for the U axis / Comparator 4 output	P11
P6x/CP4x	Terminal name	64	General-purpose port 6 for the X axis / Comparator 4 output	P11
P6y/CP4y	Terminal name	95	General-purpose port 6 for the Y axis / Comparator 4 output	P11
P6z/CP4z	Terminal name	128	General-purpose port 6 for the Z axis / Comparator 4 output	P11
P7u/CP5u	Terminal name	160	General-purpose port 7 for the U axis / Comparator 5 output	P11
P7x/CP5x	Terminal name	65	General-purpose port 7 for the X axis / Comparator 5 output	P11
P7y/CP5y	Terminal name	96	General-purpose port 7 for the Y axis / Comparator 5 output	P11
P7z/CP5z	Terminal name	129	General-purpose port 7 for the U axis / Comparator 5 output	P11
P0M0 to 1	Register bits	RENV2 0-1	Specify the P0/FUP terminal details	P38
P0RST	Command	10h	Set the general-purpose output port terminal P0 LOW	P23
P0SET	Command	18h	Set the general-purpose output port terminal P0 HIGH	P23
P1L	Register bit	RENV2 17	Set the P1 terminal output logic (0: Negative logic, 1: Positive logic)	P38

Label	Type	Position	Description	Reference
P1M0 to 1	Register bits	RENV2 2-3	Specify the P1/FDW terminal details	P38
P1RST	Command	11h	Set the general-purpose output port terminal P1 LOW	P23
P1SET	Command	19h	Set the general-purpose output port terminal P1 HIGH	P23
P2M0 to 1z	Register bits	RENV2 4-5	Specify the P2/MVC terminal details	P38
P2RST	Command	12h	Set the general-purpose output port terminal P2 LOW	P23
P2SET	Command	1Ah	Set the general-purpose output port terminal P2 HIGH	P23
P3M0 to 1	Register bits	RENV2 6-7	Specify the P3/CP1 (+SL) terminal details	P38
P3RST	Command	13h	Set the general-purpose output port terminal P3 LOW	P23
P3SET	Command	1Bh	Set the general-purpose output port terminal P3 HIGH	P23
P4M0 to 1	Register bits	RENV2 8-9	Specify the P4/CP2 (-SL) terminal details	P38
P4RST	Command	14h	Set the general-purpose output port terminal P4 LOW	P23
P4SET	Command	1Ch	Set the general-purpose output port terminal P4 HIGH	P23
P5M0 to 1	Register bits	RENV2 10-11	Specify the P5/CP3 terminal details	P38
P5RST	Command	15h	Set the general-purpose output port terminal P5 LOW	P23
P5SET	Command	1Dh	Set the general-purpose output port terminal P5 HIGH	P23
P6M0 to 1	Register bits	RENV2 12-13	Specify the P6/CP4/IDX terminal details	P38
P6RST	Command	16h	Set the general-purpose output port terminal P6 LOW	P23
P6SET	Command	1Eh	Set the general-purpose output port terminal P6 HIGH	P23
P7M0 to 1	Register bits	RENV2 14-15	Specify the P7/CP5 terminal details	P38
P7RST	Command	17h	Set the general-purpose output port terminal P7 LOW	P23
P7SET	Command	1Fh	Set the general-purpose output port terminal P7 HIGH	P23
PAu	Terminal name	138	Manual pulsar phase A input for the U axis	P9, 58
PAX	Terminal name	43	Manual pulsar phase A input for the X axis	P9, 58
PAY	Terminal name	74	Manual pulsar phase A input for the Y axis	P9, 58
PAz	Terminal name	107	Manual pulsar phase A input for the Z axis	P9, 58
PBU	Terminal name	139	Manual pulsar phase B input for the Uaxis	P9, 58
PBX	Terminal name	44	Manual pulsar phase B input for the X axis	P9, 58
PBY	Terminal name	75	Manual pulsar phase B input for the Y axis	P9, 58
PBz	Terminal name	108	Manual pulsar phase B input for the Z axis	P9, 58
PCPCAN	Command	27h	Clear the pre-register (PRCP5) for PCMP5	P24, 30
PCSM	Register bit	30	Allow the PCS input on the local axis CSPA signal	P37
PCSL	Register bit	RENV1 24	Set the input logic for the PCSn signal (0: Negative logic, 1: Positive logic)	P37, 110
PCSu	Terminal name	143	Start positioning control for the U axis	P10, 110
PCSx	Terminal name	48	Start positioning control for the X axis	P10, 110
PCSy	Terminal name	84	Start positioning control for the Y axis	P10, 110
PCSz	Terminal name	112	Start positioning control for the Z axis	P10, 110
PD0 to 10	Register bit	RENV6 16-26	Set a division rate for PA, PB inputs.	P45, 58
PDIR	Register bit	RENV2 26	Reverse the counting direction of the PA and PB inputs	P39, 60
PDTC	Register bit	31	Keep the pulse width at a 50% duty cycle	P37
PEu	Terminal name	140	Enable the PA, PB, +DR, -DR inputs for U axis	P9, 58
PEx	Terminal name	45	Enable the PA, PB, +DR, -DR inputs for X axis	P9, 58
PEy	Terminal name	76	Enable the PA, PB, +DR, -DR inputs for Y axis	P9, 58
PEz	Terminal name	109	Enable the PA, PB, +DR, -DR inputs for Z axis	P9, 58
PFC0 to 1	Register bits	RSTS 18-19	Used as a status monitor for the PCMP5 pre-register.	P30, 50
PFM0 to 1	Register bits	RSTS 20-21	Used as a status monitor of the working pre-register.	P29, 50
PIM0 to 1	Register bits	RENV2 24-25	Specify the PA and PB input details	P39, 114
PINF	Register bit	RENV2 19	Apply a noise filter to the PA/PB inputs	P39, 114
PMD0 to 2	Register bits	RENV1 0-2	Specify the output pulse details	P36, 99
PMG0 to 4	Register bits	RENV6 27-31	Specify the multiplication rate for the PA/PB inputs.	P45, 58
PMSK	Register bit	RENV2 28	Specify the output pulse mask.	P39
POFF	Register bit	RENV2 31	Disable PA, PB inputs.	P39, 60
PRCI	Pre-register name		2nd pre-register for RCI	P28, 53
PRCP5	Pre-register name		2nd pre-register for RCMP5	P28, 47
PRDP	Pre-register name		2nd pre-register for RDP	P28, 32
PRDR	Pre-register name		2nd pre-register for RDR	P28, 32
PRDS	Pre-register name		2nd pre-register for RDS	P28, 35
PRECAN	Command	26h	Cancel the operation pre-register.	P24
PRESHF	Command	27h	Shift the data in the operation pre-register.	P24
PRFH	Pre-register name		2nd pre-register for RFH	P28, 31
PRFL	Pre-register name		2nd pre-register for RFL	P28, 31
PRIP	Pre-register name		2nd pre-register for RIP	P28, 35
PRMD	Pre-register name		2nd pre-register for RMD	P28, 33
PRMG	Pre-register name		2nd pre-register for RMG	P28, 32
PRMV	Pre-register name		2nd pre-register for RMV	P28, 31
PRSET	Command	4Fh	Put speed change data into the operation pre-register.	P24, 121
PRUR	Pre-register name		2nd pre-register for RUR	P28, 31
PRUS	Pre-register name		2nd pre-register for RUS	P28, 35
PSTP	Register bit	RENV6 15	Specify the stop method used for stopping when a PA/PB stop command is received	P45, 61
RCI	Register name		Circular interpolation step number data	P53, 81
RCIC	Register name		Circular interpolation step number counter	P53
RCMP1	Register name		Comparison data for comparator1	P46, 119
RCMP2	Register name		Comparison data for comparator2	P46, 119
RCMP3	Register name		Comparison data for comparator3	P47, 119

Label	Type	Position	Description	Reference
RCMP4	Register name		Comparison data for comparator4	P47, 119
RCMP5	Register name		Comparison data for comparator5	P47, 119
RCUN1	Register name		COUNTER1 (command position)	P46, 114
RCUN2	Register name		COUNTER2 (mechanical position)	P46, 114
RCUN3	Register name		COUNTER3 (deflection counter)	P46, 114
RCUN4	Register name		COUNTER4 (general-purpose counter)	P46, 114
RD	Terminal name	4	Lead signal	P7
RDP	Register name		Ramping-down point	P28, 32, 86
RDR	Register name		Deceleration rate	P26, 32, 86
RDS	Register name		S-curve range of deceleration	P28, 35, 86
RENV1	Register name		Environment setting register 1 (Specify the input/output terminals)	P28, 36
RENV2	Register name		Environment setting register 2 (Specify the details for the general-purpose port)	P28, 38
RENV3	Register name		Environment setting register 3 (Specify the details for a zero return or counter)	P28, 40
RENV4	Register name		Environment setting register 4 (Specify the details for comparators 1 to 4))	P28, 42
RENV5	Register name		Environment setting register 5 (Specify the detail for comparator 5)	P28, 44
RENV6	Register name		Environment setting register 6 (Specify the feed amount correction)	P28, 45
RENV7	Register name		Environment setting register 7 (Specify the vibration reduction function details)	P28, 45
REST	Register name		Error INT status	P51, 135
RFA	Register name		Speed for feeding the feed correction amount	P28, 35
RFH	Register name		Operation speed	P25, 28, 86
RFL	Register name		Initial speed	P28, 31, 86
RIP	Register name		Center position of a circular interpolation / Master axis feed amount when executing a linear interpolation using multiple LSI chips	P35, 80
RIPS	Command	FFh	Copy the RIPS register data to BUF	P26, 54
RIRQ	Register name		Enable various event interrupts	P28, 48, 135
RIST	Register name		Event INT status	P52, 135
RLTC1	Register name		COUNTER1 (command position) latch data	P48, 116
RLTC2	Register name		COUNTER2 (mechanical position) latch data	P48, 116
RLTC3	Register name		COUNTER3 (deflection counter) latch data	P49, 116
RLTC4	Register name		COUNTER4 (general-purpose) latch data	P49, 116
RMD	Register name		Operation mode	P28, 33
RMG	Register name		Speed magnification rate	P26, 32, 86
RMV	Register name		Feed amount or target position	P28, 31, 86
RPLS	Register name		Number of pulses remaining to be fed	P28, 52
RPRCI	Command	CCh	Copy PRCI data to BUF	P26
RPRCP5	Command	CBh	Copy PRCP5 data to BUF	P26
RPRDP	Command	C6h	Copy PRDP data to BUF	P26
RPRDR	Command	C4h	Copy PRDR data to BUF	P26
RPRDS	Command	CAh	Copy PRDS data to BUF	P26
RPRFH	Command	C2h	Copy PRFH data to BUF	P26
RPRFL	Command	C1h	Copy PRFL data to BUF	P26
RPRIP	Command	C8h	Copy PRIP data to BUF	P26
RPRMD	Command	C7h	Copy PRMD data to BUF	P26
RPRMG	Command	C5h	Copy PRMG data to BUF	P26
RPRMV	Command	C0h	Copy PRMV data to BUF	P26
RPRUR	Command	C3h	Copy PRUR data to BUF	P26
RPRUS	Command	C9h	Copy PRUS data to BUF	P26
RRCI	Command	FCh	Copy RCI data to BUF	P26
RRCIC	Command	FDh	Copy RCIC data to BUF	P26
RRCMP1	Command	E7h	Copy RCMP1 data to BUF	P26
RRCMP2	Command	E8h	Copy RCMP2 data to BUF	P26
RRCMP3	Command	E9h	Copy RCMP3 data to BUF	P26
RRCMP4	Command	EAh	Copy RCMP4 data to BUF	P26
RRCMP5	Command	EBh	Copy RCMP5 data to BUF	P26
RRCUN1	Command	E3h	Copy RCUN1 data to BUF	P26
RRCUN2	Command	E4h	Copy RCUN2 data to BUF	P26
RRCUN3	Command	E5h	Copy RCUN3 data to BUF	P26
RRCUN4	Command	E6h	Copy RCUN4 data to BUF	P26
RRDP	Command	D6h	Copy RDP data to BUF	P26
RRDR	Command	D4h	Copy RDR data to BUF	P26
RRDS	Command	DAh	Copy RDS data to BUF	P26
RRENV1	Command	DCh	Copy RENV1 data to BUF	P26
RRENV2	Command	DDh	Copy RENV2 data to BUF	P26
RRENV3	Command	DEh	Copy RENV3 data to BUF	P26
RRENV4	Command	DFh	Copy RENV4 data to BUF	P26
RRENV5	Command	E0h	Copy RENV5 data to BUF	P26
RRENV6	Command	E1h	Copy RENV6 data to BUF	P26
RRENV7	Command	E2h	Copy RENV7 data to BUF	P26
RREST	Command	F2h	Copy REST data to BUF	P26
RRFA	Command	DBh	Copy RFA data to BUF	P26
RRFH	Command	D2h	Copy RFH data to BUF	P26
RRFL	Command	D1h	Copy RFL data to BUF	P26

Label	Type	Position	Description	Reference
RRIP	Command	D8h	Copy RIP data to BUF	P26
RRIRQ	Command	ECh	Copy RIRQ data to BUF	P26
RRIST	Command	F3h	Copy RIST data to BUF	P26
RPIPS	Command	FFh		
RRLTC1	Command	EDh	Copy RLTC1 data to BUF	P26
RRLTC2	Command	EEh	Copy RLTC2 data to BUF	P26
RRLTC3	Command	EFh	Copy RLTC3 data to BUF	P26
RRLTC4	Command	F0h	Copy RLTC4 data to BUF	P26
RRMD	Command	D7h	Cop RMD data to BUF	P26
RRMG	Command	D5h	Copy RMG data to BUF	P26
RRMV	Command	D0h	Copy RMV data to BUF	P26
RRPLS	Command	F4h	Copy RPLS data to BUF	P26
RRSDC	Command	F6h	Copy RSDC data to BUF	P26
RRSPD	Command	F5h	Copy RSPD data to BUF	P26
RRSTS	Command	F1h	Copy RSTS data to BUF	P26
RRUR	Command	D3h	Copy RUR data to BUF	P26
RRUS	Command	D9h	Copy RUS data to BUF	P26
RSDC	Register name		Automatically calculated value for the ramping-down point	P28, 53
RSPD	Register name		EZ count / Monitor current speed	P28, 53
RST	Terminal name	175	Reset signal	P7, 97
RSTS	Register name		Extension status	P28, 50
RT0 to 15	Register bits	RENV7 0-15	Enter the RT time for the vibration reduction function	P45, 127
RUR	Register name		Acceleration rate	P28, 31, 86
RUS	Register name		S-curve range during acceleration	P28, 35, 86
SALM	Sub-status bit	SSTSW 11	Equals 1 when the ALM input is ON	P20, 109
SCLR	Register bit	RSTS 13	Equals 1 when the CLR input signal is ON	P50, 115
SCP1	Main status bit	MSTSW 8	Equals 1 when the CMP1 comparison conditions are met	P19, 120
SCP2	Main status bit	MSTSW 9	Equals 1 when the CMP2 comparison conditions are met	P19, 120
SCP3	Main status bit	MSTSW 10	Equals 1 when the CMP3 comparison conditions are met	P19, 120
SCP4	Main status bit	MSTSW 11	Equals 1 when the CMP4 comparison conditions are met	P19, 120
SCP5	Main status bit	MSTSW 12	Equals 1 when the CMP5 comparison conditions are met	P19, 120
SDIN	Register bit	RSTS 15	Equals 1 when the SD input signal is ON	P50, 104
SDIR	Register bit	RSTS 4	Set the operation direction (0: Plus direction, 1: Minus direction)	P50
SDL	Register bit	RENV1 6	Set the input logic of the SD signal (0: Negative logic, 1: Positive logic)	P36, 104
SDLT	Register bit	RENV1 5	Specify the latch function for the SD input (0: ON, 1: OFF)	P36, 104
SDM	Register bit	RENV1 4	Select the process to execute when the SD input is ON (0: Deceleration only, 1: Decelerate and stop)	P36, 104
SDM0 to 1	Register bits	RIPS 20-21	Current phase of a circular interpolation	P54
SDRM	Register bit	RSTS 12	Equals 1 when the -DR input signal is ON	P50, 63
SDRP	Register bit	RSTS 11	Equals 1 when the +DR input signal is ON	P50, 63
SDSTP	Command	4Ah	Deceleration stop	P22
SDu	Terminal name	132	Ramping-down signal for the U axis	P8, 102
SDx	Terminal name	36	Ramping-down signal for the X axis	P8, 102
SDy	Terminal name	68	Ramping-down signal for the Y axis	P8, 102
SDz	Terminal name	99	Ramping-down signal for the Z axis	P8, 102
SED0 to 1	Register bits	RIPS 22-23	Final phase of a circular interpolation	P54
SELu	Command bit name	COMW 11	Select the U axis	P18, 75
SELx	Command bit name	COMW 8	Select the X axis	P18, 75
SELy	Command bit name	COMW 9	Select the Y axis	P18, 75
SELz	Command bit name	COMW 10	Select the Z axis	P18, 75
SEMG	Register bit	RSTS 7	CEMG Input signal is ON	P50, 112
SEND	Main status bit	MSTSW 3	Equals 0 when started automatically, becomes 1 when stopped	P19
SENI	Main status bit	MSTSW 2	Equals 1 when an interrupt is caused by stopping.	P19, 135
SEOR	Main status bit	MSTSW 13	Equals 1 when unable to execute a position override.	P19, 98
SERC	Register bit	RSTS 9	Equals 1 when the ERC output signal is ON	P50, 108
SERR	Main status bit	MSTSW 3	Equals 1 when an error interrupt occurs	P19, 135
SEZ	Register bit	RSTS 10	Equals 1 when the EZ input signal is ON	P50, 76
SFC	Sub-status bit	SSTSW 10	Equals 1 when feeding at low speed	P20
SFD	Sub-status bit	SSTSW 9	Equals 1 when decelerating	P20
SFU	Sub-status bit	SSTSW 8	Equals 1 when accelerating	P20
SINP	Register bit	RSTS 16	Equals 1 when the INP input signal is ON	P50, 106
SINT	Main status bit	MSTSW 4	Equals 1 when an event interrupt occurs	P19, 135
SLTC	Register bit	RSTS 14	Equals 1 when the LTC input signal is ON	P50, 116
SMAX	Register bit	RENV2 29	Select the PCL6045B mode for the "start when the specified axis stops" function.	P39, 128
SMEL	Sub-status bit	SSTSW 13	Equals 1 when the nEL input is ON	P20, 102
SORG	Sub-status bit	SSTSW 14	Equals 1 when the ORG input is ON	P20, 105
SPCS	Register bit	RSTS 8	Equals 1 when the PCS input signal is ON	P50, 110
SPDF	Main status bit	MSTSW 15	Equals 1 when the pre-register for comparator 5 is full	P19, 30
SPEL	Sub-status bit	SSTSW 12	Equals 1 when the +EL input is ON	P20, 102
SPRF	Main status bit	MSTSW 14	Equals 1 when the next-operation pre-register is full	P19, 29

Label	Type	Position	Description	Reference
SPSTA	Command	2Ah	The same process as the CSTA input	P22
SRST	Command	04h	Software reset	P24
SRUN	Main status bit	MSTSW 0	Equals 1 while starting	P19
SSC0 to 1	Main status bits	MSTSW 7-6	Sequence code	P19
SSCM	Main status bit	MSTSW 0	Equals 1 when a start command has already been written	P19
SSD	Sub-status bit	SSTSW 15	Equals 1 when the SD input is ON (latched signal)	P20, 104
SSTA	Register bit	RSTS 5	Equals 1 when the CSTA input signal is ON	P50, 110
SSTP	Register bit	RSTS 6	Equals 1 when the CSTP input signal is ON	P50, 112
SSTSB	Byte map name	3 when using a Z80	Used to read the sub status	P16, 20
SSTSW	Word map name	2 when using an 8086	Used to read the sub status, general input/output port	P17, 20
STAD	Command	52h	High speed start 1 (FH low speed -> deceleration stop)	P21
STAFH	Command	51h	Start using FH low speed	P21
STAFL	Command	50h	Start using FL low speed	P21
STAM	Register bit	RENV1 18	Select CSTA signal input specification (0: Level trigger, 1: Edge trigger)	P36, 110
STAON	Command	28h	Substitute for a PCs input	P24, 98
STAUD	Command	53h	High speed start 2 (acceleration -> FH low speed -> deceleration stop)	P21
STOP	Command	49h	Immediate stop	P22
STPM	Register bit	RENV1 19	Select CSTP stop method (0: Immediate stop, 1: Deceleration stop)	P36, 112
SYI0 to 1	Register bits	RENV5 20-21	Select the axis used to input an internal synchronous signal	P44, 128
SYO0 to 3	Register bits	RENV5 16-19	Set the output timing of the internal synchronous signal	P44, 128
WPRCI	Command	8Ch	Write BUF data into PRCI	P26
WPRCP5	Command	8Bh	Write BUF data into PRCP5	P26
WPRDP	Command	86h	Write BUF data into PRDP	P26
WPRDR	Command	84h	Write BUF data into PRDR	P26
WPRDS	Command	8Ah	Write BUF data into PRDS	P26
WPRFH	Command	82h	Write BUF data into PRFH	P26
WPRFL	Command	81h	Write BUF data into PRFL	P26
WPRIP	Command	88h	Write BUF data into PRIP	P26
WPRMD	Command	87h	Write BUF data into PRMD	P26
WPRMG	Command	85h	Write BUF data into PRMG	P26
WPRMV	Command	80h	Write BUF data into PRMV	P26
WPRUR	Command	83h	Write BUF data into PRUR	P26
WPRUS	Command	89h	Write BUF data into PRUS	P26
WR	Terminal name	5	Write signal	P7
WRCI	Command	BCh	Write BUF data into the RCI register	P26
WRCMP1	Command	A7h	Write BUF data into the RCMP1 register	P26
WRCMP2	Command	A8h	Write BUF data into the RCMP2 register	P26
WRCMP3	Command	A9h	Write BUF data into the RCMP3 register	P26
WRCMP4	Command	AAh	Write BUF data into the RCMP4 register	P26
WRCMP5	Command	ABh	Write BUF data into the RCMP5 register	P26
WRCUN1	Command	A3h	Write BUF data into the RCUN1 register	P26
WRCUN2	Command	A4h	Write BUF data into the RCUN2 register	P26
WRCUN3	Command	A5h	Write BUF data into the RCUN3 register	P26
WRCUN4	Command	A6h	Write BUF data into the RCUN4 register	P26
WRDP	Command	96h	Write BUF data into the RDP register	P26
WRDR	Command	94h	Write BUF data into the RDR register	P26
WRDS	Command	9Ah	Write BUF data into the RDS register	P26
WRENV1	Command	9Ch	Write BUF data into the RENV1 register	P26
WRENV2	Command	9Dh	Write BUF data into the RENV2 register	P26
WRENV3	Command	9Eh	Write BUF data into the RENV3 register	P26
WRENV4	Command	9Fh	Write BUF data into the RENV4 register	P26
WRENV5	Command	A0h	Write BUF data into the RENV5 register	P26
WRENV6	Command	A1h	Write BUF data into the RENV6 register	P26
WRENV7	Command	A2h	Write BUF data into the RENV7 register	P26
WRFA	Command	9Bh	Write BUF data into the RFA register	P26
WRFH	Command	92h	Write BUF data into the RFH register	P26
WRFL	Command	91h	Write BUF data into the RFL register	P26
WRIP	Command	98h	Write BUF data into the RIP register	P26
WRIRQ	Command	ACH	Write BUF data into the RIRQ register	P26
WRMD	Command	97h	Write BUF data into the RMD register	P26
WRMG	Command	95h	Write BUF data into the RMG register	P26
WRMV	Command	90h	Write BUF data into the RMV register	P26
WRQ	Terminal name	13	Wait request signal	P8
WRUR	Command	93h	Write BUF data into the RUR register	P26
WRUS	Command	99h	Write BUF data into the RUS register	P26

Appendix-4. Differences between the PCL6045 and PCL6045B

The PCL6045B is a functionally upgraded version of the PCL6045.
This section describes items that have been added to the PCL6045B.

1. How to identify the PCL6045 and PCL6045B

Some registers have been added and they can be checked to identify the PCL6045 version.

- 1) Enter any number (1 to 2,147,483,647) into the input/output buffer.
- 2) Write a WRCl command (BCh). (Input/output buffer -> RCl register)
- 3) Write a "0" in order to clear the input/output buffer.
- 4) Write an RRCl command (FCh). (Input/output buffer <- RCl register)
- 5) Read the input/output buffer. If the data read is 0, this is a PCL6045. If the data read is the value entered in step 1) above, this is a PCL6045B.

Note: Since the U axis does not have an RCl register, do not use the U axis for the check described above.

2. Additional items on the PCL6045B

2-1. Main status

Added bit 2 (SENI) and bit 13 (SEOR)

15	14	13	12	11	10	9	8	7	6	5	4	3	2	1	0
SPDF	SPRF	SEOR	SCP5	SCP4	SCP3	SCP2	SCP1	SSC1	SSC0	SINT	SERR	SEND	SENI	SRUN	SSCM

Bit	Bit name	Detail
2	SENI	Stop interrupt flag When IEND = 1 in the RENV2 register, a change from operating to stopped will make this bit be "1." (By reading main status, it returns to "0.")
13	SEOR	This bit becomes "1" when the PCL cannot execute a position override. (When the main status is read, it returns to "0.")

2-2. Operation command

The following command has been added.

COMB0	Symbol	Detail
4Fh	PRSET	Pre-register set command.

2-3. Register control command

The following five commands have been added.

No.	Regi-ster	Details	Read command		Write command		2nd pre-register	Read command		Write command	
			COMB0	Symbol	COMB0	Symbol		COMB0	Symbol	COMB0	Symbol
	RCI	Circular interpolation step number	FCh	RRCI	BCh	WRCl	PRCl	CCh	RPRCl	8Ch	WPRCl
	RICI	Circular interpolation step counter	FDh	RRCIC							

2-4. PRMD (RMD) register

Bit 7 (MENI) and operation mode (MOD) details have been added.

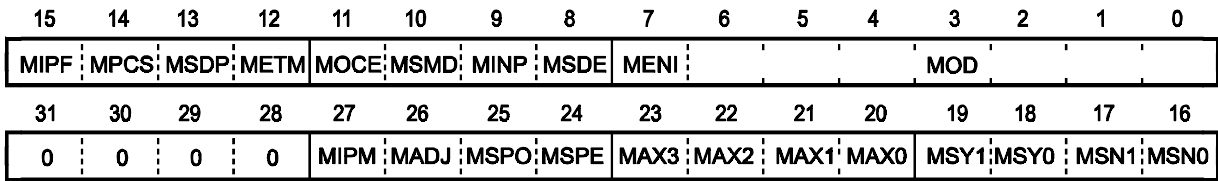

Bit	Bit name	Detail
0 to 6	MOD	The following operation modes have been added. 100 0010 (42h): Positioning operation (specify an absolute position in COUNTER1) 100 0011 (43h): Positioning operation (specify an absolute position in COUNTER2) 100 0010 (52h): Positioning operation synchronized with PA/PB (specify an absolute position in COUNTER1) 100 0011 (53h): Positioning operation synchronized with PA/PB (specify an absolute position in COUNTER2) 110 0110 (66h): CW circular interpolation synchronized with the U axis (arc linear interpolation) 110 0111 (67h): CW circular interpolation synchronized with the U axis (arc linear interpolation) 110 1000 (68h): Continuous linear interpolation 1 synchronized with PA/PB 110 1001 (69h): Linear interpolation 1 synchronized with PA/PB 110 1010 (6Ah): Continuous linear interpolation 2 synchronized with PA/PB 110 0011 (6Bh): Linear interpolation 2 synchronized with PA/PB 110 1100 (6Ch): CW circular interpolation synchronized with PA/PB 110 1101 (6Dh): CCW circular interpolation operation synchronized with PA/PB
7	MENI	1: When a pre-register is already set, the PCL will not output an INT signal, even if IEND is changed to "1."

2-5. RENV2 register

Bits 18 & 19 and 27 to 31 have been added.

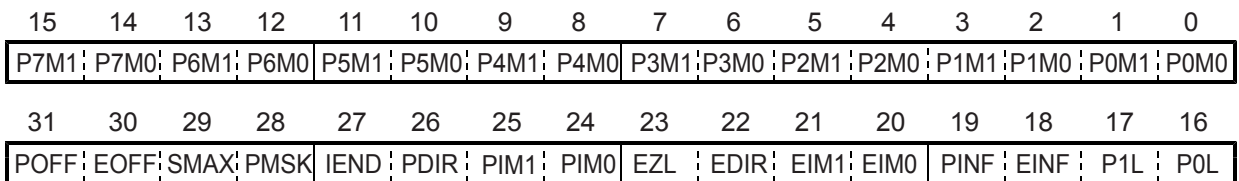

Bit	Bit name	Detail
18	EINF	1: Apply a noise filter to the EA/EB/EZ inputs.
19	PINF	1: Apply a noise filter to the PA/PB inputs.
27	IEND	Regardless of whether a normal or emergency stop occurs, the PCL will output an INT signal when stopped.
28	PMSK	Masks output pulses.
29	SMAX	1: Enables the currently working axis to be specified for the "start when the specified axis stops" function.
30	EOFF	1: Disables EA/EB inputs.
31	POFF	1: Disables PA/PB inputs.

2-6. RENV4 register

Bit 7 (C1RM), bit 15 (C2RM) and bit 23 (IDXN) have been added.

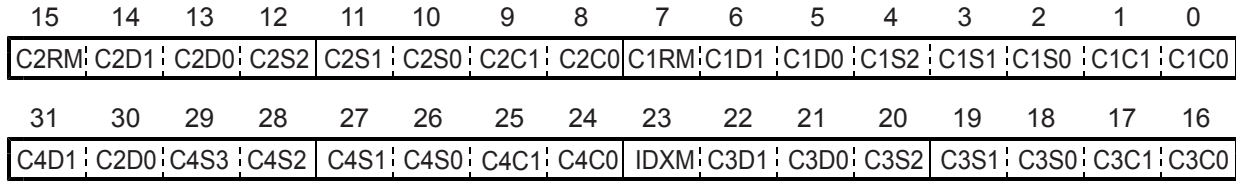

Bit	Bit name	Detail
7	C1RM	1: Sets COUNTER1 for ring counter operation using Comparator 1.
15	C2RM	1: Sets COUNTER2 for ring counter operation using Comparator 2.
23	IDXN	0: Output an IDX signal while COUNTER4 = RCMP2. 1: When COUNTER4 becomes "0" by counting down, the PCL will output an IDX signal for two CLK cycles. (This is only valid when C4S0 to C4S3 are set to 1000, 1001 or 1010.)

2-7. RENV5 register

Bits 24 (CU1L) to bit 27 (CU4L) have been added.

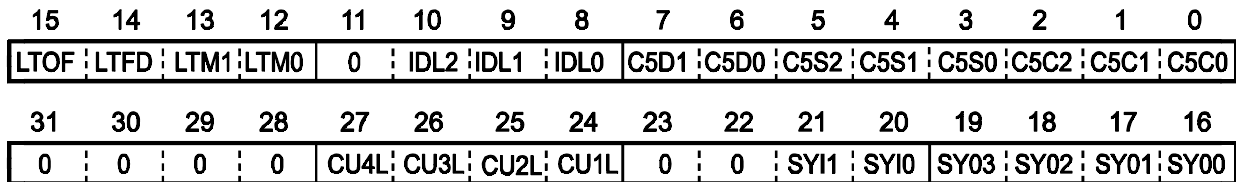

Bit	Bit name	Details
24	CU1L	1: The PCL clears COUNTER1 at the same time it latches COUNTER1.
25	CU2L	1: The PCL clears COUNTER2 at the same time it latches COUNTER2.
26	CU3L	1: The PCL clears COUNTER3 at the same time it latches COUNTER3.
27	CU4L	1: The PCL clears COUNTER4 at the same time it latches COUNTER4.

2-8. RENV6 register

Bit 15 (PSTP), bits 16 to 26 (BD0 to 10), and bits 27 to 31 (REG0 to 4) have been added.

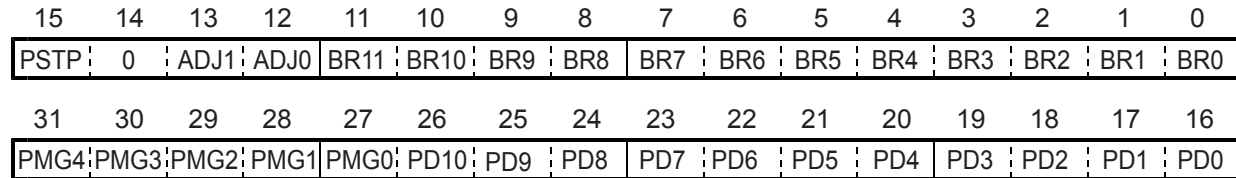

Bit	Bit name	Detail
15	PSTP	1: Even when a stop command is written, the pulses already input on PA/PB will be fed.
16 to 26	PD0 to 10	Set the PA/PB division rate [Divide by (set value / 2048)]
27 to 31	PMG0 to 4	Set the PA/PB multiplication rate [enter (multiplication value - 1)]

2-9. RSTS register

Bits 18 & 19 (PFC0 to 1) and bits 20 & 21 (PFM0 to 1) have been added.

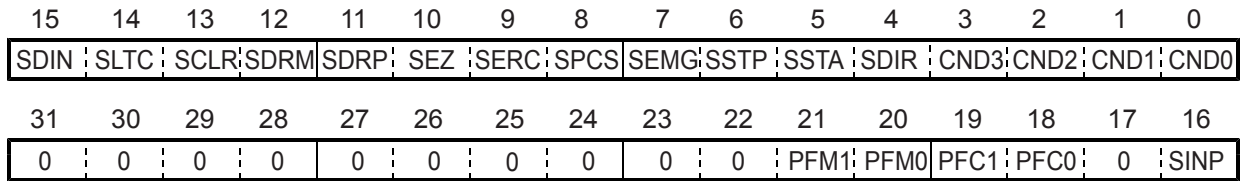

Bit	Bit name	Detail
18 to 19	PFC0 to 1	Monitors the use conditions of the RCMP5 pre-register.
20 to 21	PFM0 to 1	Monitors the use conditions of the operation pre-registers (other than RCMP5).

2-10. PRCI (RCI) register

A data register to hold the circular interpolation step number has been added. (This is not available for the U axis.)

RCI is the register for PRCI.

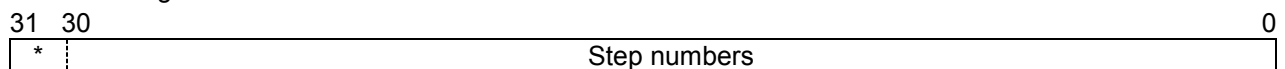

Bits with an asterisk "*" will be ignored when written, and become "0" when read.

2-11. RCIC register

A register to read the circular interpolation step count value has been added. (Read only)

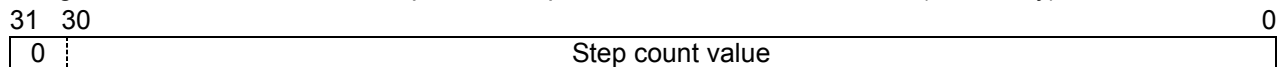

2-12. Stop in the middle of a circular interpolation

The PCL6045 cannot resume the remainder of a circular interpolation when stopped in the middle of the operation.

The PCL6045B can continue the operation using the Residual Amount Start command (54h to 57h).

2-13. Improved precision for the FH correction calculation

The PCL6045B has improved FH correction calculation precision, compared to the PCL6045.

Therefore, for small feed amount positioning operations, the speed curve may change.

2-14. Change the start timing to count down using EZ during a zero return operation

1) When ORM = 0100, 0101, or 1011, the PCL will reverse direction when the ORG input turns ON, and it will stop moving backward when EZ starts counting up.

Although the PCL6045 starts counting pulses on the EZ terminal at the same time it reverses direction, the PCL6045B will start counting EZ pulses after the ORG input changes from ON to OFF.

2) When ORM = 0111, 1000, or 1100, the PCL will reverse direction when the EL input turns ON, and it will stop moving backward when EZ starts counting up.

Although the PCL6045 starts counting pulses on the EZ terminal at the same time it reverses direction, the PCL6045B will start counting EZ pulses after the EL input changes from ON to OFF.

2-15. Correct the acceleration speed when the synthesized speed is constant

When the synthesized speed is constant (MPIF = 1) and an auto ramp down point is specified (MSDP = 0), if you want to execute linear interpolation 1 or a circular interpolation with acceleration/deceleration, set PRDP to "-1." (When using the PCL6045, leave PRDP = 0.)

[Handling Precautions]

1. Design precautions

- 1) Never exceed the absolute maximum ratings, even for a very short time.
- 2) Take precautions against the influence of heat in the environment, and keep the temperature around the LSI as cool as possible.
- 3) Please note that ignoring the following may result in latching up and may cause overheating and smoke.
 - Do not apply a voltage greater than the specified voltages for the Vdd5 terminal to the input/output terminals and do not pull them below GND.
 - Please consider the voltage drop timing when turning the power ON/OFF. Consider power voltage drop timing when turning ON/OFF the power.
 - Make sure you consider the input timing when power is applied.
 - Be careful not to introduce external noise into the LSI.
 - Hold the unused input terminals to +5 V or GND level.
 - Do not short-circuit the outputs.
 - Protect the LSI from inductive pulses caused by electrical sources that generate large voltage surges, and take appropriate precautions against static electricity.
- 4) Provide external circuit protection components so that overvoltages caused by noise, voltage surges, or static electricity are not fed to the LSI.
- 5) Turn the Vdd5 (+5V) and Vdd3 (+3.3V) supply ON/OFF at the same time, or as nearly the same time as possible. Turning the power on to either voltage supply may cause a "break-through current" to flow. Continued application of a "break-through current" may generate heat and shorten the life of the LSIs.

2. Precautions for transporting and storing LSIs

- 1) Always handle LSIs carefully and keep them in their packages. Throwing or dropping LSIs may damage them.
- 2) Do not store LSIs in a location exposed to water droplets or direct sunlight.
- 3) Do not store the LSI in a location where corrosive gases are present, or in excessively dusty environments.
- 4) Store the LSIs in an anti-static storage container, and make sure that no physical load is placed on the LSIs.

3. Precautions for installation

- 1) In order to prevent damage caused by static electricity, pay attention to the following.
 - Make sure to ground all equipment, tools, and jigs that are present at the work site.
 - Ground the work desk surface using a conductive mat or similar apparatus (with an appropriate resistance factor). However, do not allow work on a metal surface, which can cause a rapid change in the electrical charge on the LSI (if the charged LSI touches the surface directly) due to extremely low resistance.
 - When picking up an LSI using a vacuum device, provide anti-static protection using a conductive rubber pick up tip. Anything which contacts the leads should have as high a resistance as possible.
 - When using a pincer that may make contact with the LSI terminals, use an anti-static model. Do not use a metal pincer, if possible.
 - Store unused LSIs in a PC board storage box that is protected against static electricity, and make sure there is adequate clearance between the LSIs. Never directly stack them on each other, as it may cause friction that can develop an electrical charge.
- 2) Operators must wear wrist straps which are grounded through approximately 1M-ohm of resistance.
- 3) Use low voltage soldering devices and make sure the tips are grounded.
- 4) Do not store or use LSIs, or a container filled with LSIs, near high-voltage electrical fields, such those produced by a CRT.
- 5) To preheat LSIs for soldering, we recommend keeping them at a high temperature in a completely dry environment, i.e. 125°C for 24 hours. The LSI must not be exposed to heat more than 2 times.

6) When using an infrared reflow system to apply solder, we recommend the use of a far-infrared pre-heater and mid-infrared reflow devices, in order to ease the thermal stress on the LSIs.

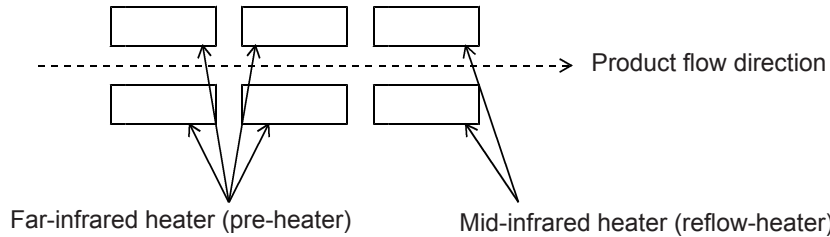

Package and substrate surface temperatures must never exceed 240°C and they must not exceed 210°C for more than 30 seconds. The temperature change when cooling after a solder reflow process must be less than 3°C per second.

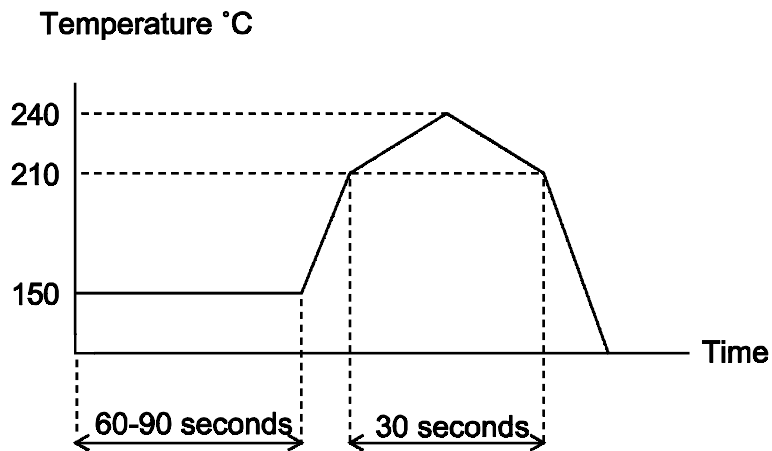

7) When using hot air for solder reflow, the restrictions are the same as for infrared reflow equipment.

8) When using vapor phase solder, use Fluorinate FC-70 solvent, or its equivalent. The ambient temperature must not exceed 215°C for more than 30 seconds and it must not exceed 200°C for more than 60 seconds.

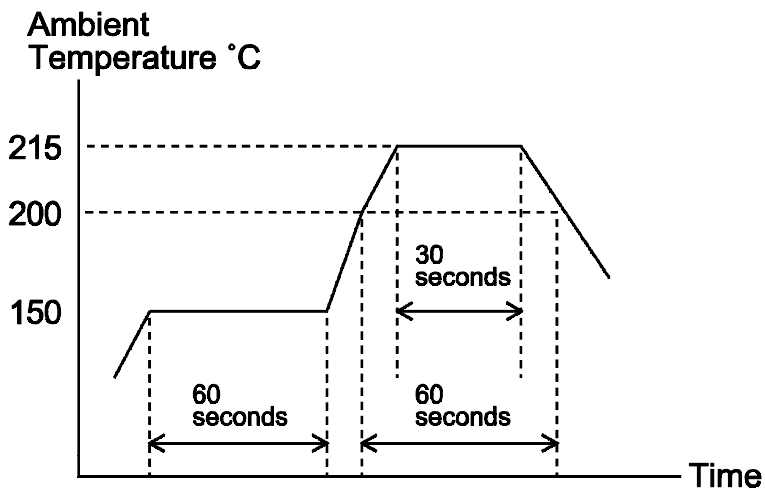

9) When using a solder iron, the lead section temperature must not exceed 260°C for more than 10 seconds or 350°C for more than 3 seconds.

4. Other precautions

- 1) When the LSI will be used in poor environments (high humidity, corrosive gases, or excessive amounts of dust), we recommend applying a moisture prevention coating.
- 2) The package resin is made of fire-retardant material; however, it can burn. When baked or burned, it may generate gases or fire. Do not use it near ignition sources or flammable objects.
- 3) This LSI is designed for use in commercial apparatus (office machines, communication equipment, measuring equipment, and household appliances). If you use it in any device that may require high quality and reliability, or where faults or malfunctions may directly affect human survival or injure humans, such as in nuclear power control devices, aviation devices or spacecraft, traffic signals, fire control, or various types of safety devices, we will not be liable for any problem that occurs, even if it was directly caused by the LSI. Customers must provide their own safety measures to ensure appropriate performance in all circumstances.

NPM NIPPON PULSE MOTOR CO., LTD.

Tokyo Office: No. 16-13, 2-chome, Hongo, Bunkyo-ku, Tokyo 113-0033, Japan
Phone: 81-3-3813-8841 Fax: 81-3-3813-7049
E-mail: device@npm.co.jp <http://www.pulsemotor.com>
U.S. Office: 1073 East Main Street, Radford, VA 24141, U.S.A.
Phone: 1-540-633-1677 Fax: 1-540-633-1674
E-mail: info@nipponpulse.com <http://www.nipponpulse.com>

MNAL. No. PCL-6045B-1 1B-5205-0.5 (5205) ims