

PCM1744

For most current data sheet and other product information, visit www.burr-brown.com

Sound^{PLUS}™ 24 Bits, 96kHz, Sampling Stereo Audio DIGITAL-TO-ANALOG CONVERTER

FEATURES

- COMPLETE STEREO DAC: Includes Digital Filter and Output Amp
- DYNAMIC RANGE: 95dB
- MULTIPLE SAMPLING FREQUENCIES: Up to 96kHz
- 8x OVERSAMPLING DIGITAL FILTER
- SYSTEM CLOCK: $256f_s/384f_s$
- 24-BIT I²S DATA INPUT FORMAT
- SMALL 14-PIN SOIC PACKAGE

DESCRIPTION

The PCM1744 is a complete low cost stereo audio digital-to-analog converter (DAC), operating off of a $256f_s$ or $384f_s$ system clock. The DAC contains a 3rd-order $\Delta\Sigma$ modulator, a digital interpolation filter, and an analog output amplifier. The PCM1744 accepts 24-bit input data in a I²S format.

The digital filter performs an 8x interpolation function and includes de-emphasis at 44.1kHz. The PCM1744 can accept digital audio sampling frequencies from 16kHz to 96kHz, always at 8X oversampling.

The PCM1744 is ideal for low-cost, CD-quality consumer audio applications.

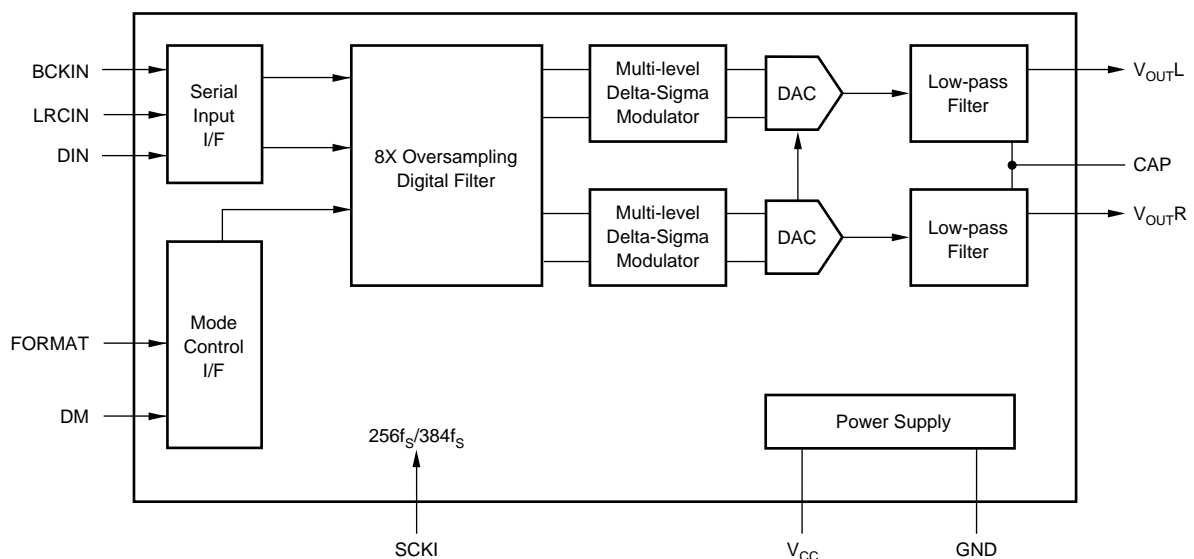

International Airport Industrial Park • Mailing Address: PO Box 11400, Tucson, AZ 85734 • Street Address: 6730 S. Tucson Blvd., Tucson, AZ 85706 • Tel: (520) 746-1111 • Twx: 910-952-1111
Internet: <http://www.burr-brown.com/> • FAXLine: (800) 548-6133 (US/Canada Only) • Cable: BBRCORP • Telex: 066-6491 • FAX: (520) 889-1510 • Immediate Product Info: (800) 548-6132

SPECIFICATIONS

All specifications at +25°C, +V_{CC} = +5V, f_s = 44.1kHz, and 18-bit input data, SYSCLK = 384f_s, unless otherwise noted.

PARAMETER	CONDITIONS	PCM1744			UNITS
		MIN	TYP	MAX	
RESOLUTION		24			Bits
DATA FORMAT Audio Data Interface Format Audio Data Format Sampling Frequency (f _s) Internal System Clock Frequency		16	I ² S Two's Binary Complement 256f _s /384f _s	96	kHz
DIGITAL INPUT/OUTPUT Logic Level Input Logic Level V _{IH} (¹) V _{IL} (¹) Input Logic Current: I _N (¹)		2.0	TTL	0.8 ±0.8	VDC VDC µA
DYNAMIC PERFORMANCE (²) THD+N at FS (0dB) THD+N at -60dB Dynamic Range Signal-to-Noise Ratio Channel Separation	f = 991kHz EIAJ, A-weighted EIAJ, A-weighted	90 90 88	-83 -32 95 97 95	-79	dB dB dB dB dB
DC ACCURACY Gain Error Gain Mismatch, Channel-to-Channel Bipolar Zero Error	V _{OUT} = V _{CC} /2 at BPZ		±1.0 ±1.0 ±20	±10.0 ±5.0 ±50	% of FSR % of FSR mV
ANALOG OUTPUT Output Voltage Center Voltage Load Impedance	Full Scale (0dB) AC Load	10	0.62 × V _{CC} V _{CC} /2		Vp-p VDC kΩ
DIGITAL FILTER PERFORMANCE Passband Stopband Passband Ripple Stopband Attenuation Delay Time		0.555 -35	11.125/f _s	0.445 ±0.17	f _s f _s dB dB sec
INTERNAL ANALOG FILTER -3dB Bandwidth Passband Response	f = 20kHz		100 -0.16		kHz dB
POWER SUPPLY REQUIREMENTS Voltage Range Supply Current Power Dissipation		4.5	5 13 65	5.5 18 90	VDC mA mW
TEMPERATURE RANGE Operation Storage		-25 -55		+85 +125	°C °C

NOTES: (1) Pins 1, 2, 3, 12, 13, 14: LRCIN, DIN, BCKIN, DM, FORMAT, SCKI. (2) Dynamic performance specs are tested with 20kHz low pass filter and THD+N specs are tested with 30kHz LPF, 400Hz HPF, Average-Mode.

The information provided herein is believed to be reliable; however, BURR-BROWN assumes no responsibility for inaccuracies or omissions. BURR-BROWN assumes no responsibility for the use of this information, and all use of such information shall be entirely at the user's own risk. Prices and specifications are subject to change without notice. No patent rights or licenses to any of the circuits described herein are implied or granted to any third party. BURR-BROWN does not authorize or warrant any BURR-BROWN product for use in life support devices and/or systems.

PIN CONFIGURATION

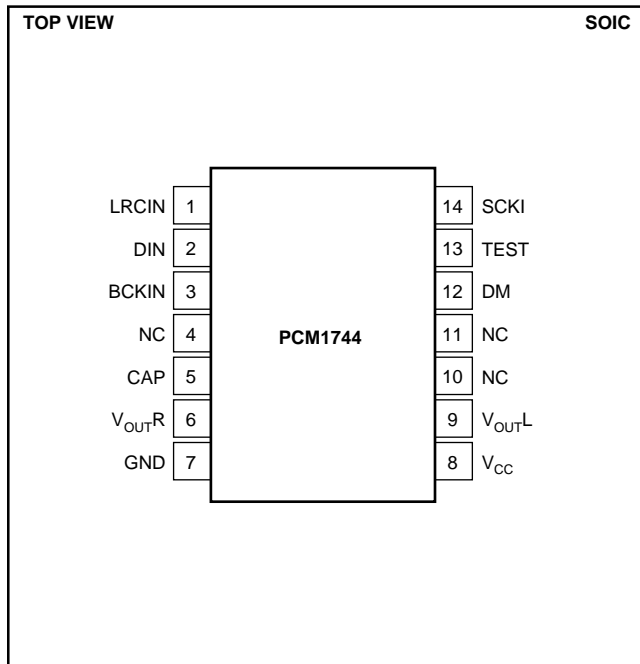

PIN ASSIGNMENTS

PIN	NAME	I/O	FUNCTION
1 ⁽¹⁾	LRCIN	IN	Sample Rate Clock Input
2 ⁽¹⁾	DIN	IN	Audio Data Input
3 ⁽¹⁾	BCKIN	IN	Bit Clock Input for Audio Data.
4	NC	—	No Connection
5	CAP	—	Common Pin of Analog Output Amp
6	V _{OUTR}	OUT	Right-Channel Analog Output
7	GND	—	Ground
8	V _{CC}	—	Power Supply
9	V _{OUTL}	OUT	Left-Channel Analog Output
10	NC	—	No Connection
11	NC	—	No Connection
12 ⁽²⁾	DM	IN	De-Emphasis Control HIGH: De-emphasis ON LOW: De-emphasis OFF
13 ⁽²⁾	TEST	—	Test Pin. Must be left open.
14 ⁽¹⁾	SCKI	IN	System Clock Input (256f _s or 384f _s)

NOTE: (1) Schmitt-Trigger input. (2) Schmitt-Trigger input with internal pull-up.

ABSOLUTE MAXIMUM RATINGS

Power Supply Voltage	+6.5V
+V _{CC} to +V _{DD} Difference	±0.1V
Input Logic Voltage	−0.3V to (V _{DD} + 0.3V)
Power Dissipation	290mW
Operating Temperature Range	−25°C to +85°C
Storage Temperature	−55°C to +125°C
Lead Temperature (soldering, 5s)	+260°C
Thermal Resistance, θ_{JA}	+90°C/W



ELECTROSTATIC DISCHARGE SENSITIVITY

This integrated circuit can be damaged by ESD. Burr-Brown recommends that all integrated circuits be handled with appropriate precautions. Failure to observe proper handling and installation procedures can cause damage.

ESD damage can range from subtle performance degradation to complete device failure. Precision integrated circuits may be more susceptible to damage because very small parametric changes could cause the device not to meet its published specifications.

PACKAGE/ORDERING INFORMATION

PRODUCT	PACKAGE	PACKAGE DRAWING NUMBER ⁽¹⁾	SPECIFIED TEMPERATURE RANGE	PACKAGE MARKING	ORDERING NUMBER ⁽²⁾	TRANSPORT MEDIA
PCM1744	SO-14	235	−25°C to +85°C	PCM1744U PCM1744U	PCM1744U PCM1744U/2K	Rails Tape and Reel

NOTES: (1) For detailed drawing and dimension table, please see end of data sheet, or Appendix C of Burr-Brown IC Data Book, or visit the Burr-Brown web site at www.burr-brown.com. (2) Models with a slash (/) are available only in Tape and Reel in the quantities indicated (e.g., /2K indicates 2000 devices per reel). Ordering 2000 pieces of "PCM1744U/2K" will get a single 2500-piece Tape and Reel. For detailed Tape and Reel mechanical information, refer to Appendix B of Burr-Brown IC Data Book.

TYPICAL PERFORMANCE CURVES

At $T_A = +25^\circ\text{C}$, $V_{CC} = +5\text{V}$, $f_s = 44.1\text{kHz}$, $\text{SYSCLK} = 256f_s$, unless otherwise noted.

DYNAMIC PERFORMANCE

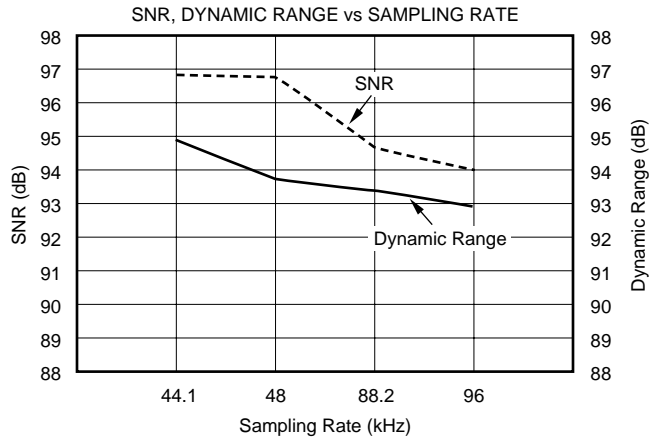
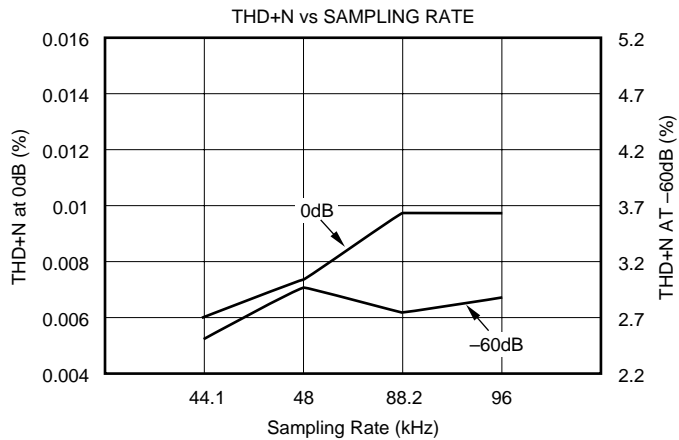
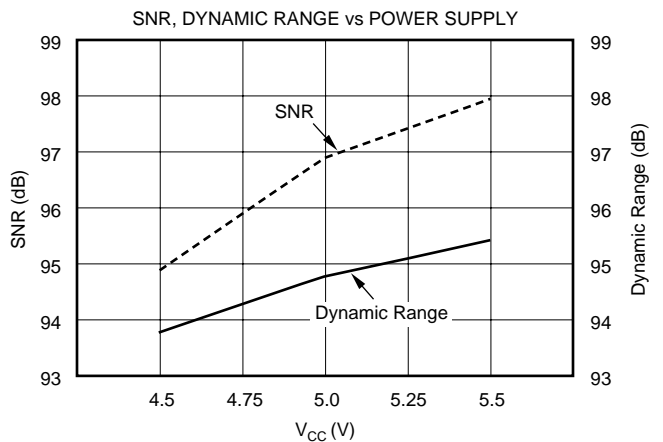
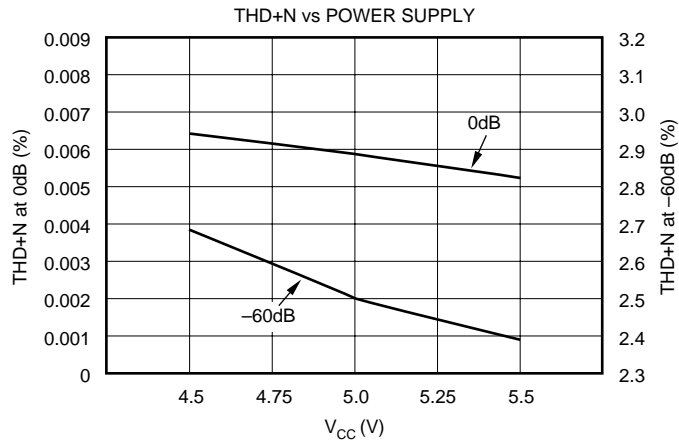
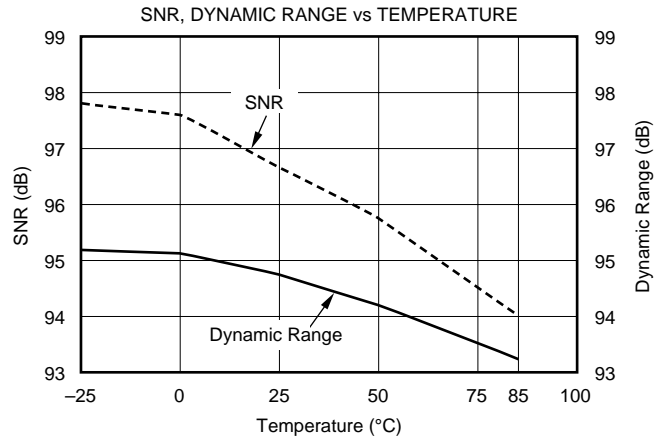
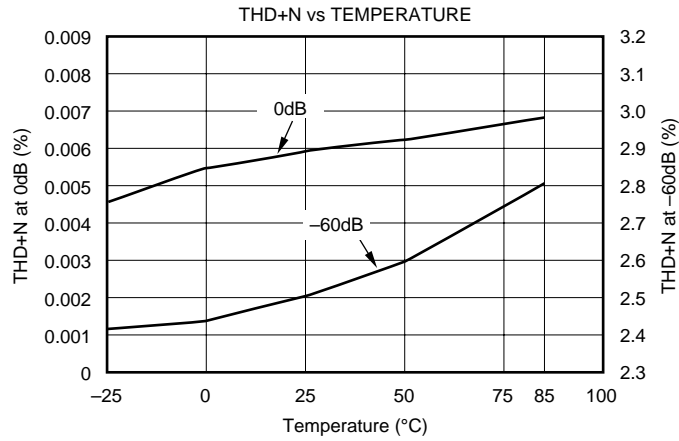

TYPICAL PERFORMANCE CURVES

At $T_A = +25^\circ\text{C}$, $+V_{CC} = +V_{DD} = +5\text{V}$, $f_S = 44.1\text{kHz}$, and 18-bit input data, $\text{SYSCLK} = 384f_S$, unless otherwise noted.

DIGITAL FILTER

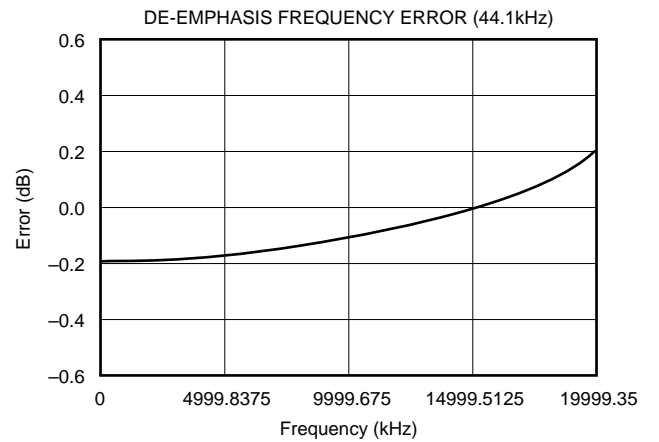
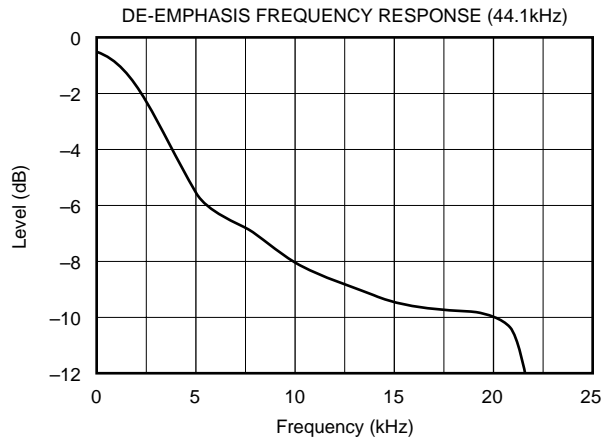
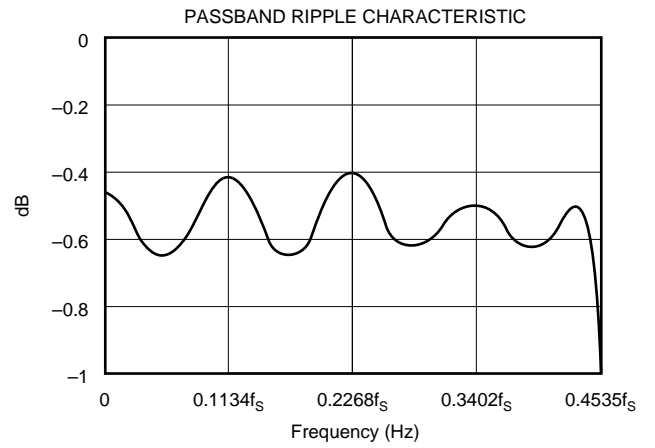
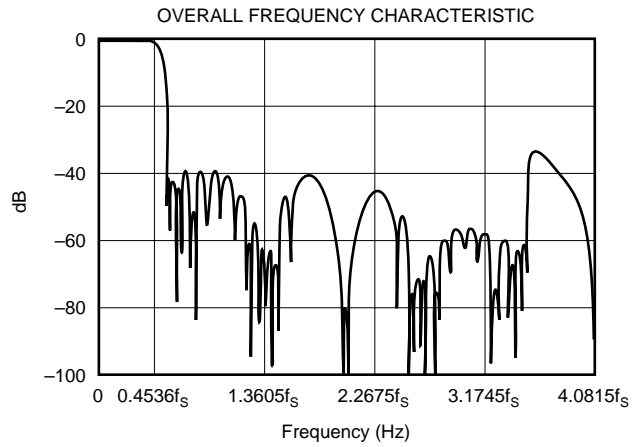

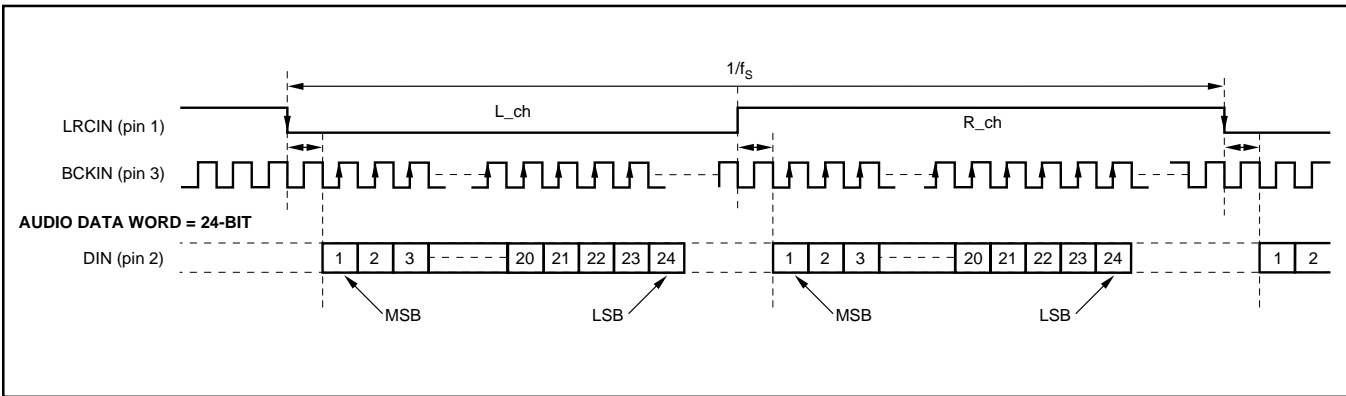

FIGURE 1. I²S Data Input Timing.

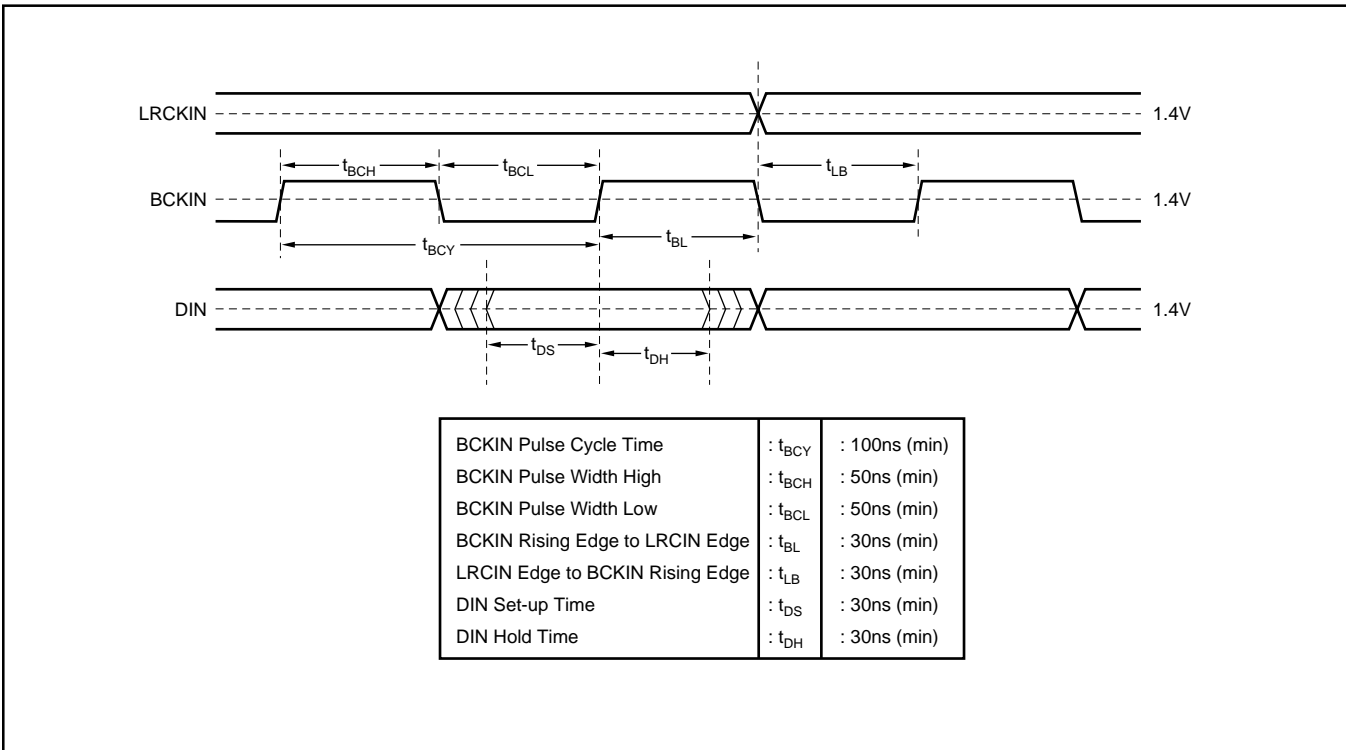

FIGURE 2. Audio Data Input Timing.

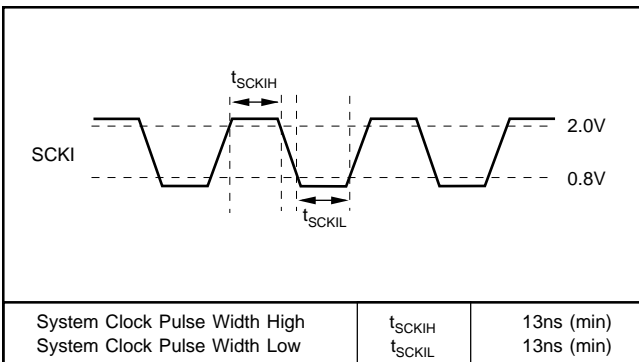

FIGURE 3. System Clock Timing Requirements.

SYSTEM CLOCK

The system clock for PCM1744 must be either $256f_s$ or $384f_s$, where f_s is the audio sampling frequency (LRCIN), typically 32kHz, 44.1kHz, 48kHz, 88.2kHz or 96kHz. The system clock is used to operate the digital filter and the noise shaper. The system clock input (SCKI) is at pin 14. Timing conditions for SCKI are shown in Figure 3.

PCM1744 has a system clock detection circuit which automatically detects the frequency, either $256f_s$ or $384f_s$. The system clock should be synchronized with LRCIN (pin 1), but PCM1744 can compensate for phase differences. If the phase difference between LRCIN and system clock is greater

than ± 6 bit clocks (BCKIN), the synchronization is performed automatically. The analog outputs are forced to a bipolar zero state ($V_{CC}/2$) during the synchronization function. Table I shows the typical system clock frequency inputs for the PCM1744.

SAMPLING RATE (LRCIN)	SYSTEM CLOCK FREQUENCY (MHz)	
	$256f_s$	$384f_s$
32kHz	8.192	12.288
44.1kHz	11.2896	16.9340
48kHz	12.288	18.432
88.2kHz	22.5792	33.868
96kHz	24.576	36.864

TABLE I. System Clock Frequencies vs Sampling Rate.

TYPICAL CONNECTION DIAGRAM

Figure 4 illustrates the typical connection diagram for PCM1744 used in a stand-alone application.

INPUT DATA FORMAT

PCM1744 can accept input data a 24-bit I²S format, as shown in Figure 1.

RESET

PCM1744 has an internal power-on reset circuit. The internal power-on reset initializes (resets) when the supply voltage $V_{CC} > 2.2V$ (typ). The power-on reset has an initialization period equal to 1024 system clock periods after $V_{CC} > 2.2V$. During the initialization period, the outputs of the DAC are invalid, and the analog outputs are forced to $V_{CC}/2$. Figure 5 illustrates the power-on reset and reset-pin reset timing.

DE-EMPHASIS CONTROL

Pin 12 (DM) enables PCM1744's de-emphasis function. De-emphasis operates only at 44.1kHz.

DM	
0	De-emphasis OFF
1	De-emphasis ON (44.1kHz)

TABLE II. De-emphasis Control Selection.

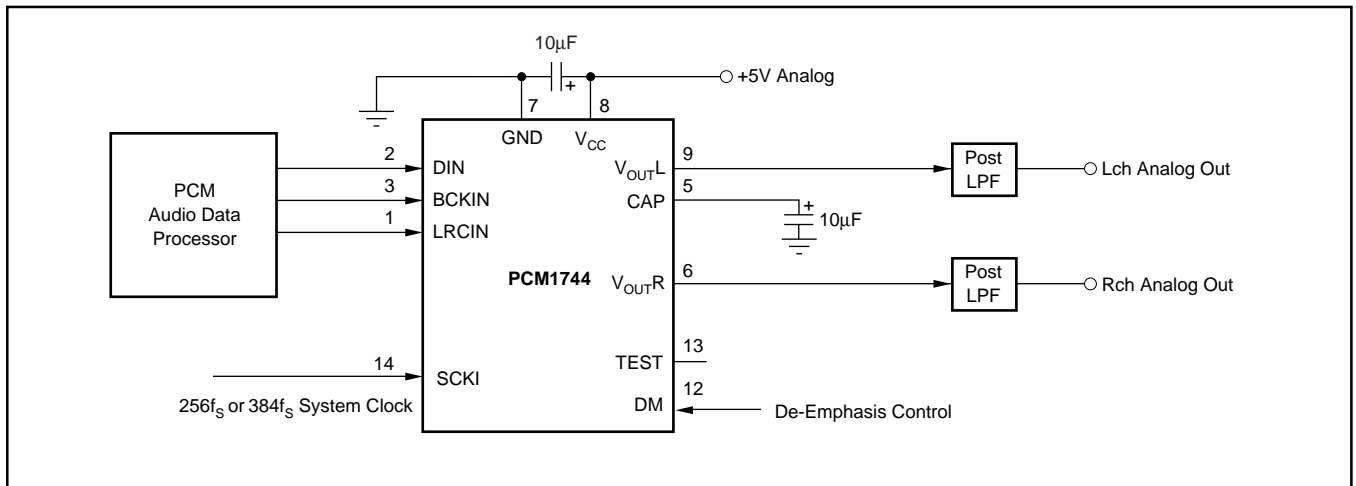

FIGURE 4. Typical Connection Diagram.

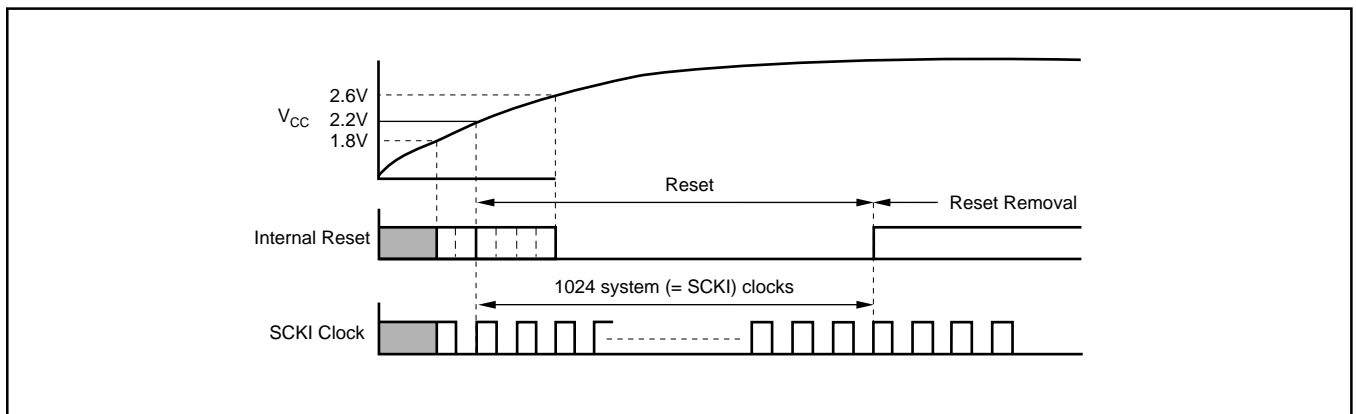

FIGURE 5. Internal Power-On Reset Timing.

APPLICATION CONSIDERATIONS

DELAY TIME

There is a finite delay time in delta-sigma converters. In A/D converters, this is commonly referred to as latency. For a delta-sigma D/A converter, delay time is determined by the order number of the FIR filter stage, and the chosen sampling rate. The following equation expresses the delay time of PCM1744:

$$T_D = 11.125 \times 1/f_s$$

$$\text{For } f_s = 44.1\text{kHz, } T_D = 11.125/44.1\text{kHz} = 251.4\mu\text{s}$$

Applications using data from a disc or tape source, such as CD audio, CD-Interactive, Video CD, DAT, Minidisc, etc., generally are not affected by delay time. For some professional applications such as broadcast audio for studios, it is important for total delay time to be less than 2ms.

OUTPUT FILTERING

For testing purposes all dynamic tests are done on the PCM1744 using a 20kHz low-pass filter. This filter limits the measured bandwidth for THD+N, etc. to 20kHz. Failure to use such a filter will result in higher THD+N and lower SNR and dynamic range readings than are found in the specifications. The low-pass filter removes out-of-band noise. Although it is not audible, it may affect dynamic specification numbers.

The performance of the internal low pass filter from DC to 24kHz is shown in Figure 6. The higher frequency roll-off of the filter is shown in Figure 7. If the user's application has the PCM1744 driving a wideband amplifier, it is recommended to use an external low-pass filter. A simple 3rd-order filter is shown in Figure 8. For some applications, a passive RC filter or 2nd-order filter may be adequate.

BYPASSING POWER SUPPLIES

The power supplies should be bypassed as close as possible to the unit. It is also recommended to include a 0.1μF ceramic capacitor in parallel with the 10μF tantalum bypass capacitor.

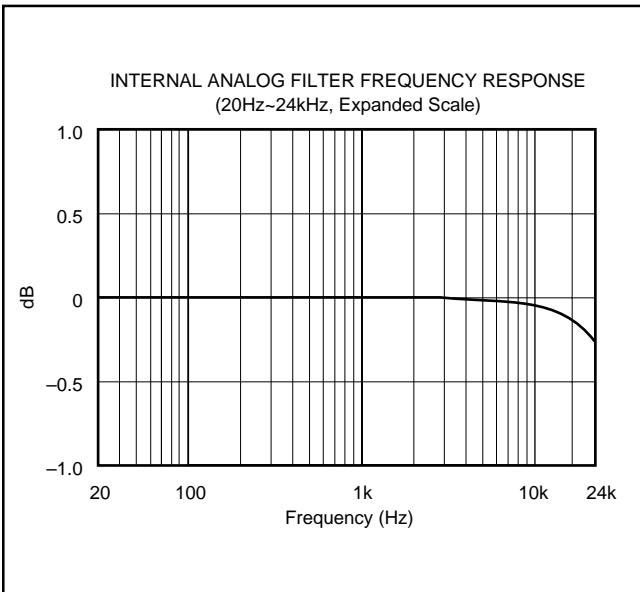

FIGURE 6. Low-Pass Filter Frequency Response.

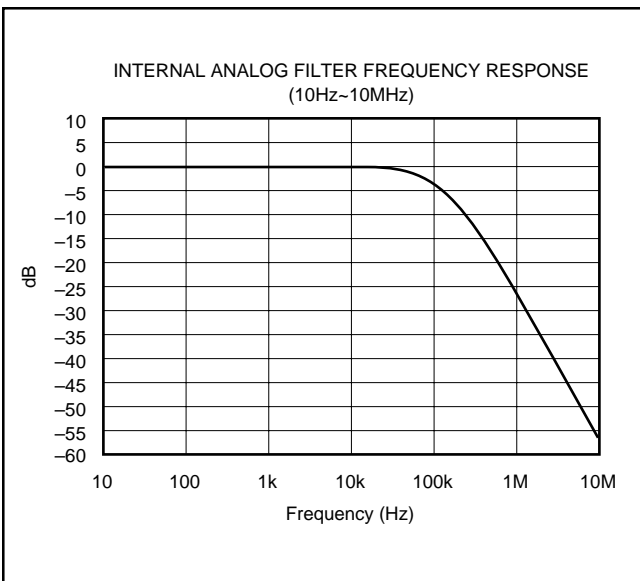

FIGURE 7. Low-Pass Filter Wideband Frequency Response.

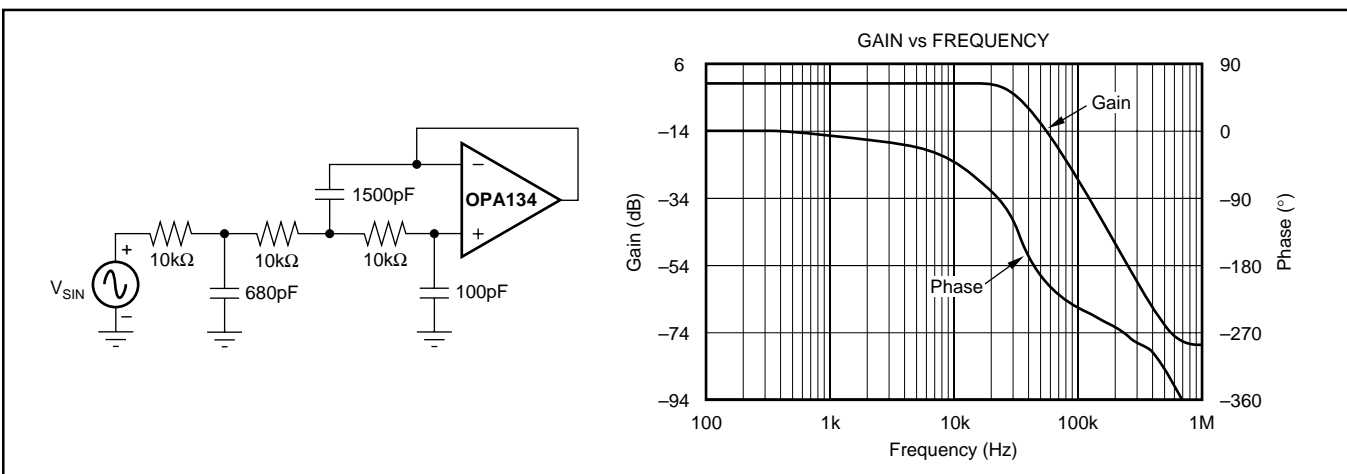

FIGURE 8. 3rd-Order LPF.

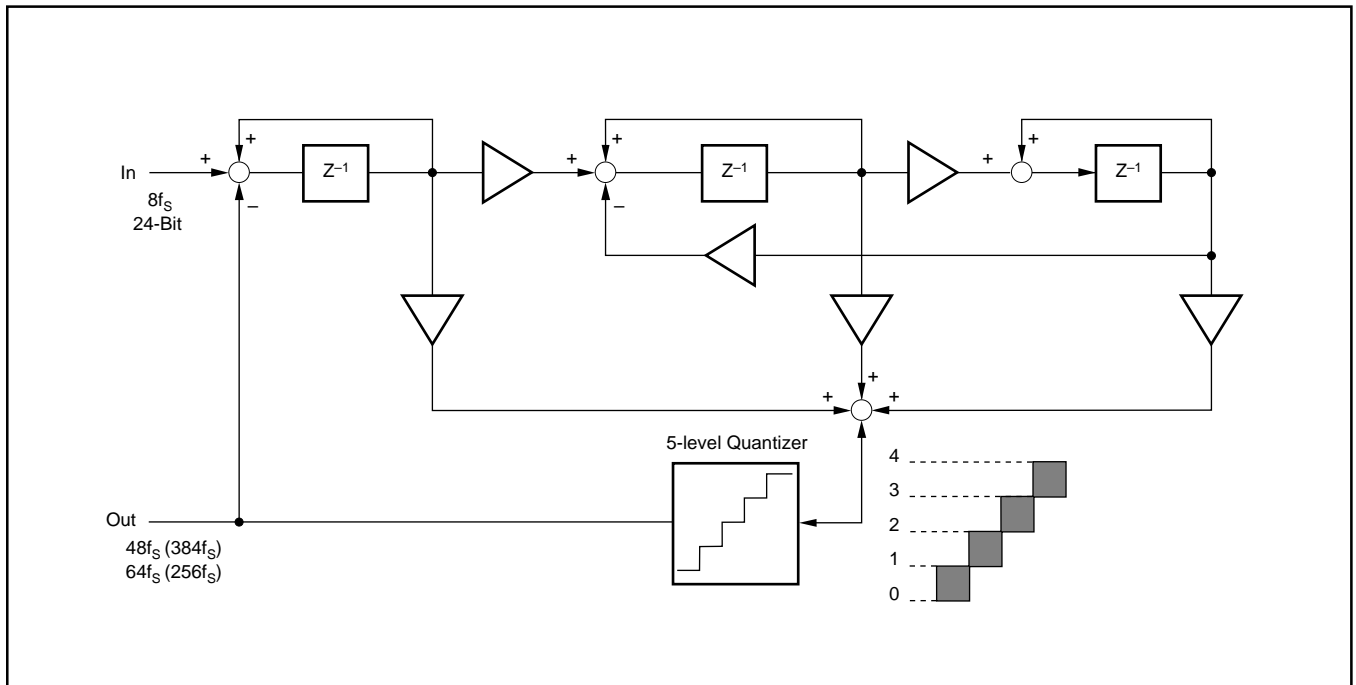

FIGURE 9. 5-Level $\Delta\Sigma$ Modulator Block Diagram.

THEORY OF OPERATION

The delta-sigma section of PCM1744 is based on a 5-level amplitude quantizer and a 3rd-order noise shaper. This section converts the oversampled input data to 5-level delta-sigma format. A block diagram of the 5-level delta-sigma modulator is shown in Figure 9. This 5-level delta-sigma modulator has the advantage of stability and clock jitter over the typical one-bit (2-level) delta-sigma modulator.

The combined oversampling rate of the delta-sigma modulator and the internal 8x interpolation filter is $96f_s$ for a $384f_s$ system clock, and $64f_s$ for a $256f_s$ system clock. The theoretical quantization noise performance of the 5-level delta-sigma modulator is shown in Figure 10.

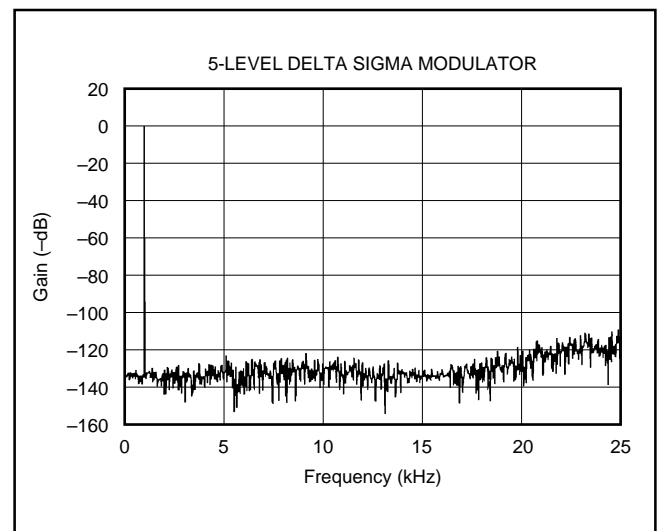

FIGURE 10. Quantization Noise Spectrum.

PACKAGING INFORMATION

Orderable Device	Status ⁽¹⁾	Package Type	Package Drawing	Pins	Package Qty	Eco Plan ⁽²⁾	Lead/Ball Finish	MSL Peak Temp ⁽³⁾
PCM1744U	ACTIVE	SOIC	D	14	56	Green (RoHS & no Sb/Br)	CU NIPDAU	Level-1-260C-UNLIM
PCM1744U/2K	ACTIVE	SOIC	D	14	2000	Green (RoHS & no Sb/Br)	CU NIPDAU	Level-1-260C-UNLIM
PCM1744U/2KG4	ACTIVE	SOIC	D	14	2000	Green (RoHS & no Sb/Br)	CU NIPDAU	Level-1-260C-UNLIM
PCM1744UG4	ACTIVE	SOIC	D	14	56	Green (RoHS & no Sb/Br)	CU NIPDAU	Level-1-260C-UNLIM

⁽¹⁾ The marketing status values are defined as follows:

ACTIVE: Product device recommended for new designs.

LIFEBUY: TI has announced that the device will be discontinued, and a lifetime-buy period is in effect.

NRND: Not recommended for new designs. Device is in production to support existing customers, but TI does not recommend using this part in a new design.

PREVIEW: Device has been announced but is not in production. Samples may or may not be available.

OBSOLETE: TI has discontinued the production of the device.

⁽²⁾ Eco Plan - The planned eco-friendly classification: Pb-Free (RoHS), Pb-Free (RoHS Exempt), or Green (RoHS & no Sb/Br) - please check <http://www.ti.com/productcontent> for the latest availability information and additional product content details.

TBD: The Pb-Free/Green conversion plan has not been defined.

Pb-Free (RoHS): TI's terms "Lead-Free" or "Pb-Free" mean semiconductor products that are compatible with the current RoHS requirements for all 6 substances, including the requirement that lead not exceed 0.1% by weight in homogeneous materials. Where designed to be soldered at high temperatures, TI Pb-Free products are suitable for use in specified lead-free processes.

Pb-Free (RoHS Exempt): This component has a RoHS exemption for either 1) lead-based flip-chip solder bumps used between the die and package, or 2) lead-based die adhesive used between the die and leadframe. The component is otherwise considered Pb-Free (RoHS compatible) as defined above.

Green (RoHS & no Sb/Br): TI defines "Green" to mean Pb-Free (RoHS compatible), and free of Bromine (Br) and Antimony (Sb) based flame retardants (Br or Sb do not exceed 0.1% by weight in homogeneous material)

⁽³⁾ MSL, Peak Temp. -- The Moisture Sensitivity Level rating according to the JEDEC industry standard classifications, and peak solder temperature.

Important Information and Disclaimer:The information provided on this page represents TI's knowledge and belief as of the date that it is provided. TI bases its knowledge and belief on information provided by third parties, and makes no representation or warranty as to the accuracy of such information. Efforts are underway to better integrate information from third parties. TI has taken and continues to take reasonable steps to provide representative and accurate information but may not have conducted destructive testing or chemical analysis on incoming materials and chemicals. TI and TI suppliers consider certain information to be proprietary, and thus CAS numbers and other limited information may not be available for release.

In no event shall TI's liability arising out of such information exceed the total purchase price of the TI part(s) at issue in this document sold by TI to Customer on an annual basis.

TAPE AND REEL INFORMATION



QUADRANT ASSIGNMENTS FOR PIN 1 ORIENTATION IN TAPE



*All dimensions are nominal

Device	Package Type	Package Drawing	Pins	SPQ	Reel Diameter (mm)	Reel Width W1 (mm)	A0 (mm)	B0 (mm)	K0 (mm)	P1 (mm)	W (mm)	Pin1 Quadrant
PCM1744U/2K	SOIC	D	14	2000	330.0	16.4	6.5	9.0	2.1	8.0	16.0	Q1

TAPE AND REEL BOX DIMENSIONS



*All dimensions are nominal

Device	Package Type	Package Drawing	Pins	SPQ	Length (mm)	Width (mm)	Height (mm)
PCM1744U/2K	SOIC	D	14	2000	346.0	346.0	33.0

IMPORTANT NOTICE

Texas Instruments Incorporated and its subsidiaries (TI) reserve the right to make corrections, modifications, enhancements, improvements, and other changes to its products and services at any time and to discontinue any product or service without notice. Customers should obtain the latest relevant information before placing orders and should verify that such information is current and complete. All products are sold subject to TI's terms and conditions of sale supplied at the time of order acknowledgment.

TI warrants performance of its hardware products to the specifications applicable at the time of sale in accordance with TI's standard warranty. Testing and other quality control techniques are used to the extent TI deems necessary to support this warranty. Except where mandated by government requirements, testing of all parameters of each product is not necessarily performed.

TI assumes no liability for applications assistance or customer product design. Customers are responsible for their products and applications using TI components. To minimize the risks associated with customer products and applications, customers should provide adequate design and operating safeguards.

TI does not warrant or represent that any license, either express or implied, is granted under any TI patent right, copyright, mask work right, or other TI intellectual property right relating to any combination, machine, or process in which TI products or services are used. Information published by TI regarding third-party products or services does not constitute a license from TI to use such products or services or a warranty or endorsement thereof. Use of such information may require a license from a third party under the patents or other intellectual property of the third party, or a license from TI under the patents or other intellectual property of TI.

Reproduction of TI information in TI data books or data sheets is permissible only if reproduction is without alteration and is accompanied by all associated warranties, conditions, limitations, and notices. Reproduction of this information with alteration is an unfair and deceptive business practice. TI is not responsible or liable for such altered documentation. Information of third parties may be subject to additional restrictions.

Resale of TI products or services with statements different from or beyond the parameters stated by TI for that product or service voids all express and any implied warranties for the associated TI product or service and is an unfair and deceptive business practice. TI is not responsible or liable for any such statements.

TI products are not authorized for use in safety-critical applications (such as life support) where a failure of the TI product would reasonably be expected to cause severe personal injury or death, unless officers of the parties have executed an agreement specifically governing such use. Buyers represent that they have all necessary expertise in the safety and regulatory ramifications of their applications, and acknowledge and agree that they are solely responsible for all legal, regulatory and safety-related requirements concerning their products and any use of TI products in such safety-critical applications, notwithstanding any applications-related information or support that may be provided by TI. Further, Buyers must fully indemnify TI and its representatives against any damages arising out of the use of TI products in such safety-critical applications.

TI products are neither designed nor intended for use in military/aerospace applications or environments unless the TI products are specifically designated by TI as military-grade or "enhanced plastic." Only products designated by TI as military-grade meet military specifications. Buyers acknowledge and agree that any such use of TI products which TI has not designated as military-grade is solely at the Buyer's risk, and that they are solely responsible for compliance with all legal and regulatory requirements in connection with such use.

TI products are neither designed nor intended for use in automotive applications or environments unless the specific TI products are designated by TI as compliant with ISO/TS 16949 requirements. Buyers acknowledge and agree that, if they use any non-designated products in automotive applications, TI will not be responsible for any failure to meet such requirements.

Following are URLs where you can obtain information on other Texas Instruments products and application solutions:

Products

Amplifiers	amplifier.ti.com
Data Converters	dataconverter.ti.com
DSP	dsp.ti.com
Clocks and Timers	www.ti.com/clocks
Interface	interface.ti.com
Logic	logic.ti.com
Power Mgmt	power.ti.com
Microcontrollers	microcontroller.ti.com
RFID	www.ti-rfid.com
RF/IF and ZigBee® Solutions	www.ti.com/lprf

Applications

Audio	www.ti.com/audio
Automotive	www.ti.com/automotive
Broadband	www.ti.com/broadband
Digital Control	www.ti.com/digitalcontrol
Medical	www.ti.com/medical
Military	www.ti.com/military
Optical Networking	www.ti.com/opticalnetwork
Security	www.ti.com/security
Telephony	www.ti.com/telephony
Video & Imaging	www.ti.com/video
Wireless	www.ti.com/wireless

Mailing Address: Texas Instruments, Post Office Box 655303, Dallas, Texas 75265
Copyright © 2008, Texas Instruments Incorporated