

# Two-Way 0° Power Splitter Combiner 0.81–0.96 GHz



PD09-12

## Features

- Low Cost
- Low Profile
- Available in Small SOIC-8 Package
- Tape & Reel

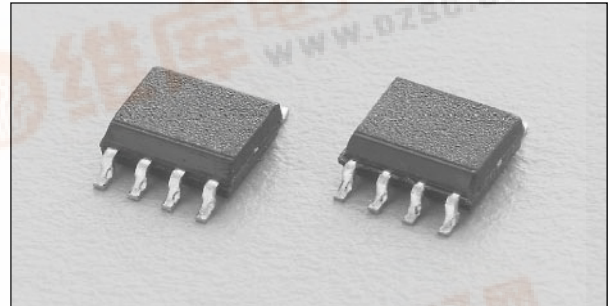

## Description

The PD09-12 is a monolithic two-way in-phase hybrid junction tuned for the 0.81–0.96 GHz band. It offers low loss, high isolation, good input/output matching and exceptional phase/amplitude balance. It is available in the SOIC-8 lead surface mount package.

## Electrical Specifications at 25°C

Parameter	Min.	Typ.	Max.	Unit
Frequency	0.81		0.96	GHz
Insertion Loss Less 3 dB Split		0.4	0.6	dB
Isolation	20	25		dB
Input VSWR		1.2:1	1.4:1	
Output VSWR		1.3:1	1.5:1	
Amplitude Balance		±0.1	±0.2	dB
Phase Balance		±1.0	±3.0	Deg.

## Pin Out

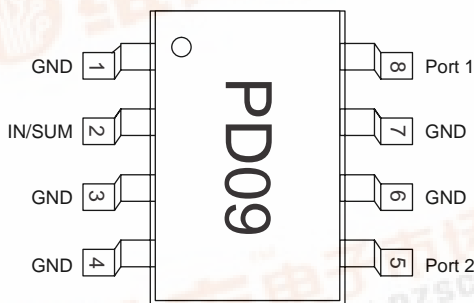

## Block Diagram

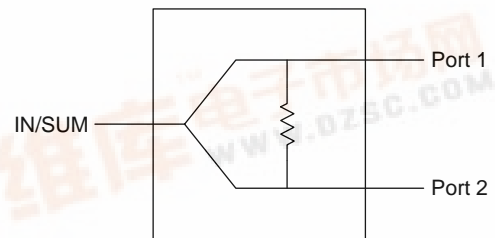

**Typical Performance Data**

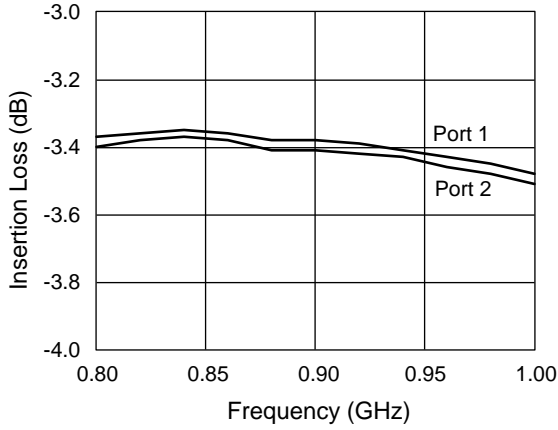

**Insertion Loss vs. Frequency**

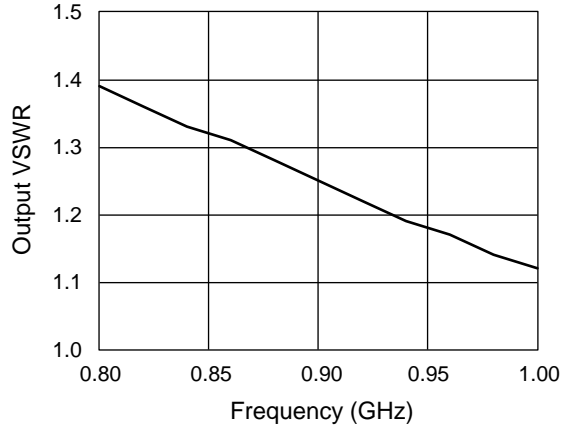

**Output VSWR vs. Frequency**

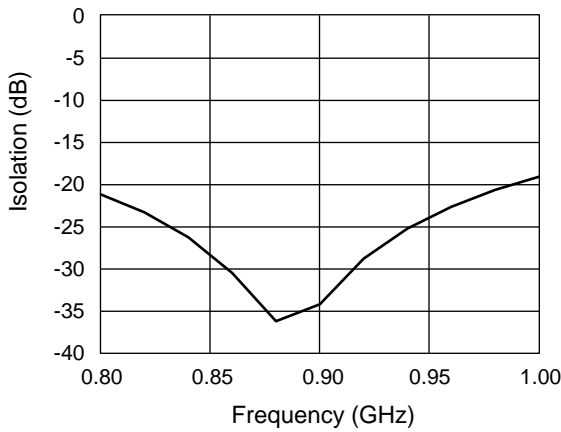

**Isolation vs. Frequency**

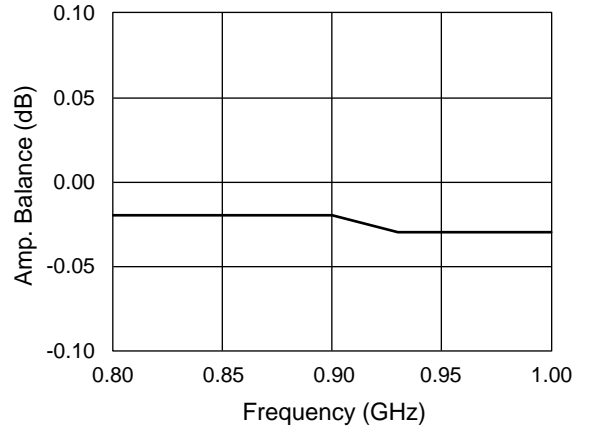

**Amp. Balance vs. Frequency**

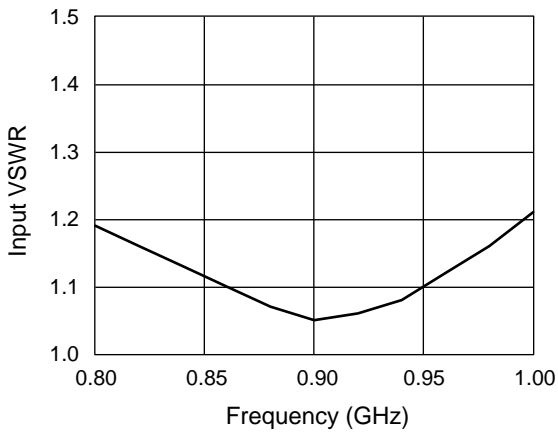

**Input VSWR vs. Frequency**

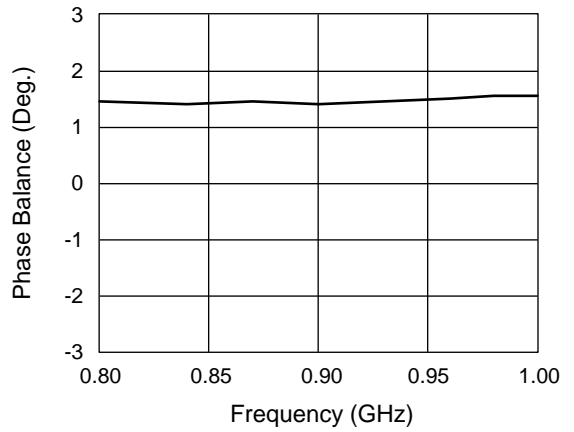

**Phase Balance vs. Frequency**

**Absolute Maximum Ratings**

Characteristic	Value
Input Power <sup>1</sup>	1.5 W CW
Input Power <sup>2</sup>	0.75 W CW
Operating Temperature	-40°C to +85°C
Storage Temperature	-65°C to +150°C

1. When used as a power divider with a 2.0:1 maximum VSWR on all ports.
2. When used as a power combiner with a 2.0:1 maximum VSWR on all ports.

**Recommended Board Layout**

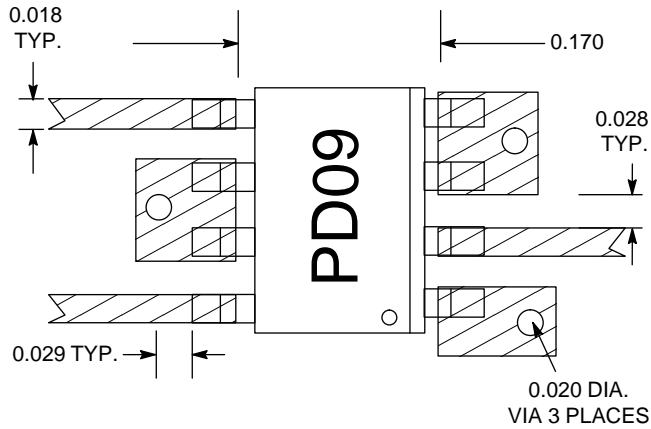

Material is 10 mil FR4

**SOIC-8**

