



# PD54008 - PD54008S

## RF POWER TRANSISTORS

### The *Ldmo*ST Plastic FAMILY

PRELIMINARY DATA

N-CHANNEL ENHANCEMENT-MODE LATERAL MOSFETs

- EXCELLENT THERMAL STABILITY
- COMMON SOURCE CONFIGURATION
- POUT = 8 W with 10 dB gain @ 500 MHz / 7.5V
- NEW RF PLASTIC PACKAGE

#### DESCRIPTION

The PD54008 is a common source N-Channel, enhancement-mode, lateral Field-Effect RF power transistor. It is designed for high gain, broad band commercial and industrial applications. It operates at 7V in common source mode at frequencies of up to 1GHz. PD54008 boasts the excellent gain, linearity and reliability of ST's latest LDMOS technology mounted in the first true SMD plastic RF power package, PowerSO-10RF. PD54008's superior linearity performance makes it an ideal solution for portable radio.

The PowerSO-10 plastic package, designed to offer high reliability, is the first ST JEDEC approved, high power SMD package. It has been specially optimized for RF needs and offers excellent RF performances and ease of assembly.

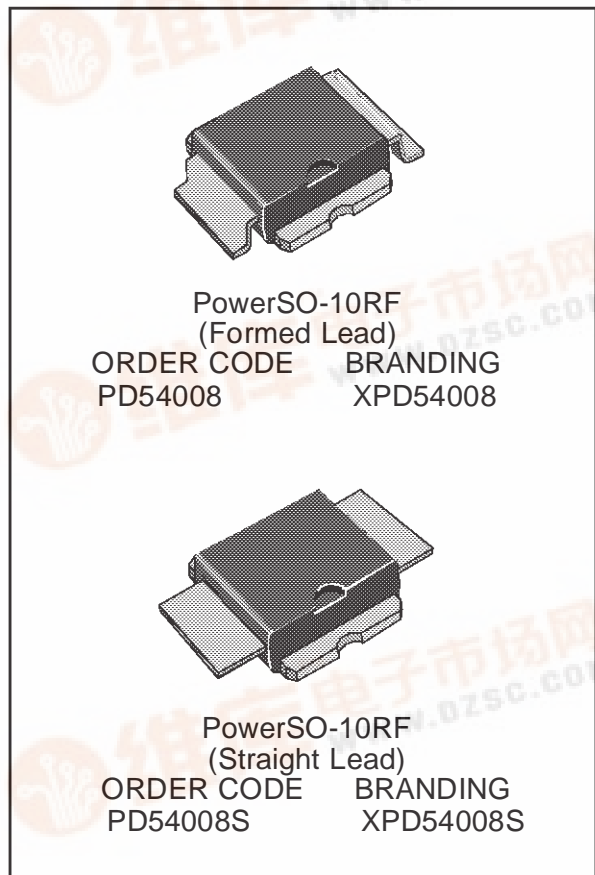

#### ABSOLUTE MAXIMUM RATINGS (T<sub>case</sub> = 25 °C)

Symbol	Parameter	Value	Unit
V <sub>(BR)DSS</sub>	Drain Source Voltage	25	V
V <sub>GS</sub>	Gate-Source Voltage	±20	V
I <sub>D</sub>	Drain Current	5	A
P <sub>DISS</sub>	Power Dissipation (@ T <sub>c</sub> = 70 °C)	73	W
T <sub>j</sub>	Max. Operating Junction Temperature	165	°C
T <sub>STG</sub>	Storage Temperature	-65 to 165	°C

#### THERMAL DATA

R <sub>th(j-c)</sub>	Junction-Case Thermal Resistance	1.3	°C/W
----------------------	----------------------------------	-----	------

**PD54008 - PD54008S**

**ELECTRICAL SPECIFICATION**( $T_{CASE} = 25\text{ }^{\circ}\text{C}$ )

**STATIC**

Symbol	Parameter			Min.	Typ.	Max.	Unit
$I_{DSS}$	$V_{GS} = 0\text{ V}$	$V_{DS} = 25\text{ V}$				1	$\mu\text{A}$
$I_{GSS}$	$V_{GS} = 20\text{ V}$	$V_{DS} = 0\text{ V}$				1	$\mu\text{A}$
$V_{GS(Q)}$	$V_{DS} = 10\text{ V}$	$I_D = 150\text{ mA}$		2.0		5.0	V
$V_{DS(ON)}$	$V_{GS} = 10\text{ V}$	$I_D = 2\text{ A}$				0.7	V
$g_{FS}$	$V_{DS} = 10\text{ V}$	$I_D = 2\text{ A}$		2.0	2.5		mho
$C_{ISS}$	$V_{GS} = 0\text{ V}$	$V_{DS} = 7.5\text{ V}$	$f = 1\text{ MHz}$		91		pF
$C_{OSS}$	$V_{GS} = 0\text{ V}$	$V_{DS} = 7.5\text{ V}$	$f = 1\text{ MHz}$		68		pF
$C_{RSS}$	$V_{GS} = 0\text{ V}$	$V_{DS} = 7.5\text{ V}$	$f = 1\text{ MHz}$		8.5		pF

**DYNAMIC**

Symbol	Parameter				Min.	Typ.	Max.	Unit
$P_{OUT}$	$f = 500\text{ MHz}$	$V_{DD} = 7.5\text{ V}$	$I_{DQ} = 150\text{ mA}$		8			W
$G_{PS}$	$f = 500\text{ MHz}$	$V_{DD} = 7.5\text{ V}$	$P_{OUT} = 8\text{ W}$	$I_{DQ} = 150\text{ mA}$		10		dB
$\eta_D$	$f = 500\text{ MHz}$	$V_{DD} = 7.5\text{ V}$	$P_{OUT} = 8\text{ W}$	$I_{DQ} = 150\text{ mA}$		50		%
LOAD Mismatch	$f = 500\text{ MHz}$	$V_{DD} = 9.5\text{ V}$	$P_{OUT} = 8\text{ W}$	$I_{DQ} = 150\text{ mA}$	20:1			VSWR
	ALL PHASE ANGLES							

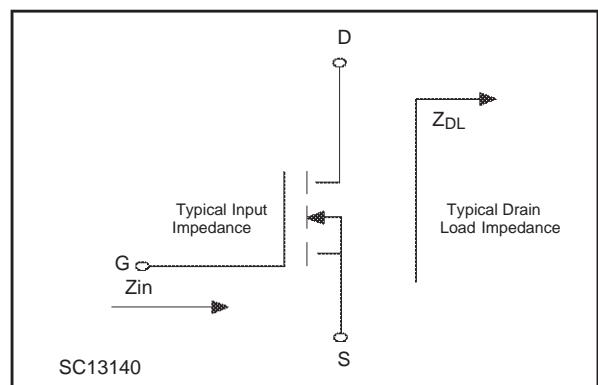
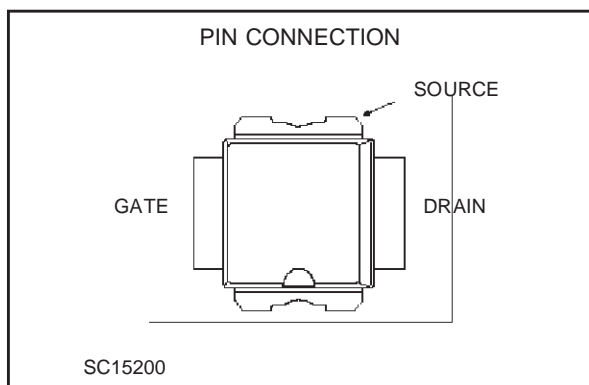

**IMPEDANCE DATA**

PD54008

Frequency MHz	$Z_{in}$ $\Omega$	$Z_{dl}$ $\Omega$
480	$2.00 - j1.44$	$1.41 - j.38$
500	$1.92 - j1.21$	$1.58 - j.70$
520	$2.18 - j.88$	$1.61 - j1.05$

PD54008S

Frequency MHz	$Z_{in}$ $\Omega$	$Z_{dl}$ $\Omega$
480	$1.69 - j1.48$	$1.65 - j.40$
500	$1.63 - j1.40$	$1.49 - j.09$
520	$1.75 - j.71$	$1.36 - j.88$

TYPICAL PERFORMANCE

Capacitance vs. Drain Voltage

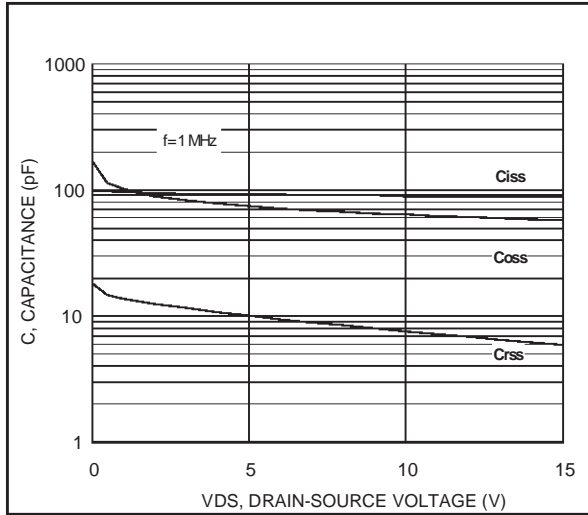

Drain Current vs. Gate Voltage

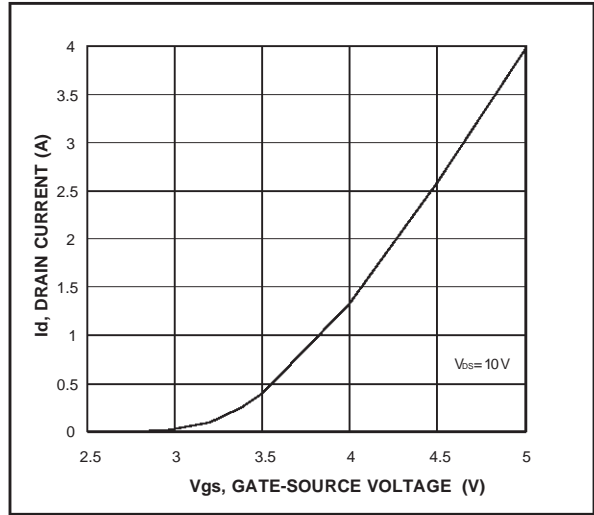

Gate-Source Voltage vs. Case Temperature

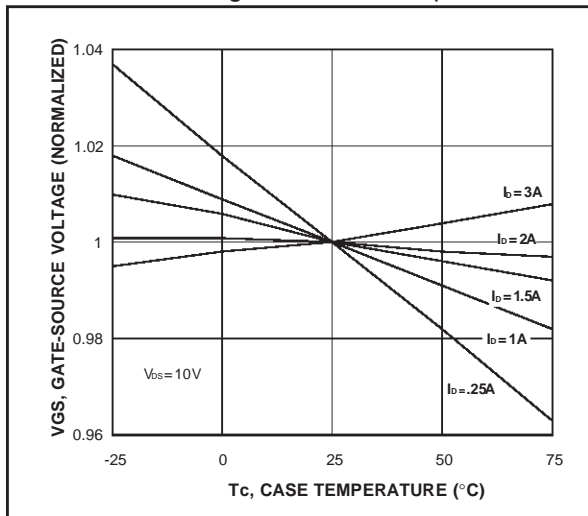

**PD54008 - PD54008S**

**TYPICAL PERFORMANCE**

Output Power vs. Input Power

**PD54008**

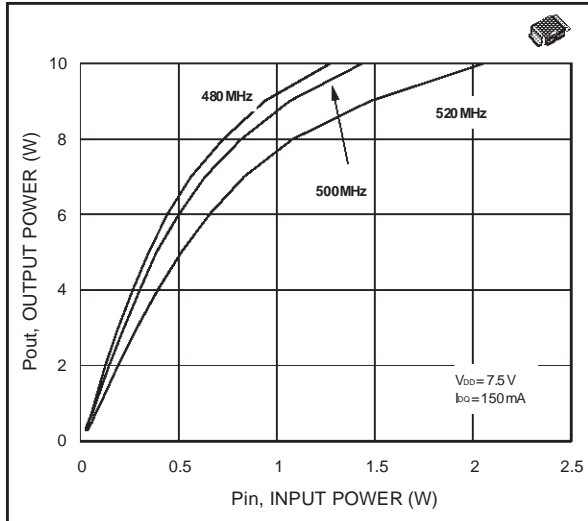

Power Gain vs. Output Power

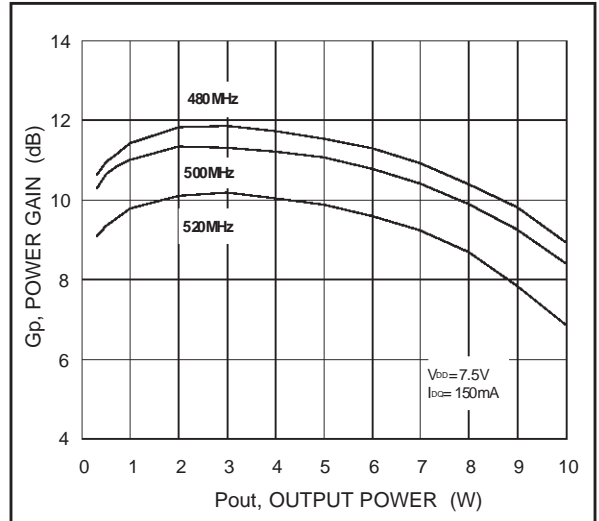

Drain Efficiency vs. Output Power

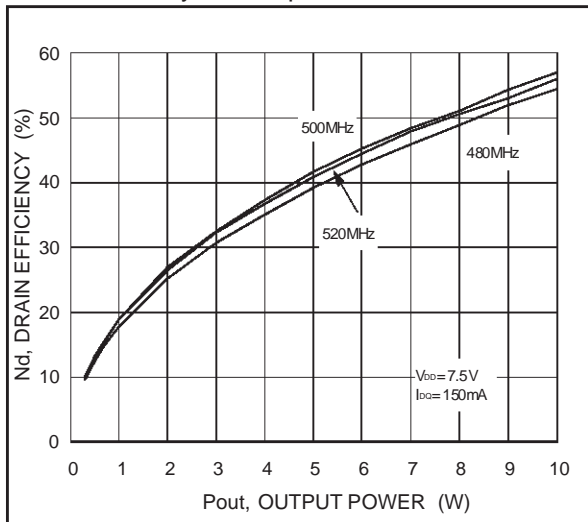

Return Loss vs. Output Power

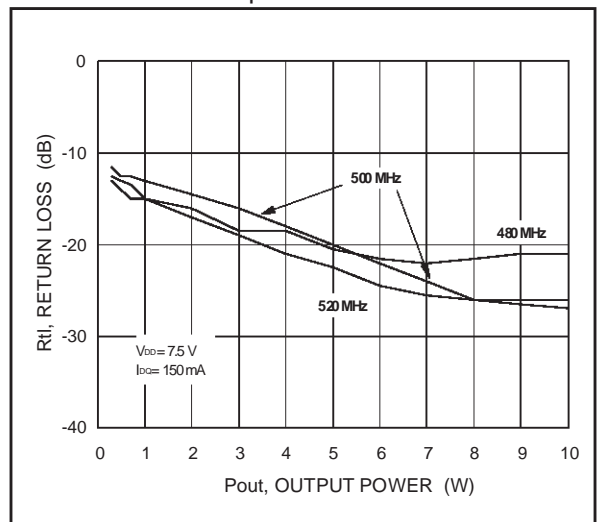

Output Power vs. Bias Current

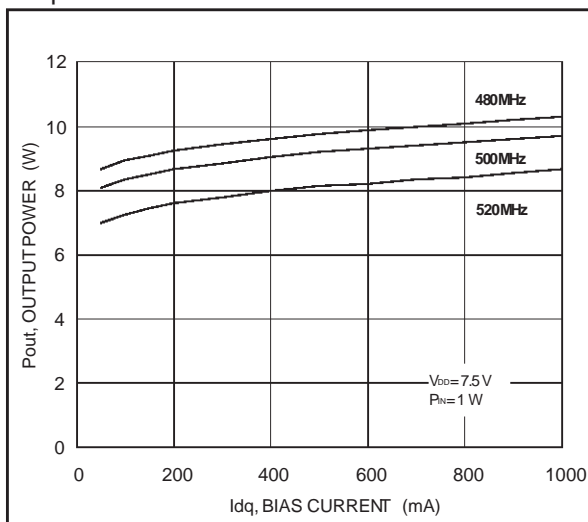

Drain Efficiency vs. Bias Current

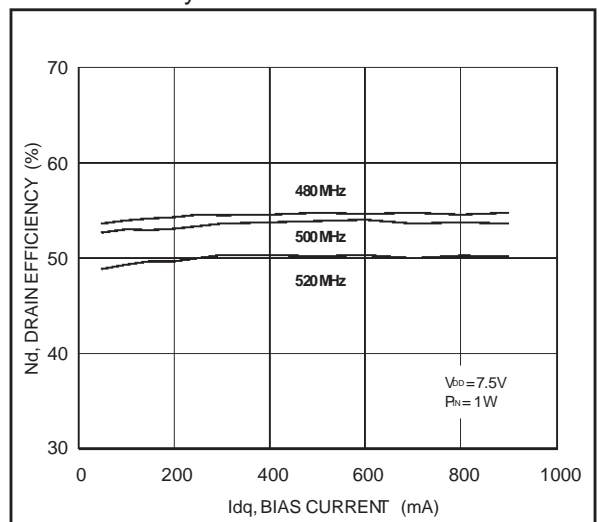

TYPICAL PERFORMANCE

Output Power vs. Drain Voltage

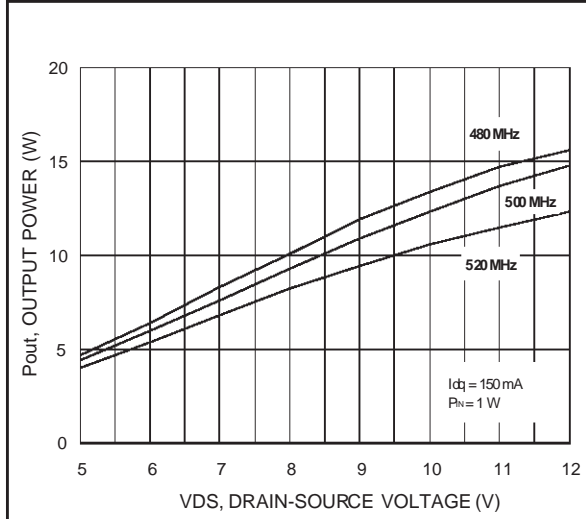

Drain Efficiency vs. Drain Voltage

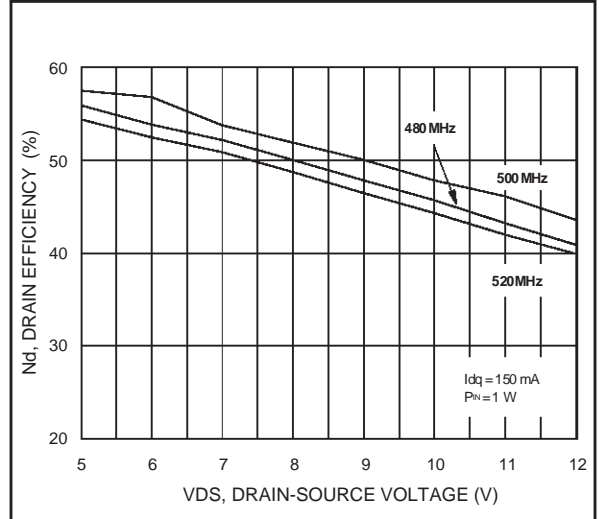

Output Power vs. Gate Bias Voltage

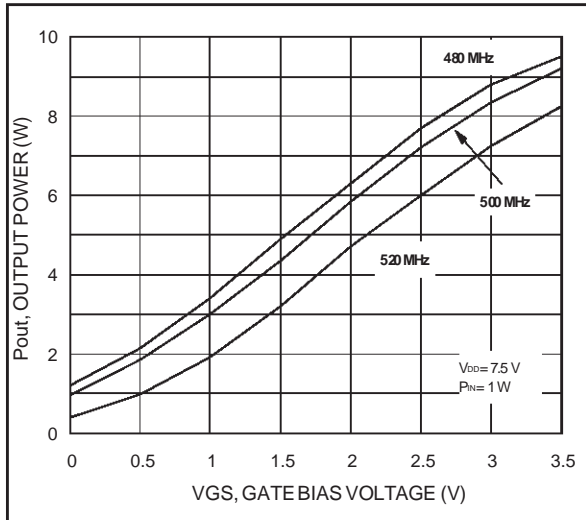

Output Power vs. Input Power PD54008S

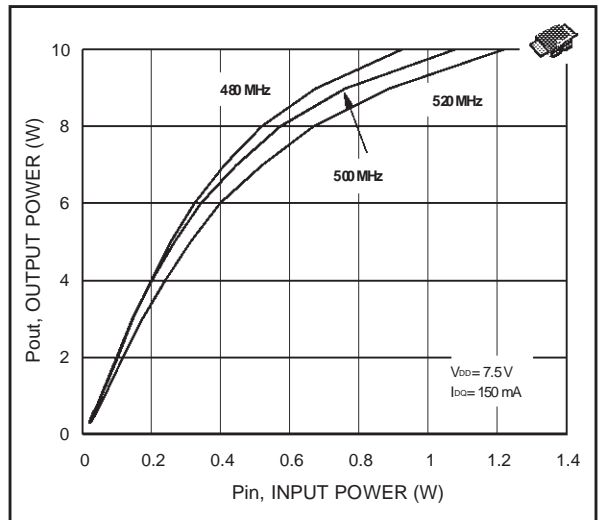

Power Gain vs. Output Power

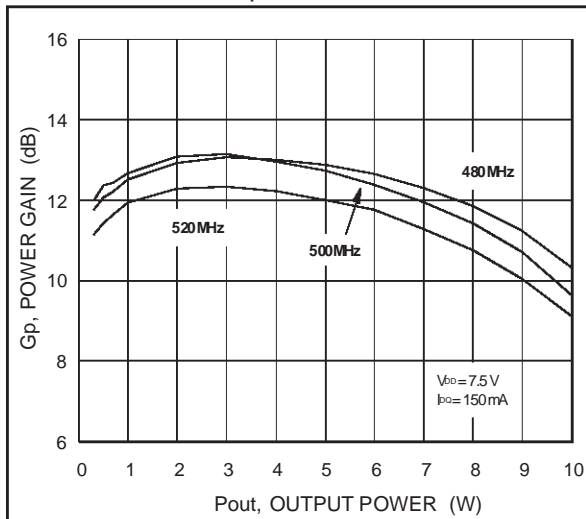

Drain Efficiency vs. Output Power

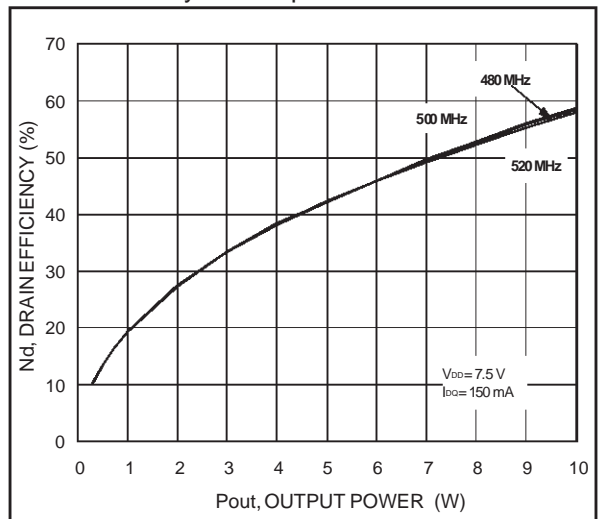

# PD54008 - PD54008S

## TYPICAL PERFORMANCE

### Return Loss vs. Output Power

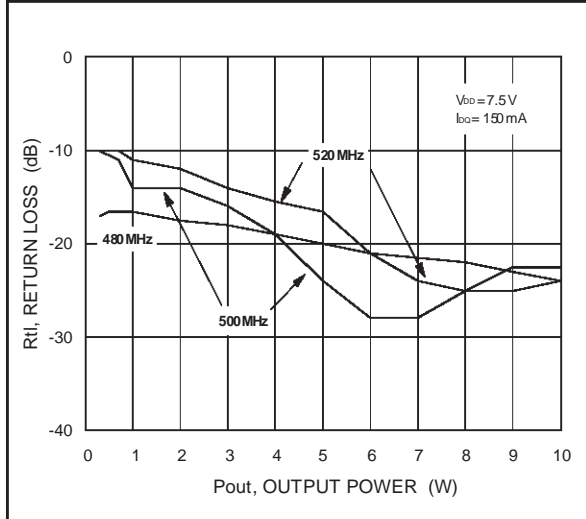

### Output Power vs. Bias Current

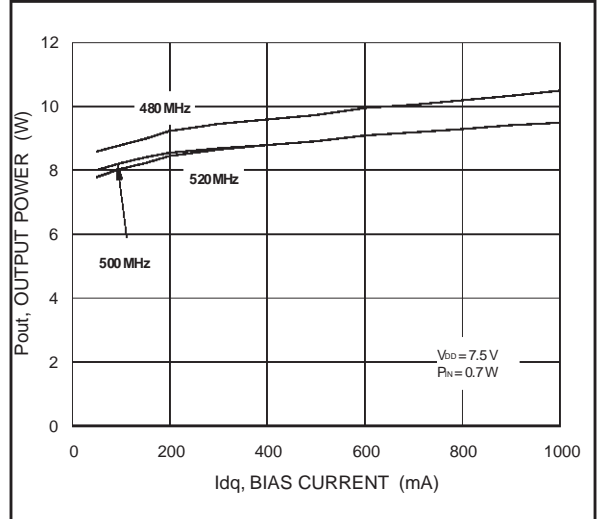

### Drain Efficiency vs. Bias Current

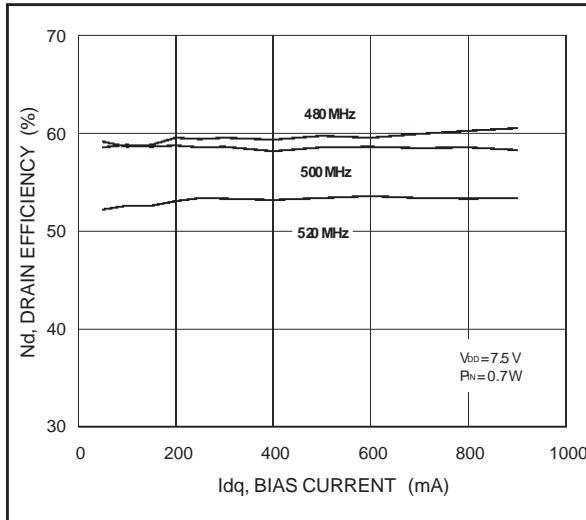

### Output Power vs. Drain Voltage

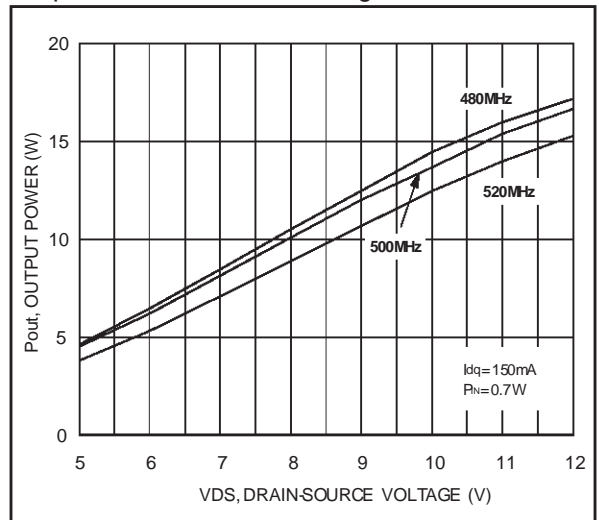

### Drain Efficiency vs. Drain Voltage

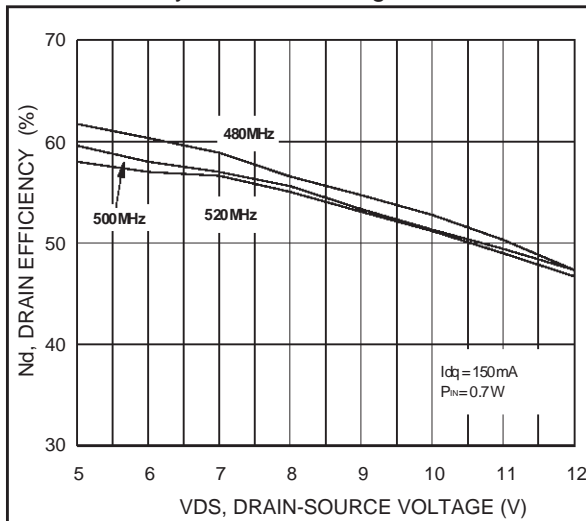

### Output Power vs. Gate Bias Voltage

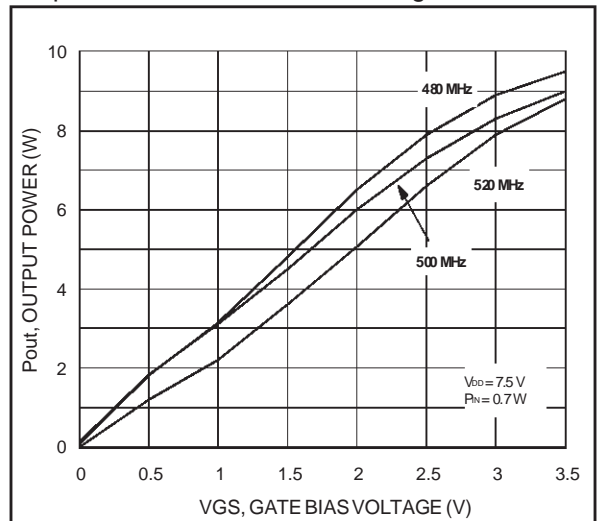

TEST CIRCUIT SCHEMATIC

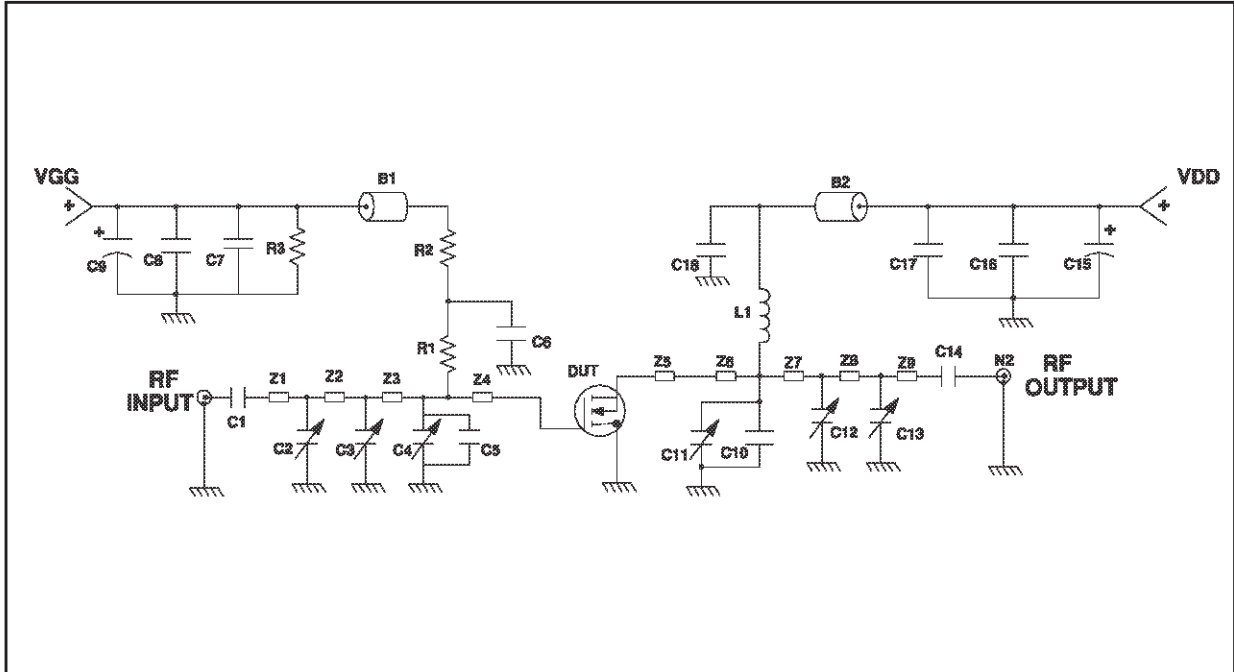

TEST CIRCUIT COMPONENT PART LIST

B1,B2	FERRITE BEAD	R2	1,0k $\Omega$ , 1W CHIP RESISTOR
C1,C14	300pF, 100 mil CHIP CAPACITOR	R3	33 k $\Omega$ , 1W CHIP RESISTOR
C2,C3,C4,C11, C12,C13	1 TO 20 pF TRIMMER CAPACITOR	Z1	0.471" X 0.080" MICROSTRIP
C6,C18	pF 100 mil CHIP CAP	Z2	1.082" X 0.080" MICROSTRIP
C9,C15	10 $\mu$ F, 50V ELECTROLYTIC CAPACITOR	Z3	0.372" X 0.080" MICROSTRIP
C8,C16	0.1mF, 100 mil CHIP CAP	Z4,Z5	0.260" X 0.223" MICROSTRIP
C7,C17	1,000pF 100 mil CHIP CAP	Z6	0.050" X 0.080" MICROSTRIP
C5, C10	33pF, 100 mil CHIP CAP	Z7	0.551" X 0.080" MICROSTRIP
L1	56nH, 7 TURN, COILCRAFT	Z8	0.825" X 0.080" MICROSTRIP
N1,N2	TYPE N FLANGE MOUNT	Z9	0.489" X 0.080" MICROSTRIP
R1	15 $\Omega$ , 1W CHIP RESISTOR	BOARD	ROGER, ULTRA LAM 2000 THK 0.030" $\epsilon_r = 2.55$ 2oz ED Cu 2 SIDES

PD54008 - PD54008S

TEST CIRCUIT

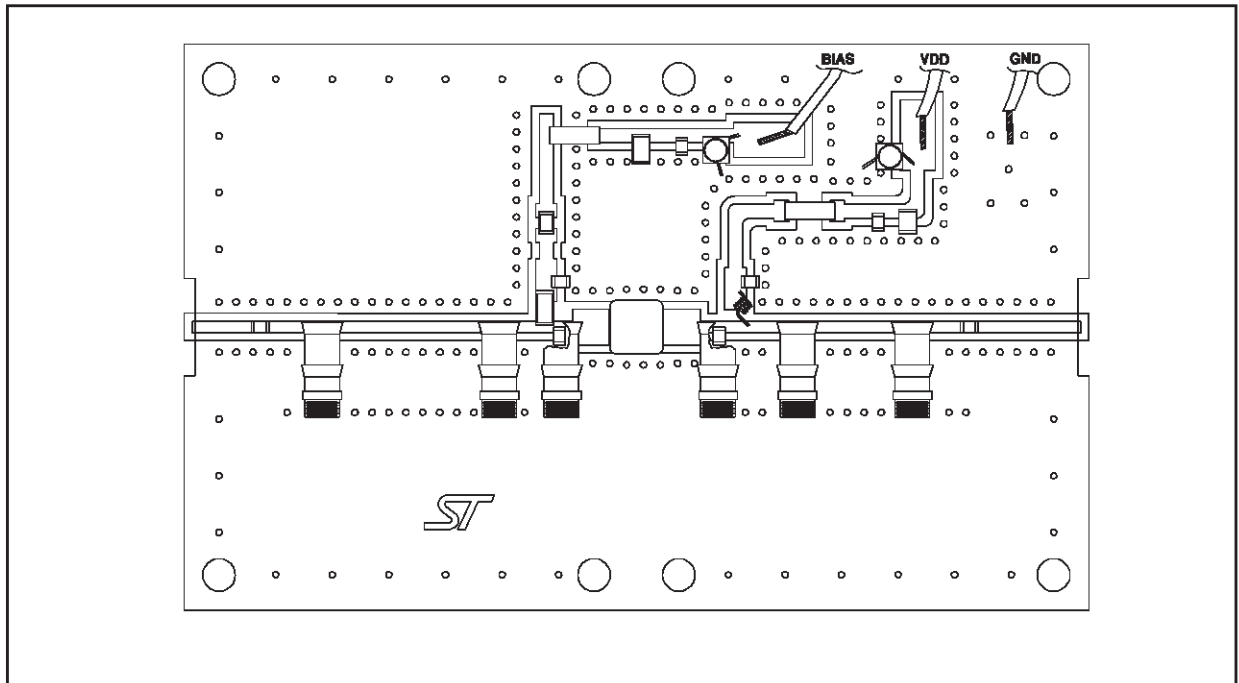

TEST CIRCUIT PHOTOMASTER

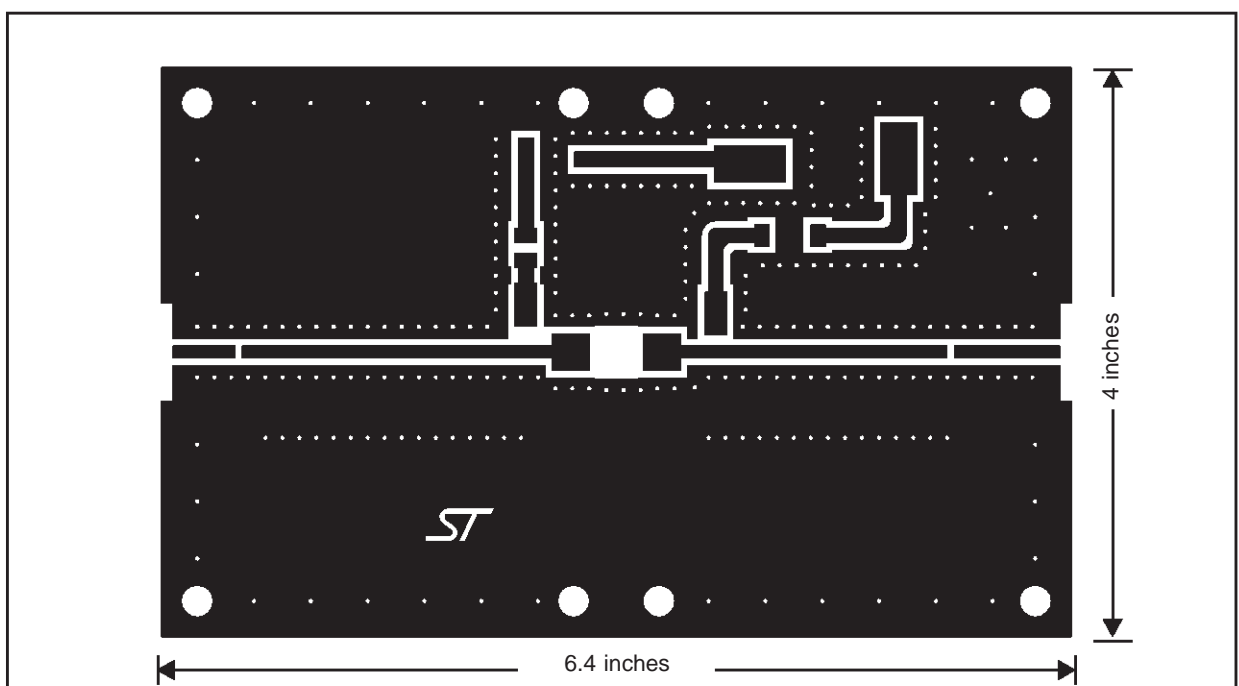



PowerSO-10RF (Straight Lead) MECHANICAL DATA

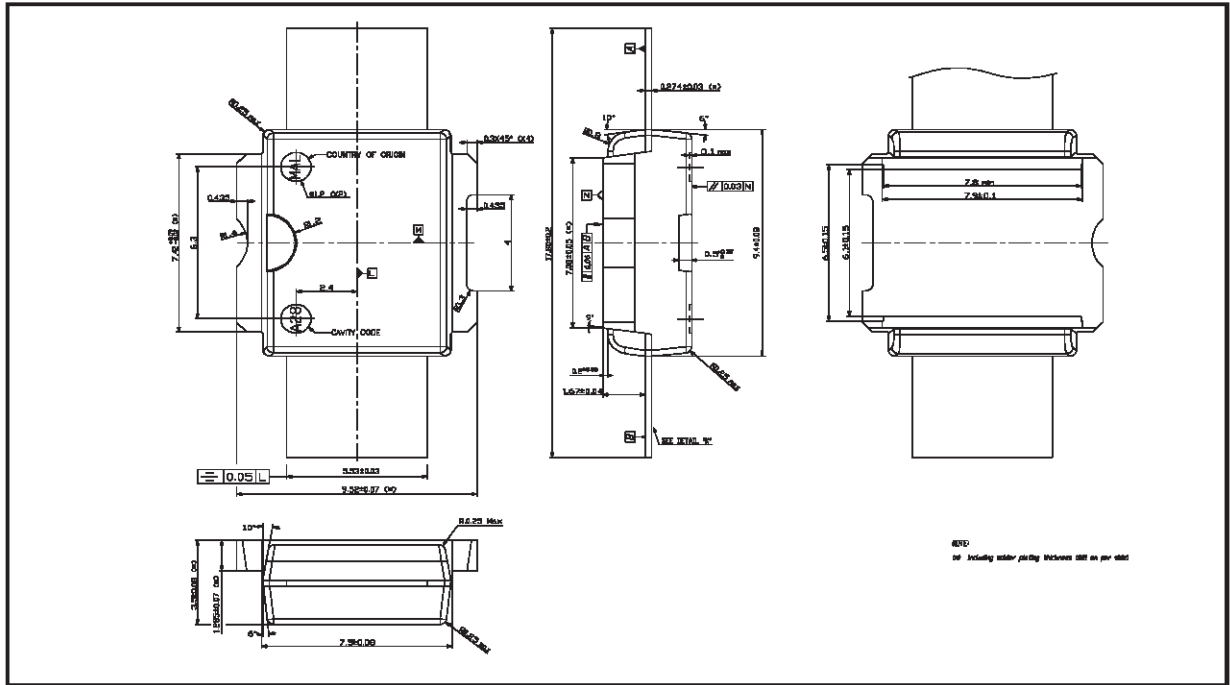

PowerSO-10RF (Formed Lead) MECHANICAL DATA

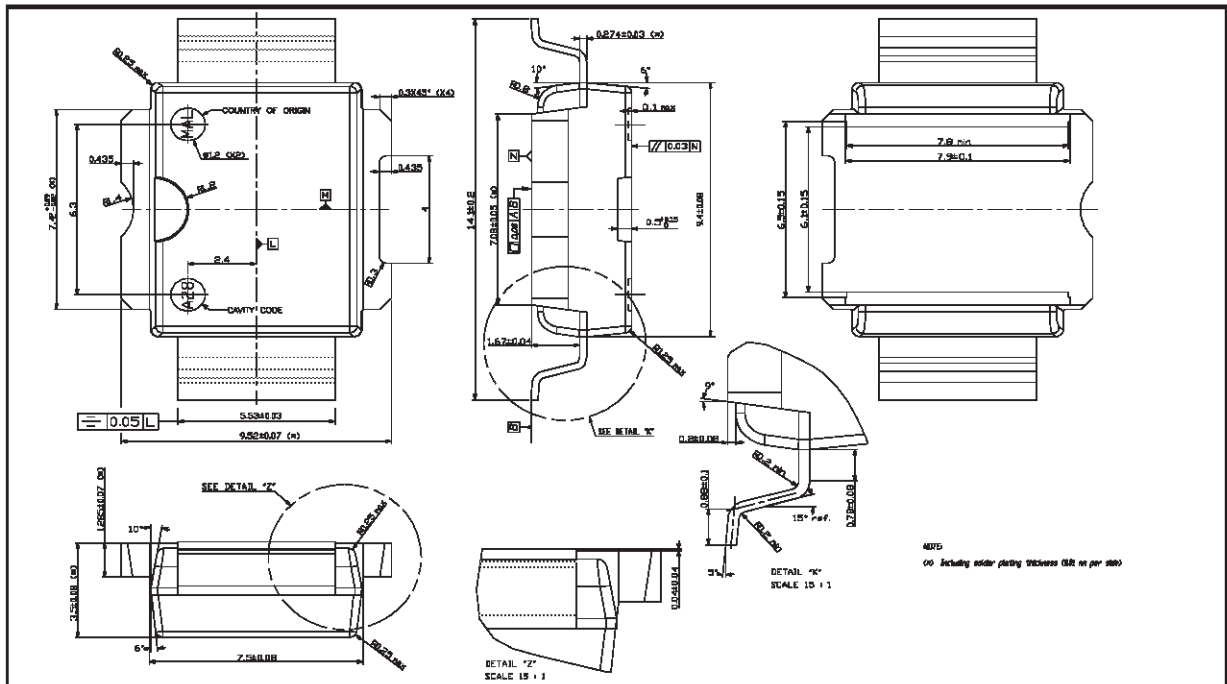

Information furnished is believed to be accurate and reliable. However, STMicroelectronics assumes no responsibility for the consequences of use of such information nor for any infringement of patents or other rights of third parties which may result from its use. No license is granted by implication or otherwise under any patent or patent rights of STMicroelectronics. Specifications mentioned in this publication are subject to change without notice. This publication supersedes and replaces all information previously supplied. STMicroelectronics products are not authorized for use as critical components in life support devices or systems without express written approval of STMicroelectronics.

The ST logo is registered trademark of STMicroelectronics  
© 2000 STMicroelectronics - All Rights Reserved

All other names are the property of their respective owners.

STMicroelectronics GROUP OF COMPANIES  
Australia - Brazil - China - Finland - France - Germany - Hong Kong - India - Italy - Japan - Malaysia - Malta - Morocco -  
Singapore - Spain - Sweden - Switzerland - United Kingdom - U.S.A.

<http://www.st.com>