

**PowerMOS transistors
Avalanche energy rated**

PHP3N60E, PHB3N60E

FEATURES

- Repetitive Avalanche Rated
- Fast switching
- Stable off-state characteristics
- High thermal cycling performance
- Low thermal resistance

SYMBOL

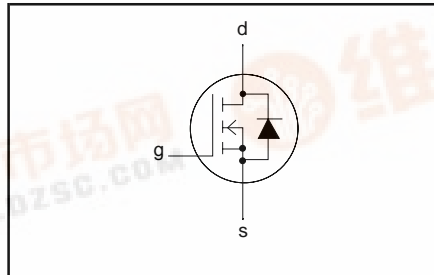

QUICK REFERENCE DATA

$V_{DSS} = 600\text{ V}$
$I_D = 2.8\text{ A}$
$R_{DS(ON)} \leq 4.4\ \Omega$

GENERAL DESCRIPTION

N-channel, enhancement mode field-effect power transistor, intended for use in off-line switched mode power supplies, T.V. and computer monitor power supplies, d.c. to d.c. converters, motor control circuits and general purpose switching applications.

The PHP3N60E is supplied in the SOT78 (TO220AB) conventional leaded package.
The PHB3N60E is supplied in the SOT404 surface mounting package.

PINNING

PIN	DESCRIPTION
1	gate
2	drain ¹
3	source
tab	drain

SOT78 (TO220AB)

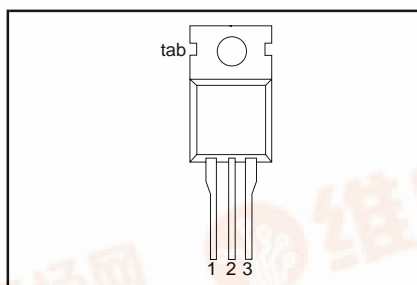

SOT404

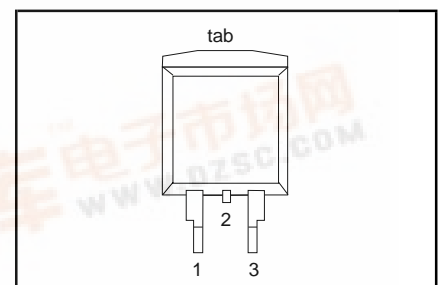

LIMITING VALUES

Limiting values in accordance with the Absolute Maximum System (IEC 134)

SYMBOL	PARAMETER	CONDITIONS	MIN.	MAX.	UNIT
V_{DSS}	Drain-source voltage	$T_j = 25\text{ }^\circ\text{C}$ to $150\text{ }^\circ\text{C}$	-	600	V
V_{DGR}	Drain-gate voltage	$T_j = 25\text{ }^\circ\text{C}$ to $150\text{ }^\circ\text{C}$; $R_{GS} = 20\text{ k}\Omega$	-	600	V
V_{GS}	Gate-source voltage		-	± 30	V
I_D	Continuous drain current	$T_{mb} = 25\text{ }^\circ\text{C}$; $V_{GS} = 10\text{ V}$	-	2.8	A
		$T_{mb} = 100\text{ }^\circ\text{C}$; $V_{GS} = 10\text{ V}$	-	1.8	A
I_{DM}	Pulsed drain current	$T_{mb} = 25\text{ }^\circ\text{C}$	-	11	A
P_D	Total dissipation	$T_{mb} = 25\text{ }^\circ\text{C}$	-	83	W
T_j, T_{stg}	Operating junction and storage temperature range		-55	150	$^\circ\text{C}$

**PowerMOS transistors
Avalanche energy rated**
PHP3N60E, PHB3N60E
AVALANCHE ENERGY LIMITING VALUES

Limiting values in accordance with the Absolute Maximum System (IEC 134)

SYMBOL	PARAMETER	CONDITIONS	MIN.	MAX.	UNIT
E_{AS}	Non-repetitive avalanche energy	Unclamped inductive load, $I_{AS} = 1.8$ A; $t_p = 0.2$ ms; T_j prior to avalanche = 25°C; $V_{DD} \leq 50$ V; $R_{GS} = 50$ Ω; $V_{GS} = 10$ V; refer to fig:17	-	139	mJ
E_{AR}	Repetitive avalanche energy ¹	$I_{AR} = 2.8$ A; $t_p = 2.5$ μs; T_j prior to avalanche = 25°C; $R_{GS} = 50$ Ω; $V_{GS} = 10$ V; refer to fig:18	-	5.5	mJ
I_{AS}, I_{AR}	Repetitive and non-repetitive avalanche current		-	2.8	A

THERMAL RESISTANCES

SYMBOL	PARAMETER	CONDITIONS	MIN.	TYP.	MAX.	UNIT
$R_{th\ j-mb}$	Thermal resistance junction to mounting base		-	-	1.5	K/W
$R_{th\ j-a}$	Thermal resistance junction to ambient	SOT78 package, in free air SOT404 package, pcb mounted, minimum footprint	-	60 50	-	K/W K/W

¹ pulse width and repetition rate limited by T_j max.

PowerMOS transistors
Avalanche energy rated
PHP3N60E, PHB3N60E
ELECTRICAL CHARACTERISTICS
 $T_j = 25\text{ °C}$ unless otherwise specified

SYMBOL	PARAMETER	CONDITIONS	MIN.	TYP.	MAX.	UNIT
$V_{(BR)DSS}$	Drain-source breakdown voltage	$V_{GS} = 0\text{ V}; I_D = 0.25\text{ mA}$	600	-	-	V
$\frac{\Delta V_{(BR)DSS}}{\Delta T_j}$	Drain-source breakdown voltage temperature coefficient	$V_{DS} = V_{GS}; I_D = 0.25\text{ mA}$	-	0.1	-	%/K
$R_{DS(ON)}$	Drain-source on resistance	$V_{GS} = 10\text{ V}; I_D = 1.4\text{ A}$	-	4	4.4	Ω
$V_{GS(TO)}$	Gate threshold voltage	$V_{DS} = V_{GS}; I_D = 0.25\text{ mA}$	2.0	3.0	4.0	V
g_{fs}	Forward transconductance	$V_{DS} = 30\text{ V}; I_D = 1.4\text{ A}$	0.7	1.7	-	S
I_{DSS}	Drain-source leakage current	$V_{DS} = 600\text{ V}; V_{GS} = 0\text{ V}$	-	1	100	μA
I_{GSS}	Gate-source leakage current	$V_{DS} = 480\text{ V}; V_{GS} = 0\text{ V}; T_j = 125\text{ °C}$ $V_{GS} = \pm 30\text{ V}; V_{DS} = 0\text{ V}$	-	50	500	μA
I_{GSS}	Gate-source leakage current	$V_{GS} = \pm 30\text{ V}; V_{DS} = 0\text{ V}$	-	10	200	nA
$Q_{g(tot)}$	Total gate charge	$I_D = 2.8\text{ A}; V_{DD} = 480\text{ V}; V_{GS} = 10\text{ V}$	-	25	30	nC
Q_{gs}	Gate-source charge		-	2	3	nC
Q_{gd}	Gate-drain (Miller) charge		-	12	15	nC
$t_{d(on)}$	Turn-on delay time	$V_{DD} = 300\text{ V}; R_D = 100\text{ }\Omega;$	-	10	-	ns
t_r	Turn-on rise time	$R_G = 18\text{ }\Omega$	-	26	-	ns
$t_{d(off)}$	Turn-off delay time		-	66	-	ns
t_f	Turn-off fall time		-	30	-	ns
L_d	Internal drain inductance	Measured from tab to centre of die	-	3.5	-	nH
L_d	Internal drain inductance	Measured from drain lead to centre of die (SOT78 package only)	-	4.5	-	nH
L_s	Internal source inductance	Measured from source lead to source bond pad	-	7.5	-	nH
C_{ISS}	Input capacitance	$V_{GS} = 0\text{ V}; V_{DS} = 25\text{ V}; f = 1\text{ MHz}$	-	300	-	pF
C_{OSS}	Output capacitance		-	43	-	pF
C_{RSS}	Feedback capacitance		-	25	-	pF

SOURCE-DRAIN DIODE RATINGS AND CHARACTERISTICS
 $T_j = 25\text{ °C}$ unless otherwise specified

SYMBOL	PARAMETER	CONDITIONS	MIN.	TYP.	MAX.	UNIT
I_S	Continuous source current (body diode)	$T_{mb} = 25\text{ °C}$	-	-	2.8	A
I_{SM}	Pulsed source current (body diode)	$T_{mb} = 25\text{ °C}$	-	-	11	A
V_{SD}	Diode forward voltage	$I_S = 2.8\text{ A}; V_{GS} = 0\text{ V}$	-	-	1.2	V
t_{rr}	Reverse recovery time	$I_S = 2.8\text{ A}; V_{GS} = 0\text{ V}; dI/dt = 100\text{ A}/\mu\text{s}$	-	500	-	ns
Q_{rr}	Reverse recovery charge		-	3	-	μC

PowerMOS transistors
Avalanche energy rated

PHP3N60E, PHB3N60E

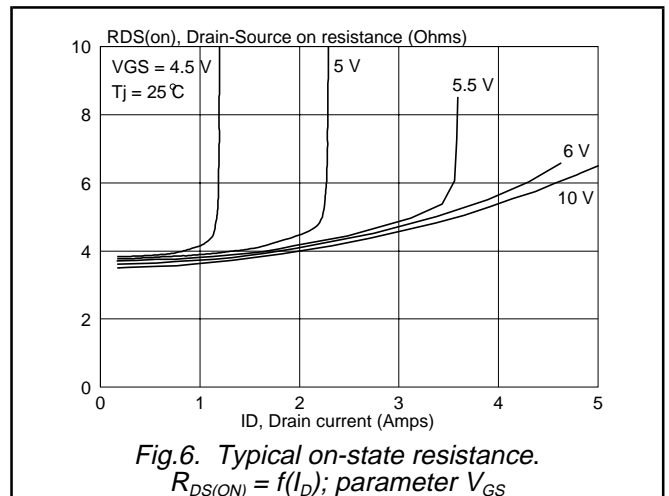
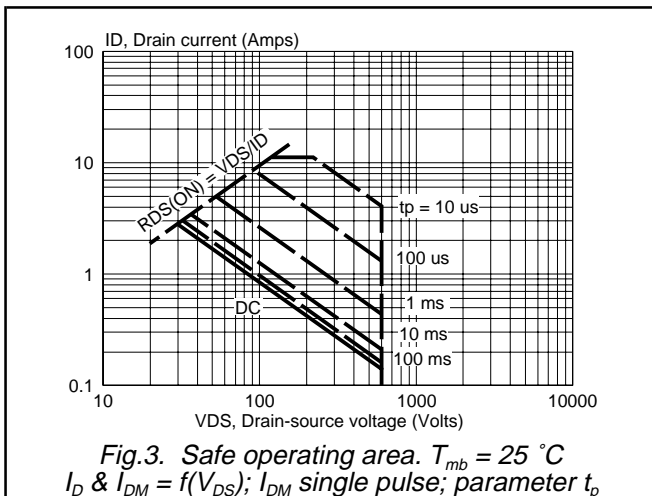
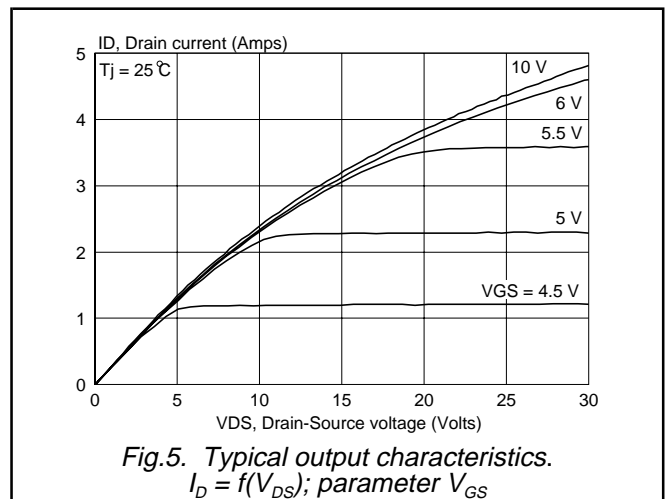
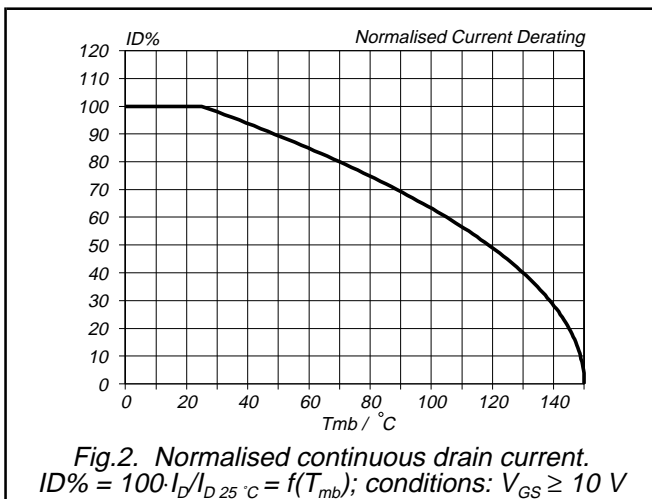
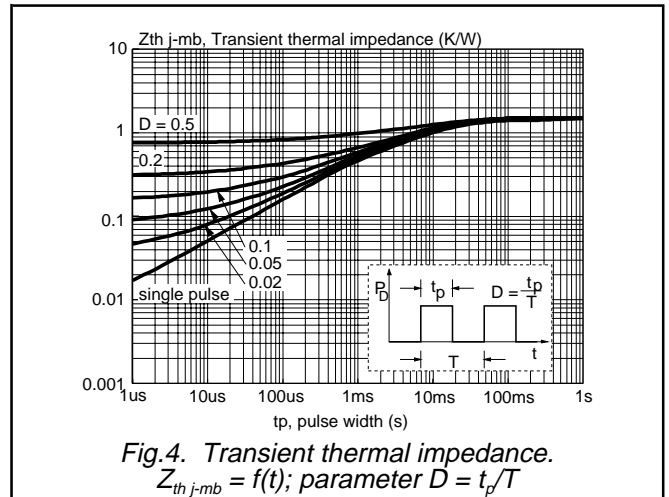
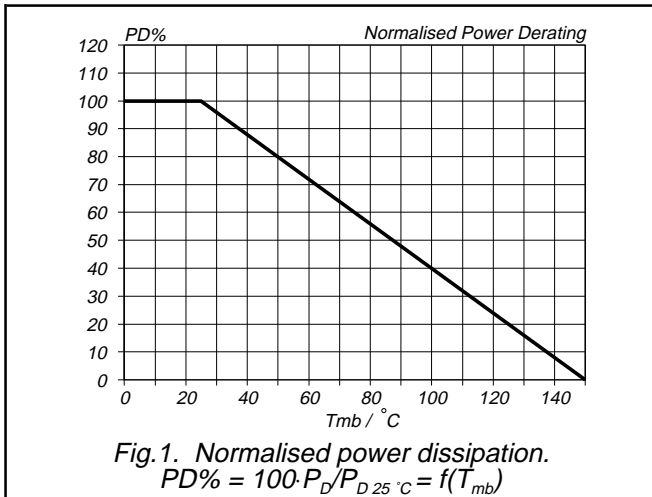

PowerMOS transistors
Avalanche energy rated

PHP3N60E, PHB3N60E

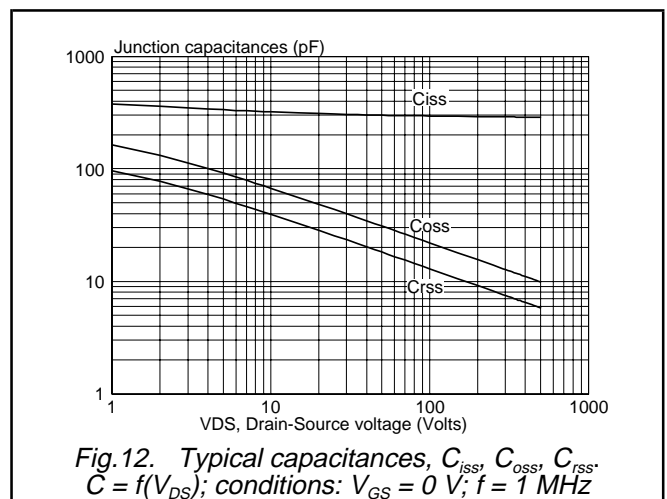
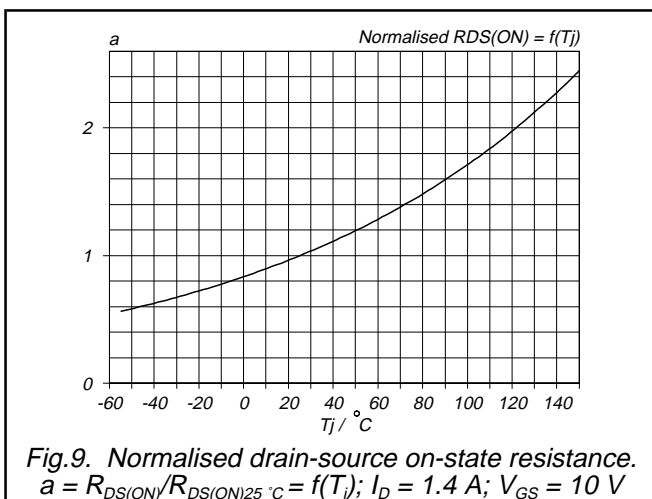
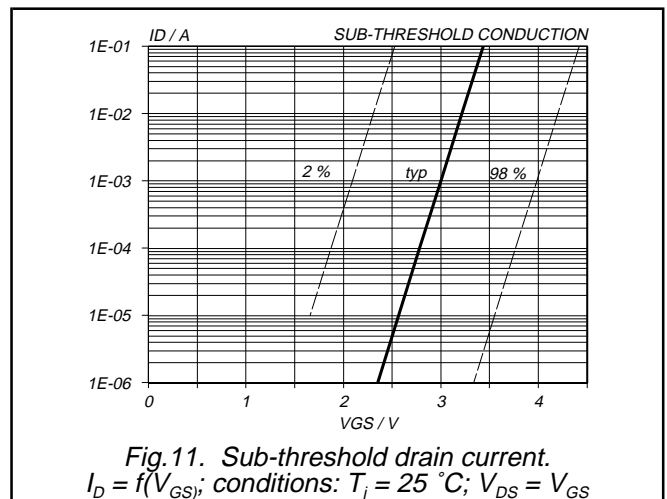
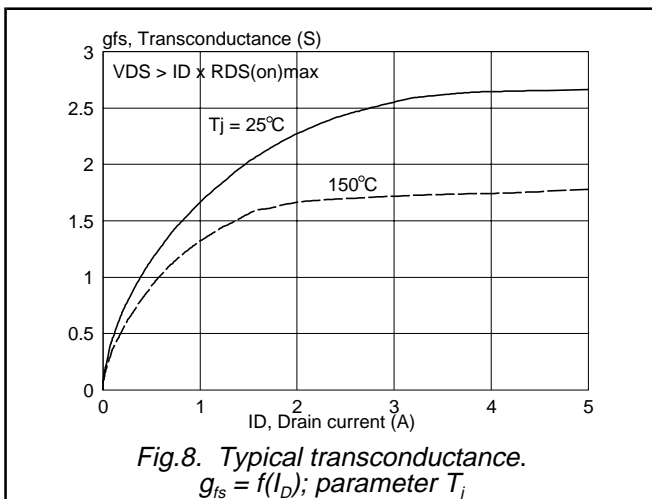
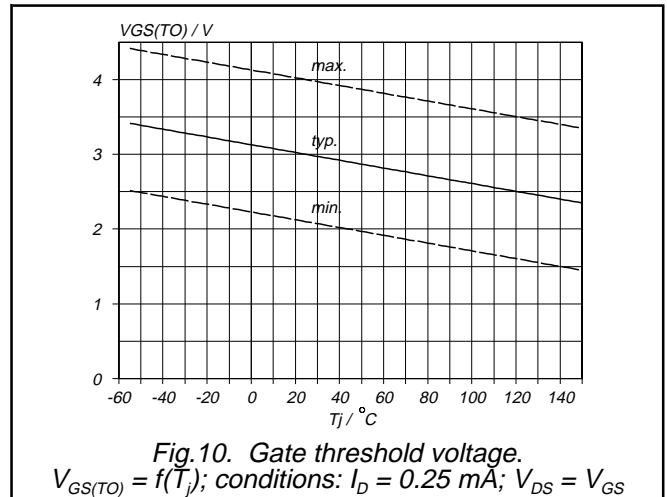
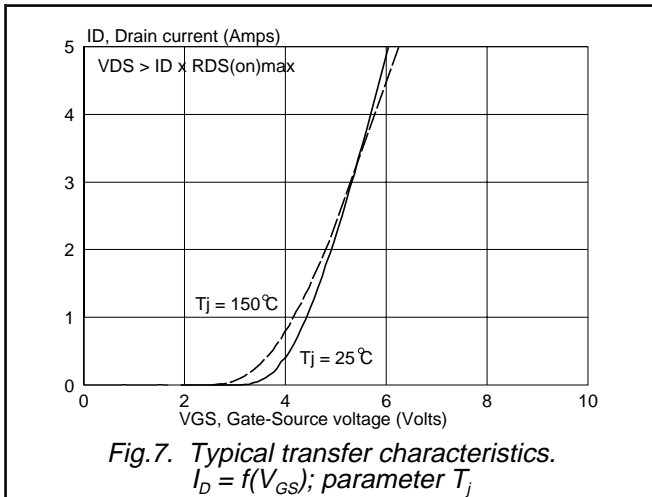

PowerMOS transistors
Avalanche energy rated

PHP3N60E, PHB3N60E

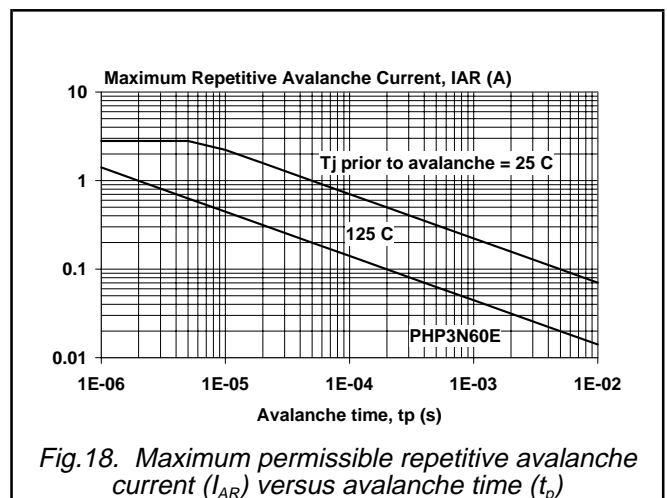
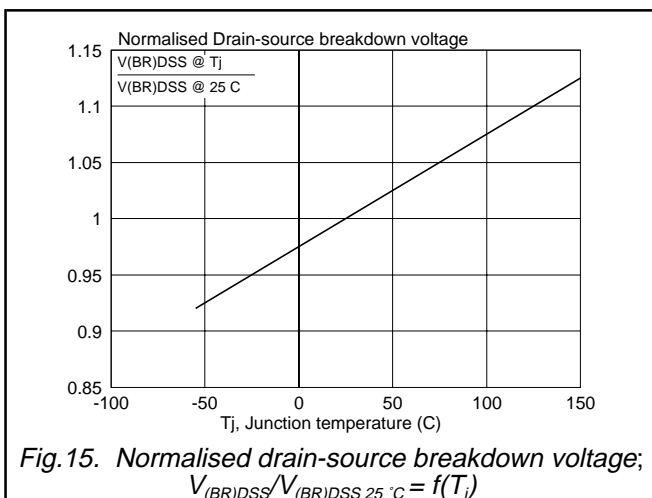
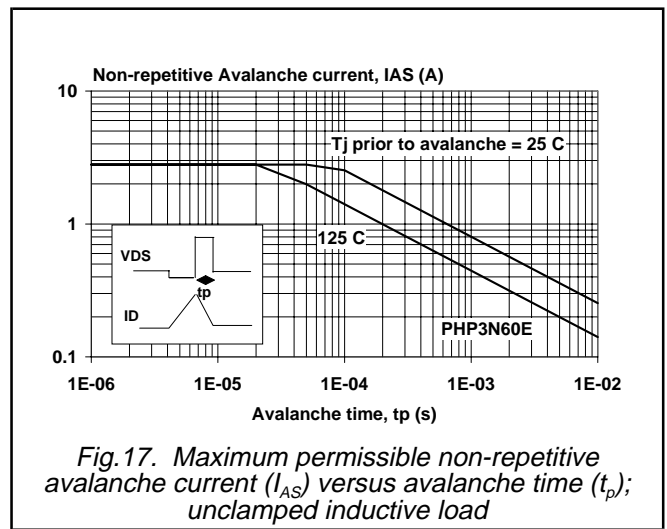
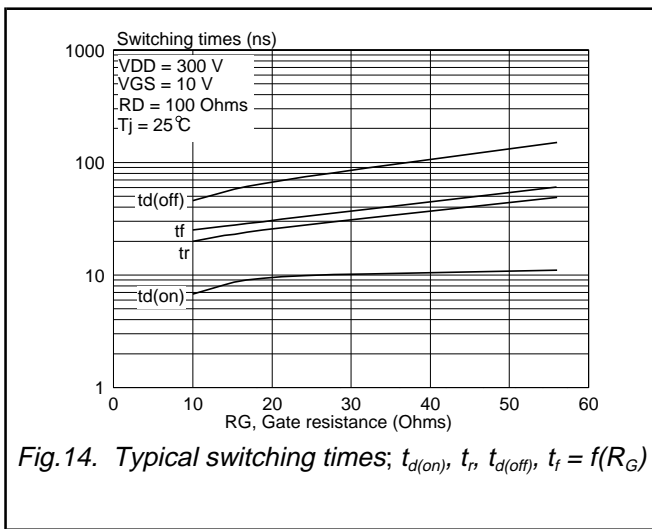
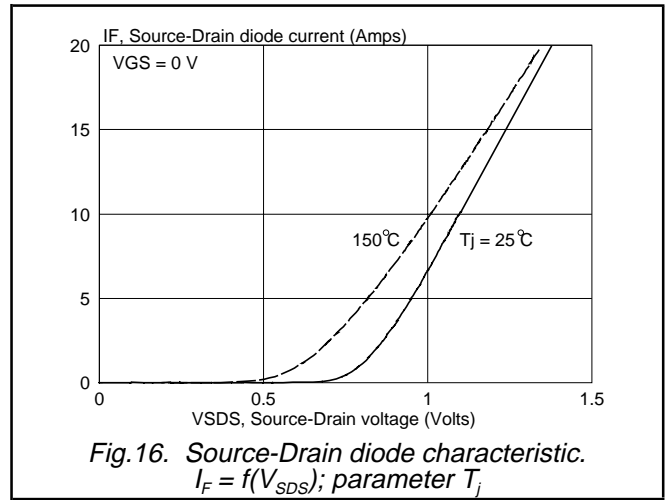
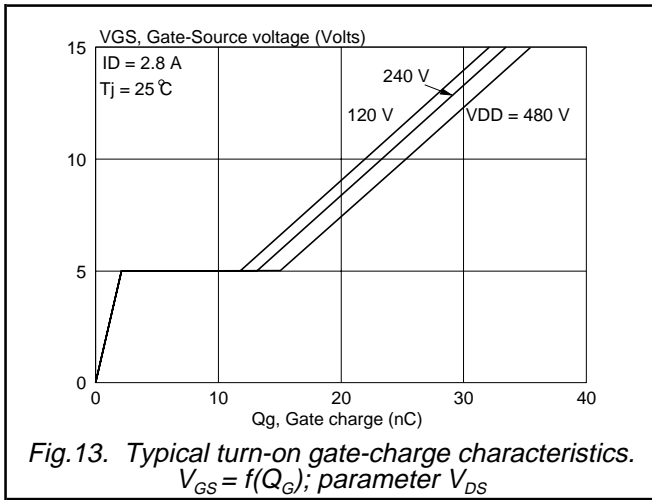

PowerMOS transistors
Avalanche energy rated

PHP3N60E, PHB3N60E

MECHANICAL DATA

Dimensions in mm

Net Mass: 2 g

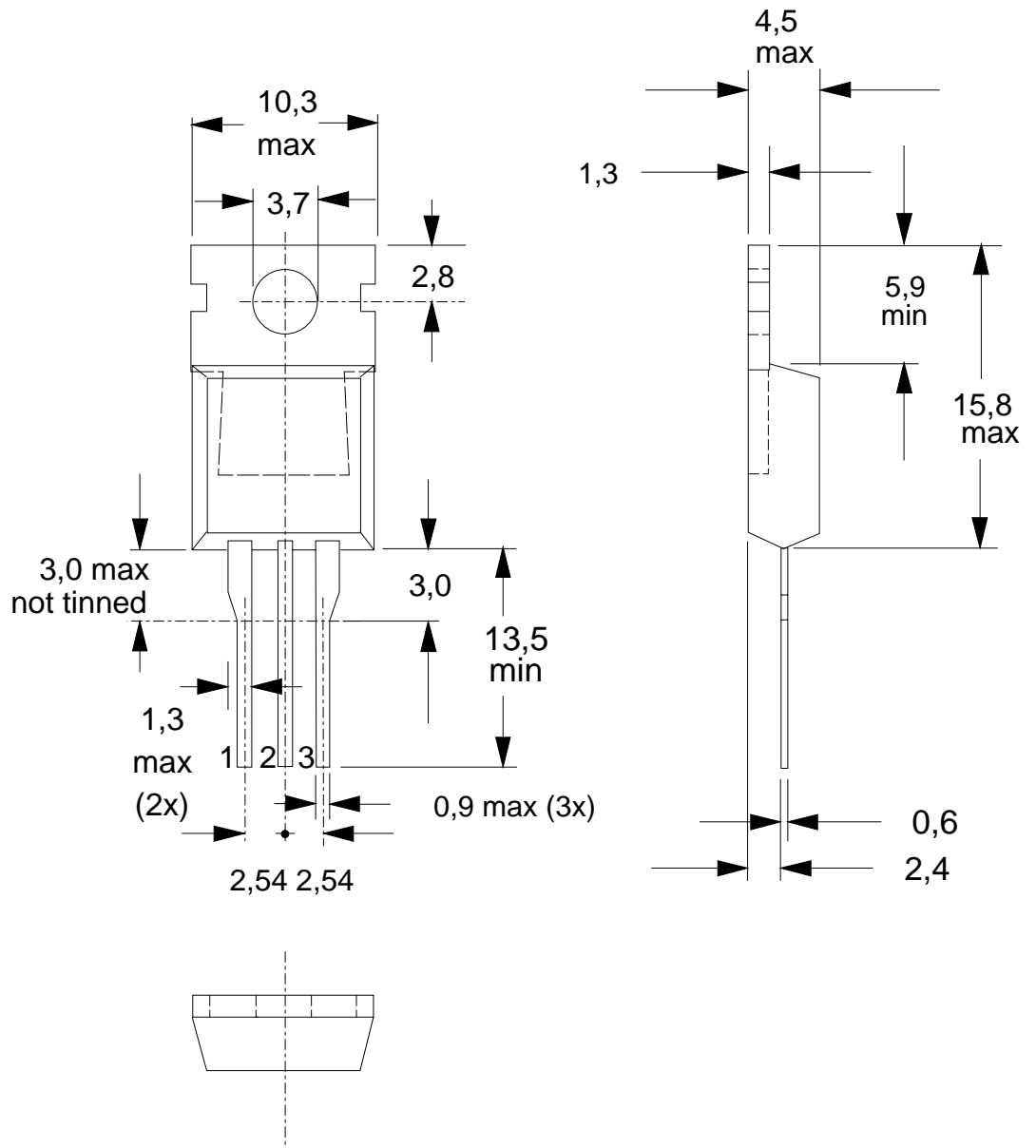

Fig.19. SOT78 (TO220AB); pin 2 connected to mounting base.

Notes

1. Observe the general handling precautions for electrostatic-discharge sensitive devices (ESDs) to prevent damage to MOS gate oxide.
2. Refer to mounting instructions for SOT78 (TO220) envelopes.
3. Epoxy meets UL94 V0 at 1/8".

PowerMOS transistors
Avalanche energy rated

PHP3N60E, PHB3N60E

MECHANICAL DATA

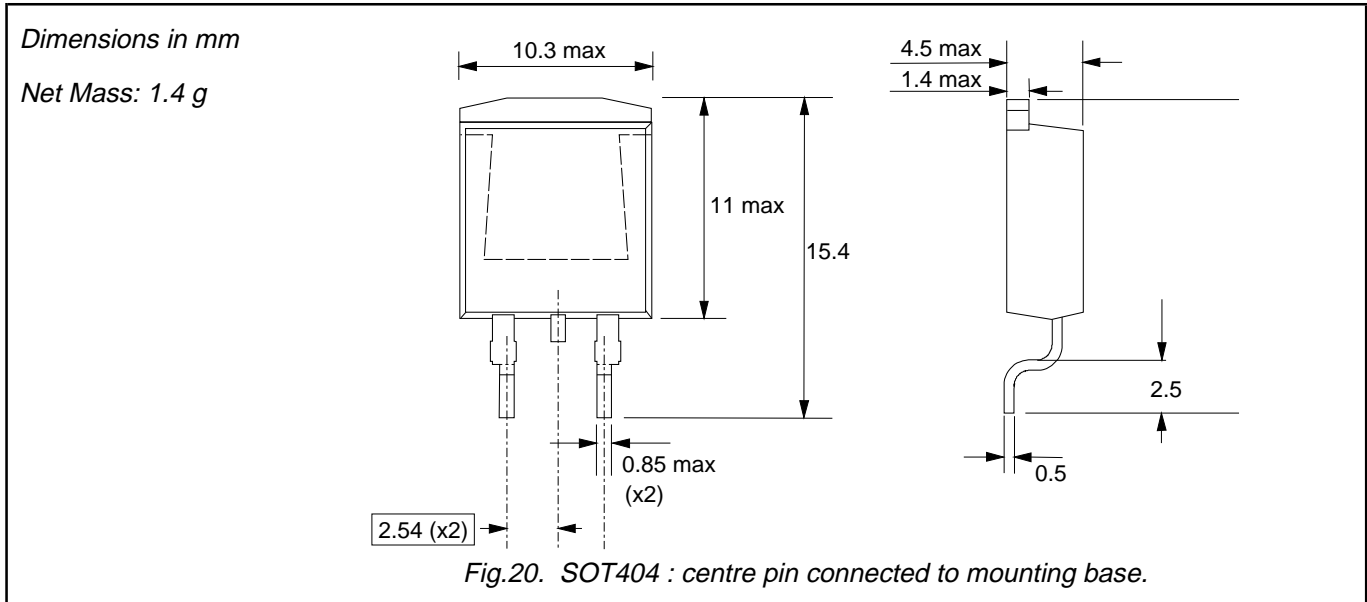

MOUNTING INSTRUCTIONS

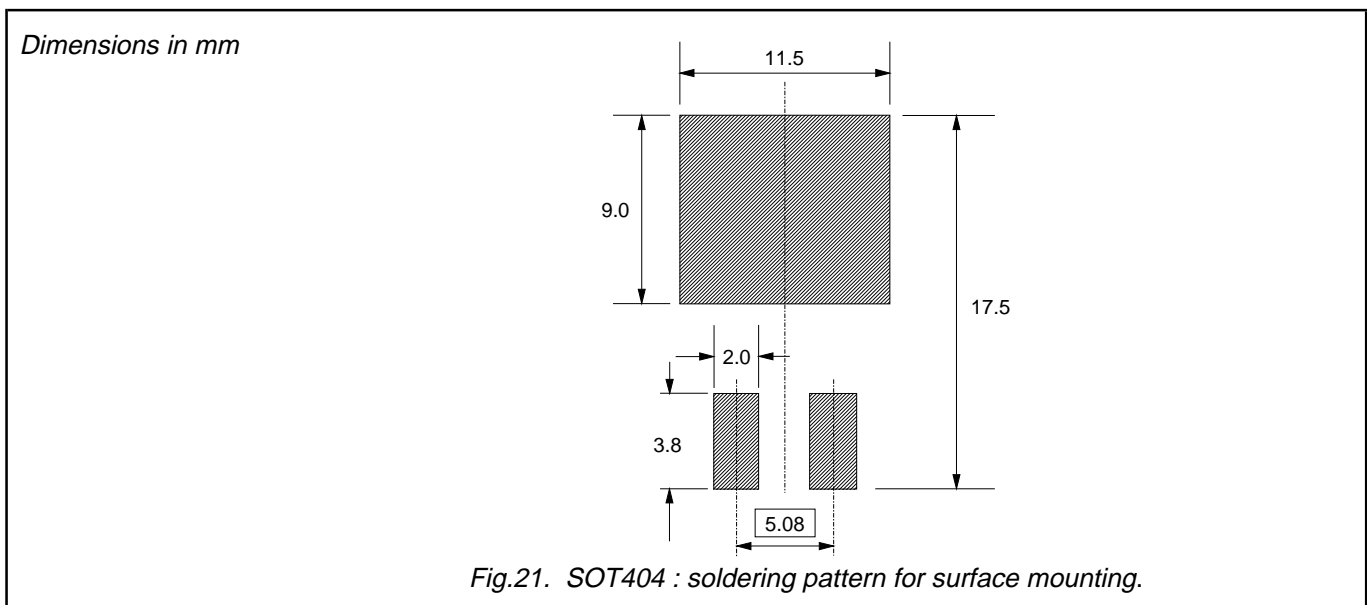

Notes

1. Observe the general handling precautions for electrostatic-discharge sensitive devices (ESDs) to prevent damage to MOS gate oxide.
2. Epoxy meets UL94 V0 at 1/8".

PowerMOS transistors Avalanche energy rated

PHP3N60E, PHB3N60E

DEFINITIONS

Data sheet status	
Objective specification	This data sheet contains target or goal specifications for product development.
Preliminary specification	This data sheet contains preliminary data; supplementary data may be published later.
Product specification	This data sheet contains final product specifications.
Limiting values	
Limiting values are given in accordance with the Absolute Maximum Rating System (IEC 134). Stress above one or more of the limiting values may cause permanent damage to the device. These are stress ratings only and operation of the device at these or at any other conditions above those given in the Characteristics sections of this specification is not implied. Exposure to limiting values for extended periods may affect device reliability.	
Application information	
Where application information is given, it is advisory and does not form part of the specification.	
© Philips Electronics N.V. 1998	
All rights are reserved. Reproduction in whole or in part is prohibited without the prior written consent of the copyright owner.	
The information presented in this document does not form part of any quotation or contract, it is believed to be accurate and reliable and may be changed without notice. No liability will be accepted by the publisher for any consequence of its use. Publication thereof does not convey nor imply any license under patent or other industrial or intellectual property rights.	

LIFE SUPPORT APPLICATIONS

These products are not designed for use in life support appliances, devices or systems where malfunction of these products can be reasonably expected to result in personal injury. Philips customers using or selling these products for use in such applications do so at their own risk and agree to fully indemnify Philips for any damages resulting from such improper use or sale.