

**TrenchMOS™ transistor
Logic level FET**

PHN1011

FEATURES

- 'Trench' technology
- Low on-state resistance
- Fast switching
- High thermal cycling performance
- Low-profile surface mount package
- Logic level compatible

SYMBOL

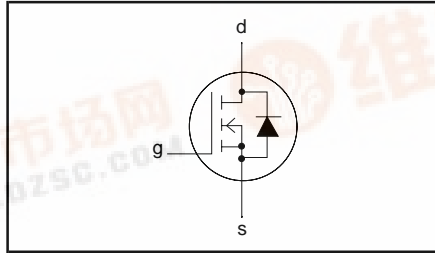

QUICK REFERENCE DATA

$V_{DSS} = 25\text{ V}$
$I_D = 11\text{ A}$
$R_{DS(ON)} \leq 11\text{ m}\Omega (V_{GS} = 10\text{ V})$
$R_{DS(ON)} \leq 13.5\text{ m}\Omega (V_{GS} = 5\text{ V})$

GENERAL DESCRIPTION

N-channel enhancement mode logic level field-effect power transistor in a surface mounting plastic package using 'trench' technology. The combination of very low on-state resistance and low switching losses make this device the optimum choice in high speed computer motherboard d.c. to d.c. converters.

The PHN1011 is supplied in the SOT96-1 (SO8) surface mounting package

PINNING

PIN	DESCRIPTION
1-3	source
4	gate
5-8	drain

SOT96-1 (SO8)

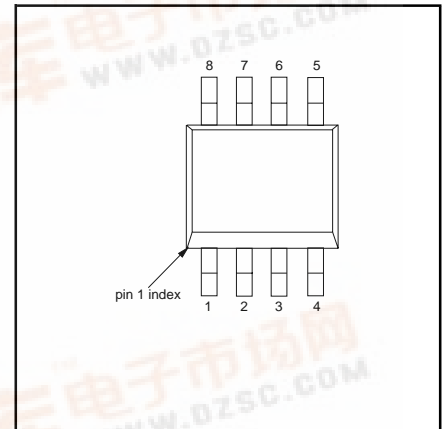

LIMITING VALUES

Limiting values in accordance with the Absolute Maximum System (IEC 134)

SYMBOL	PARAMETER	CONDITIONS	MIN.	MAX.	UNIT
V_{DSS}	Drain-source voltage	$T_j = 25\text{ }^\circ\text{C}$ to $150\text{ }^\circ\text{C}$	-	25	V
V_{DGR}	Drain-gate voltage	$T_j = 25\text{ }^\circ\text{C}$ to $150\text{ }^\circ\text{C}$; $R_{GS} = 20\text{ k}\Omega$	-	25	V
V_{GS}	Gate-source voltage (DC)	-	-	± 15	V
V_{GSM}	Gate-source voltage (pulse peak value)	-	-	± 20	V
I_D	Drain current ($t_p \leq 10\text{ s}$)	$T_a = 25\text{ }^\circ\text{C}$	-	11	A
		$T_a = 70\text{ }^\circ\text{C}$	-	9	A
I_{DM}	Drain current (pulse peak value)	$T_a = 25\text{ }^\circ\text{C}$	-	44	A
P_{tot}	Total power dissipation	$T_a = 25\text{ }^\circ\text{C}$	-	2.5	W
		$T_a = 70\text{ }^\circ\text{C}$	-	1.6	W
T_j, T_{stg}	Operating junction and storage temperature	-	- 55	150	$^\circ\text{C}$

THERMAL RESISTANCES

SYMBOL	PARAMETER	CONDITIONS	TYP.	MAX.	UNIT
$R_{th\ j-a}$	Thermal resistance junction to ambient	Surface mounted, FR4 board, $t \leq 10\text{ sec}$	-	50	K/W
$R_{th\ j-c}$	Thermal resistance junction to ambient	Surface mounted, FR4 board	150	-	K/W



TrenchMOS™ transistor

Logic level FET

PHN1011

ELECTRICAL CHARACTERISTICS

$T_j = 25^\circ\text{C}$ unless otherwise specified

SYMBOL	PARAMETER	CONDITIONS	MIN.	TYP.	MAX.	UNIT
$V_{(BR)DSS}$	Drain-source breakdown voltage	$V_{GS} = 0\text{ V}; I_D = 0.25\text{ mA};$ $T_j = -55^\circ\text{C}$	25	-	-	V
$V_{GS(TO)}$	Gate threshold voltage	$V_{DS} = V_{GS}; I_D = 1\text{ mA}$ $T_j = 150^\circ\text{C}$	1	1.5	2	V
$R_{DS(ON)}$	Drain-source on-state resistance	$V_{GS} = 10\text{ V}; I_D = 10\text{ A}$ $V_{GS} = 5\text{ V}; I_D = 5\text{ A}$ $V_{GS} = 5\text{ V}; I_D = 5\text{ A}; T_j = 150^\circ\text{C}$ $T_j = -55^\circ\text{C}$	-	9	11	mΩ
g_{fs}	Forward transconductance	$V_{DS} = 25\text{ V}; I_D = 10\text{ A}$	12	36	-	S
I_{GSS}	Gate source leakage current	$V_{GS} = \pm 5\text{ V}; V_{DS} = 0\text{ V}$	-	10	100	nA
I_{DSS}	Zero gate voltage drain current	$V_{DS} = 25\text{ V}; V_{GS} = 0\text{ V};$ $T_j = 150^\circ\text{C}$	-	0.05	10	μA
$Q_{g(tot)}$	Total gate charge	$I_D = 25\text{ A}; V_{DD} = 15\text{ V}; V_{GS} = 5\text{ V}$	-	26	-	nC
Q_{gs}	Gate-source charge		-	6	-	nC
Q_{gd}	Gate-drain (Miller) charge		-	9.4	-	nC
$t_{d\ on}$	Turn-on delay time	$V_{DD} = 15\text{ V}; I_D = 25\text{ A};$	-	7	15	ns
t_r	Turn-on rise time	$V_{GS} = 10\text{ V}; R_G = 5\ \Omega$	-	50	75	ns
$t_{d\ off}$	Turn-off delay time	Resistive load	-	82	120	ns
t_f	Turn-off fall time		-	59	75	ns
L_d	Internal drain inductance	Drain leads to centre of die	-	1	-	nH
L_s	Internal source inductance	Source leads to source bond pad	-	3	-	nH
C_{iss}	Input capacitance	$V_{GS} = 0\text{ V}; V_{DS} = 20\text{ V}; f = 1\text{ MHz}$	-	1700	-	pF
C_{oss}	Output capacitance		-	475	-	pF
C_{rss}	Feedback capacitance		-	300	-	pF

REVERSE DIODE LIMITING VALUES AND CHARACTERISTICS

$T_j = 25^\circ\text{C}$ unless otherwise specified

SYMBOL	PARAMETER	CONDITIONS	MIN.	TYP.	MAX.	UNIT
I_S	Continuous source current (body diode)	$T_a = 25^\circ\text{C}; t_p \leq 10\text{ s}$	-	-	11	A
I_{SM}	Pulsed source current (body diode)		-	-	44	A
V_{SD}	Diode forward voltage	$I_F = 10\text{ A}; V_{GS} = 0\text{ V}$	-	0.95	1.2	V
t_{rr}	Reverse recovery time	$I_F = 10\text{ A}; -dI_F/dt = 100\text{ A}/\mu\text{s};$	-	83	-	ns
Q_{rr}	Reverse recovery charge	$V_{GS} = 0\text{ V}; V_R = 25\text{ V}$	-	0.1	-	μC

TrenchMOS™ transistor
Logic level FET

PHN1011

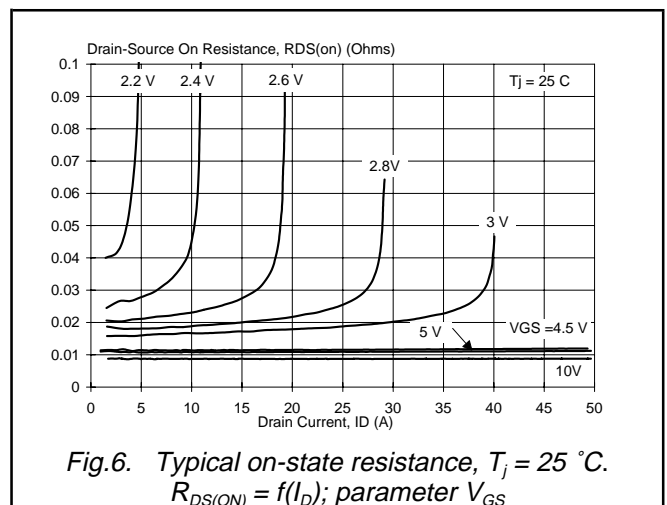
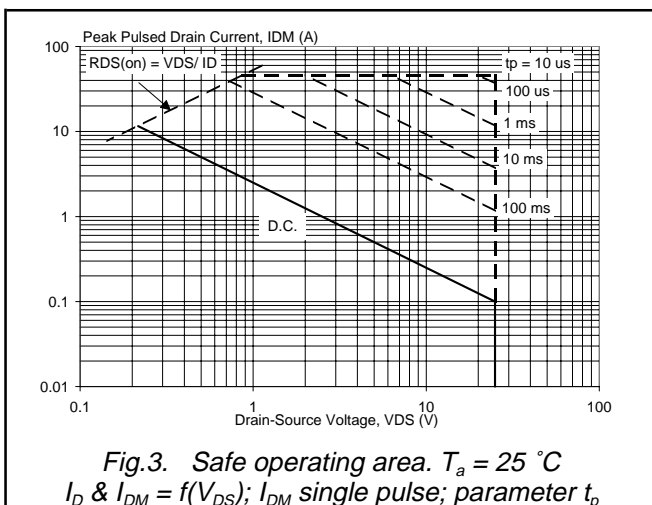
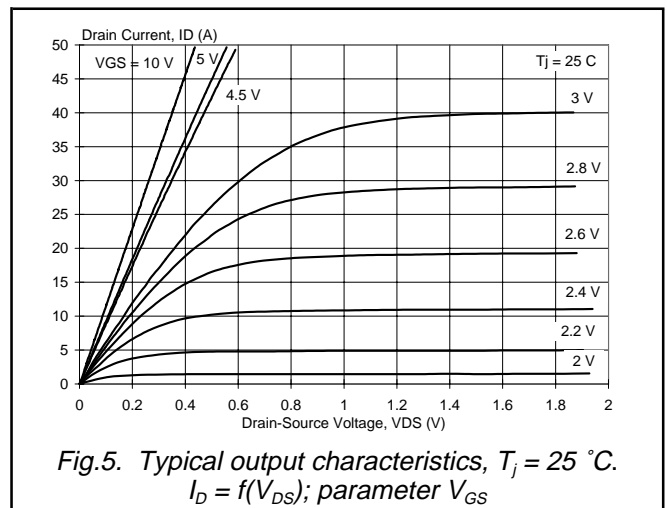
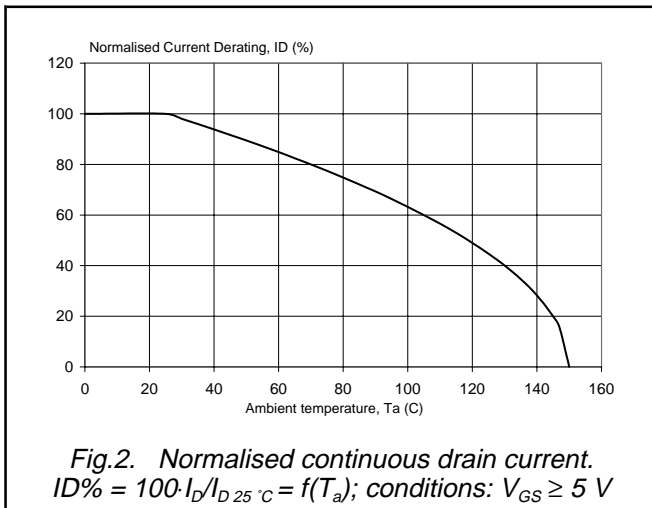
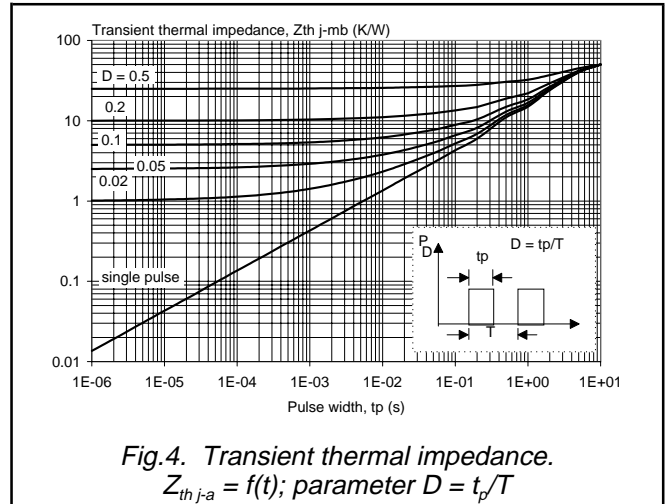
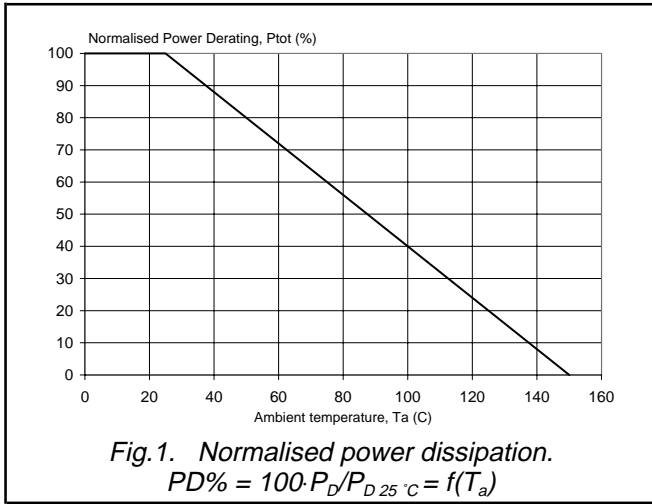

TrenchMOS™ transistor
Logic level FET

PHN1011

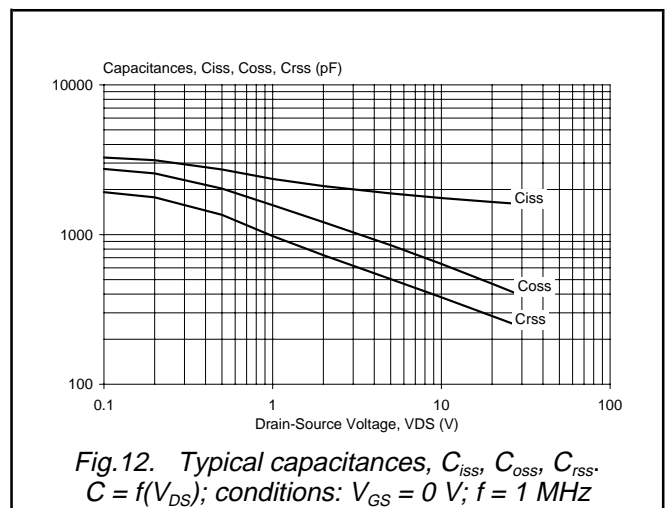
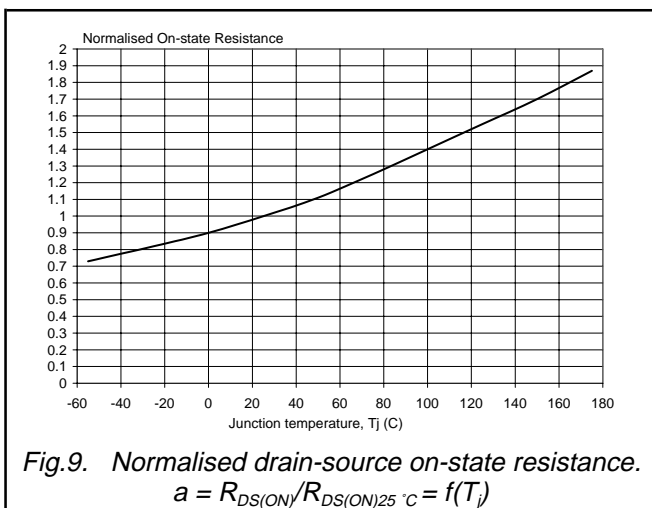
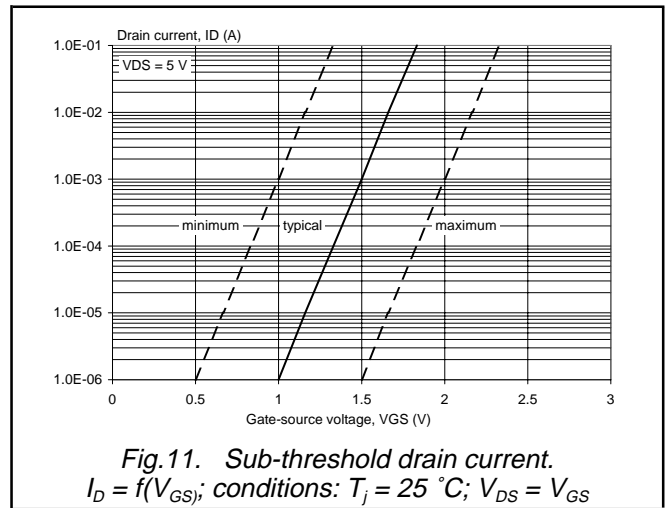
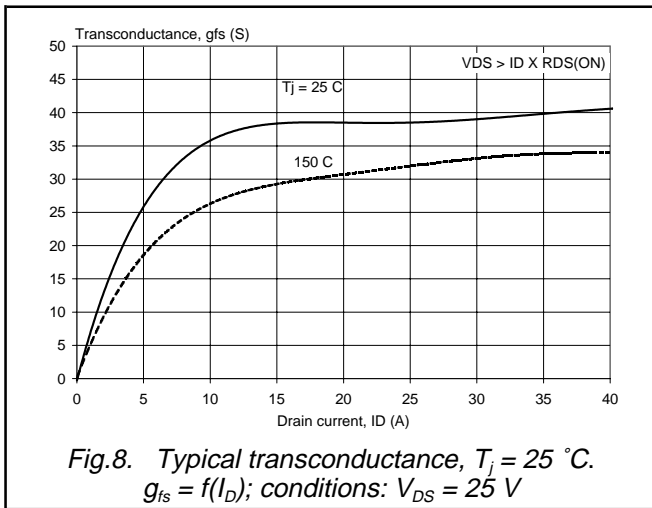
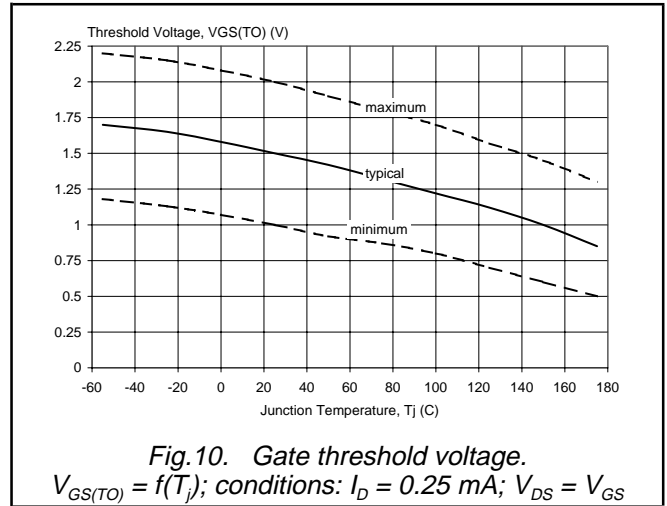
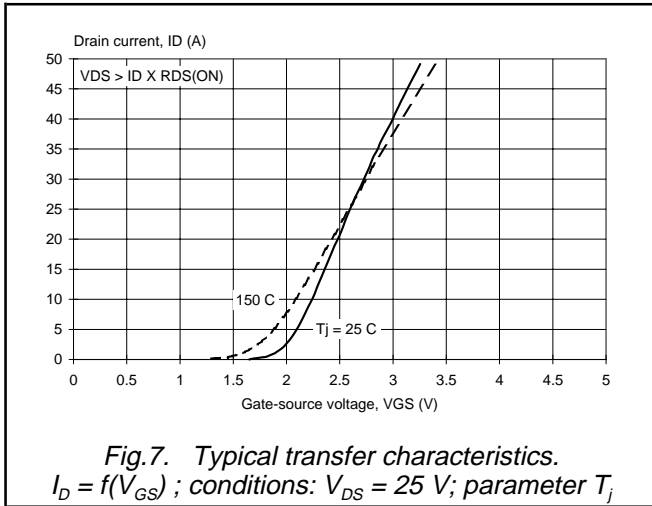

TrenchMOS™ transistor
Logic level FET

PHN1011

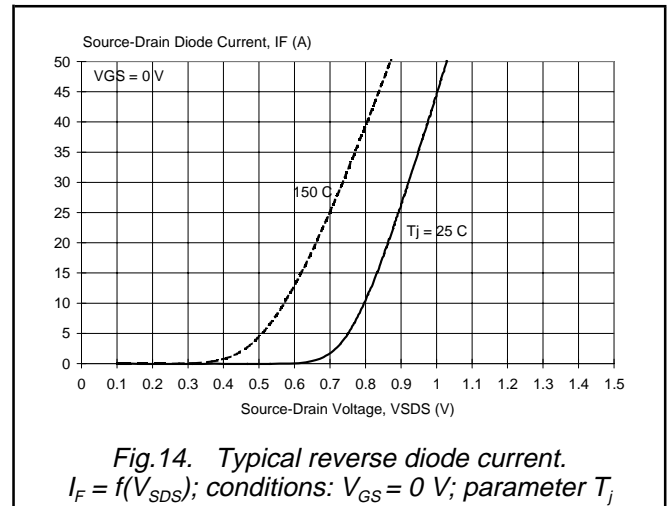
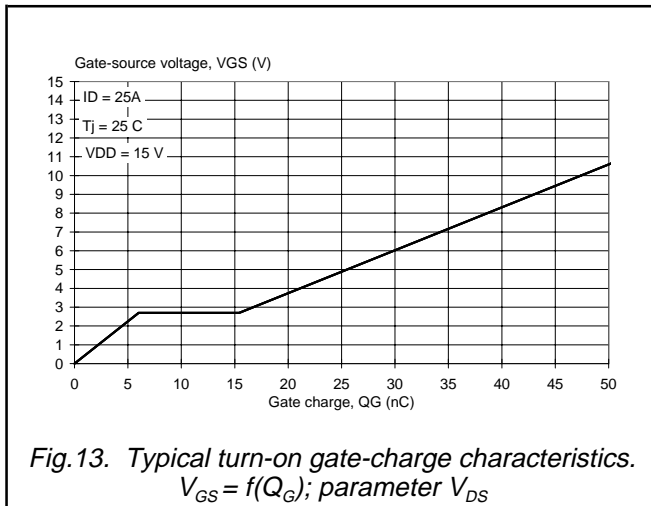

TrenchMOS™ transistor
Logic level FET

PHN1011

MECHANICAL DATA

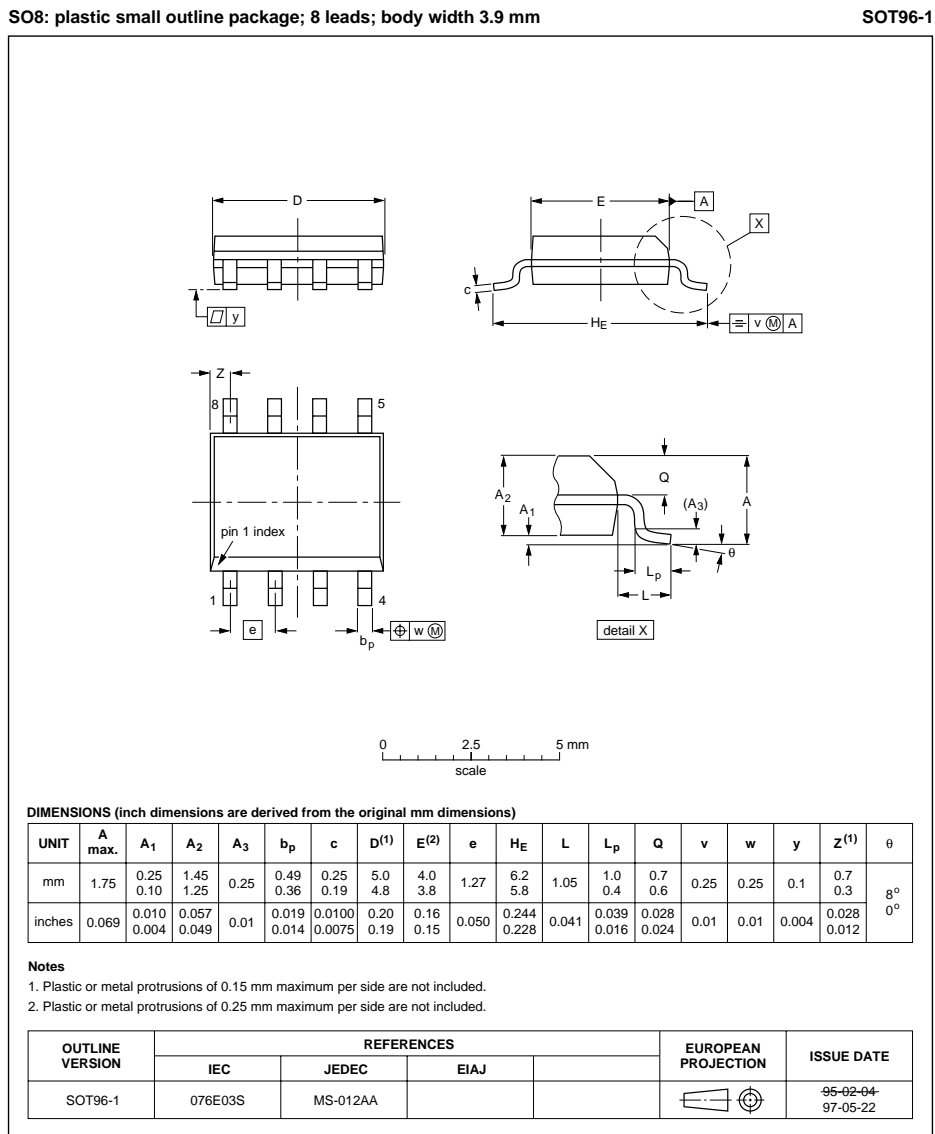

Fig. 15. SOT96 surface mounting package.

Notes

1. This product is supplied in anti-static packaging. The gate-source input must be protected against static discharge during transport or handling.
2. Refer to Integrated Circuit Packages, Data Handbook IC26.
3. Epoxy meets UL94 V0 at 1/8".

TrenchMOS™ transistor Logic level FET

PHN1011

DEFINITIONS

Data sheet status	
Objective specification	This data sheet contains target or goal specifications for product development.
Preliminary specification	This data sheet contains preliminary data; supplementary data may be published later.
Product specification	This data sheet contains final product specifications.
Limiting values	
Limiting values are given in accordance with the Absolute Maximum Rating System (IEC 134). Stress above one or more of the limiting values may cause permanent damage to the device. These are stress ratings only and operation of the device at these or at any other conditions above those given in the Characteristics sections of this specification is not implied. Exposure to limiting values for extended periods may affect device reliability.	
Application information	
Where application information is given, it is advisory and does not form part of the specification.	
© Philips Electronics N.V. 1999	
All rights are reserved. Reproduction in whole or in part is prohibited without the prior written consent of the copyright owner.	
The information presented in this document does not form part of any quotation or contract, it is believed to be accurate and reliable and may be changed without notice. No liability will be accepted by the publisher for any consequence of its use. Publication thereof does not convey nor imply any license under patent or other industrial or intellectual property rights.	

LIFE SUPPORT APPLICATIONS

These products are not designed for use in life support appliances, devices or systems where malfunction of these products can be reasonably expected to result in personal injury. Philips customers using or selling these products for use in such applications do so at their own risk and agree to fully indemnify Philips for any damages resulting from such improper use or sale.