

PNA4S11M Series (PNA4S11M/4S12M/4S13M/4S14M)

Bipolar Integrated Circuit with Photodetection Function

For infrared remote control systems

■ Features

- Surface-mounting type for reflow soldering
- Space saved by miniaturization
- Ready for automatic mounting

■ Absolute Maximum Ratings (Ta = 25°C)

Parameter	Symbol	Ratings	Unit
Power supply voltage	V _{CC}	-0.5 to +7	V
Power dissipation	P _D	200	mW
Operating ambient temperature	T _{opr}	-20 to +60	°C
Storage temperature	T _{stg}	-30 to +70	°C

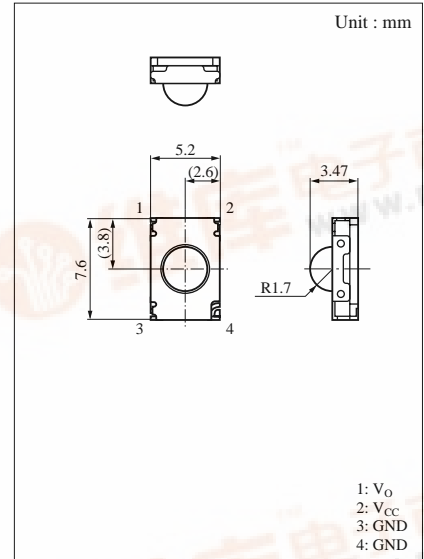

■ Main Characteristics (Ta = 25°C V_{CC} = 5V)

Parameter	Symbol	Conditions	min	typ	max	Unit
Operating supply voltage	V _{CC}		4.7	5.0	5.3	V
Current consumption	I _{CC}	No signal condition	1.8	2.4	3.0	mA
Maximum reception distance	L _{max} ^{*1}		7.0			m
Low-level output voltage	V _{OL} ^{*2}	L≤7.0m, 10L=400μA		0.35	0.5	V
High-level output voltage	V _{OH}	No signal condition	4.8	5.0	V _{CC}	V
Low-level pulse width	T _{WL} ^{*1}	L=7.0m, 16Pulse	200	400	600	μs
High-level pulse width	T _{WH} ^{*1}	L=7.0m, 16Pulse	200	400	600	μs
Carrier frequency	PNA4S11M	f ₀		36.7		kHz
	PNA4S12M			38.0		
	PNA4S13M			40.0		
	PNA4S14M			56.9		

*1 Fig.1 burst wave, L=L_{max}, 16 pulses

*2 Fig.2 continuous wave, L≤L_{max}

Carrier wave : f₀

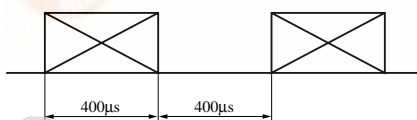

Fig.1

Carrier wave : f₀

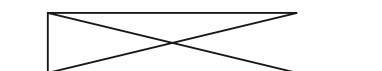
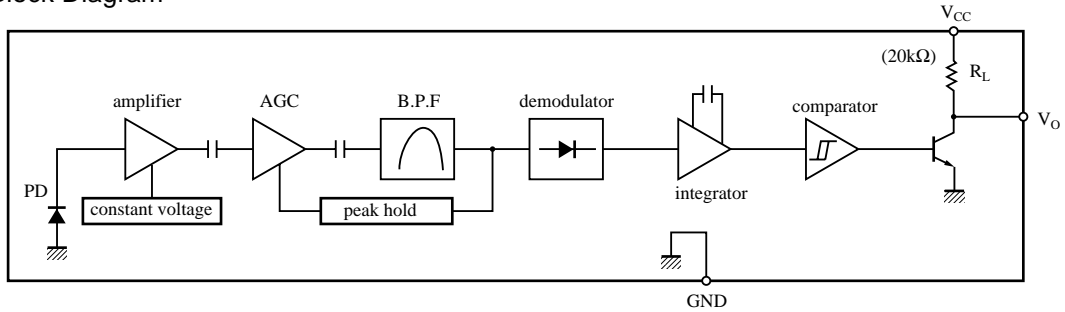
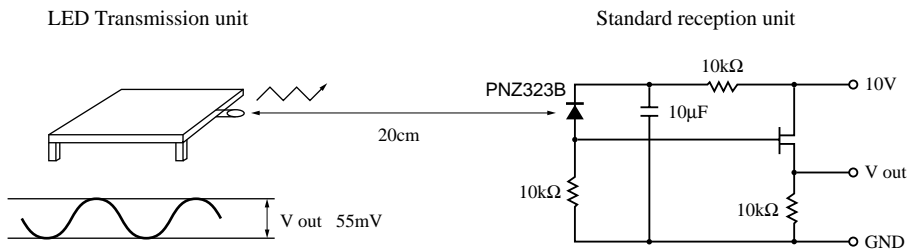

Fig.2

■ Block Diagram



■ Panasonic Transmitter Specifications



- The light output of the LED transmission unit is adjusted so that the transmission output (V_{out}) of the standard reception unit will be 55 mV when the transmission waveform (duty = 50%) is output from the LED transmission unit. Here, infrared sensitivity (SIR) of PNZ323B is $0.53 \mu A$ when emission illuminance (H) is $12.45 \mu W/cm^2$.
- The maximum reception distance under these specifications is an assurance that T_{WH} and T_{WL} values will be within the tolerance ranges when 16 consecutive pulses of an optical output equivalent to the maximum reception distance are transmitted by the above transmission unit (The maximum reception distance is measured in the dark without external disturbance noise.)

L max — Ta

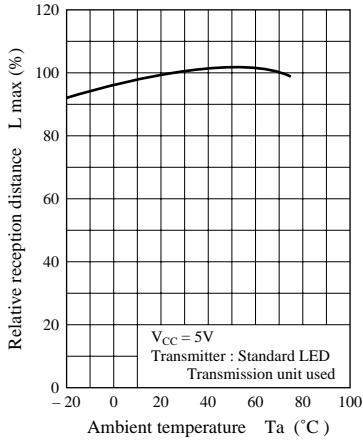

B.P.F frequency characteristics (PNA4S12M)*

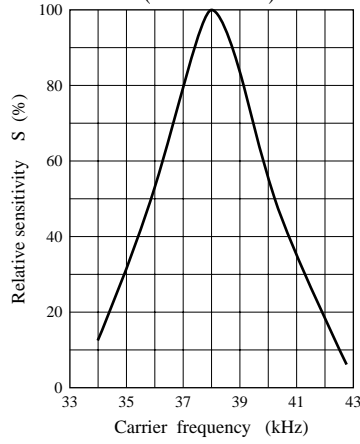

* The peaks for PNA4S11M, PNA4S13M, and PNA4S14M are all f_0 .

Spectral sensitivity characteristics

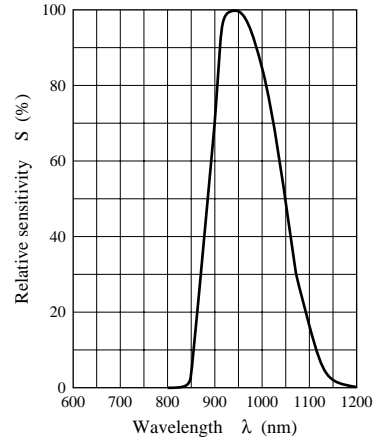

Directivity characteristics

