

PQ05RH1/PQ05RH11 Series

1.5A Output, Low Power-Loss Voltage Regulators

■ Features

- Low power-loss (Dropout voltage : MAX. 0.5V)
- Compact resin full-mold package
- Built-in ON/OFF control terminal
- High-precision output (Output voltage precision : $\pm 2.5\%$) (PQ05RH11 Series)

■ Applications

- Series power supply for various electronic equipment such as VCRs and OA equipment.

■ Model Line-ups

Output voltage	5V Output	9V Output	12V Output
Output voltage precision: $\pm 5\%$	PQ05RH1	PQ09RH1	PQ12RH1
Output voltage precision: $\pm 2.5\%$	PQ05RH11	PQ09RH11	PQ12RH11

■ Equivalent Circuit Diagram

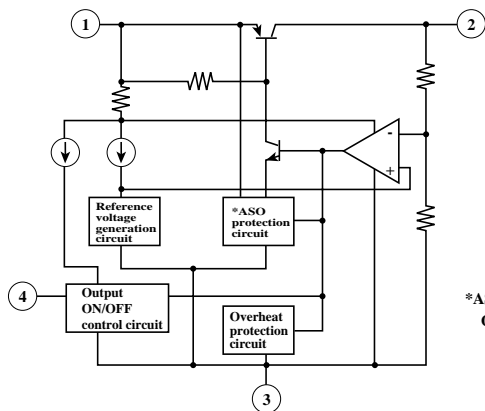

*ASO:Area of Safety Operation

■ Outline Dimensions

(Unit : mm)

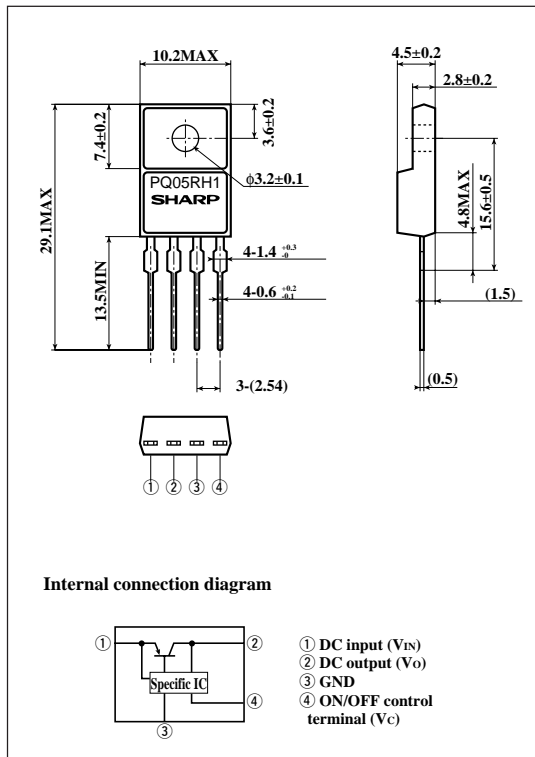

· Please refer to the chapter "Handling Precautions".

■ Absolute Maximum Ratings

($T_a=25^{\circ}\text{C}$)

Parameter	Symbol	Rating	Unit
*1 Input voltage	V_{IN}	35	V
*1 ON/OFF control terminal voltage	V_C	35	V
Output current	I_o	1.5	A
Power dissipation(No heat sink)	P_{D1}	1.5	W
Power dissipation(With infinite heat sink)	P_{D2}	18	W
*2 Junction temperature	T_j	150	$^{\circ}\text{C}$
Operating temperature	T_{opr}	-20 to +80	$^{\circ}\text{C}$
Storage temperature	T_{stg}	-40 to +150	$^{\circ}\text{C}$
Soldering temperature	T_{sol}	260(For 10s)	$^{\circ}\text{C}$

*1 All are open except GND and applicable terminals.

*2 Overheat protection may operate at $125 < T_j < 150^{\circ}\text{C}$.

■ Electrical Characteristics

(Unless otherwise specified, condition shall be $I_o=0.5\text{A}$, $T_a=25^{\circ}\text{C}$ *)

Parameter	Symbol	Conditions	MIN.	TYP.	MAX.	Unit	
Output voltage	V_o	-	PQ05RH1	4.75	5.0	5.25	V
			PQ09RH1	8.55	9.0	9.45	
			PQ12RH1	11.4	12.0	12.6	
			PQ05RH11	4.88	5.0	5.12	
			PQ09RH11	8.78	9.0	9.22	
			PQ12RH11	11.7	12.0	12.3	
Load regulation	R_{egL}	$I_o=5\text{mA}$ to 1.5A	-	0.3	2.0	%	
Line regulation	R_{egI}	*4	-	0.5	2.5	%	
Temperature coefficient of output voltage	T_cV_o	$T_j=0$ to 125°C	-	± 0.02	-	$\%/^{\circ}\text{C}$	
Ripple rejection	RR	Refer to Figs.2	45	55	-	dB	
Dropout voltage	V_{i-o}	*5	-	-	0.5	V	
ON-state voltage for control	$V_C(\text{ON})$	-	2.0	*6	-	V	
ON-state current for control	$I_C(\text{ON})$	$V_C=2.7\text{V}$	-	-	20	μA	
OFF-state voltage for control	$V_C(\text{OFF})$	-	-	-	0.8	V	
OFF-state current for control	$I_C(\text{OFF})$	$V_C=0.4\text{V}$	-	-	-0.4	mA	
Quiescent current	I_q	$I_o=0$	-	-	10	mA	

*3 PQ05RH1 series: $V_{IN}=7\text{V}$, PQ09RH1 series: $V_{IN}=15\text{V}$, PQ12RH1 series: $V_{IN}=18\text{V}$

*4 PQ05RH1/PQ05RH11: $V_{IN}=6$ to 12V

PQ09RH1/PQ09RH11: $V_{IN}=10$ to 25V

PQ12RH1/PQ12RH11: $V_{IN}=13$ to 29V

*5 Input voltage shall be the value when output voltage is 95% in comparison with the initial value.

*6 In case of opening control terminal ④, output voltage turns on.

Fig.1 Test Circuit

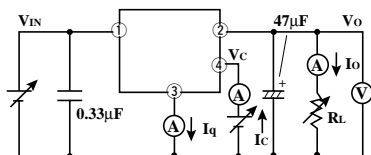
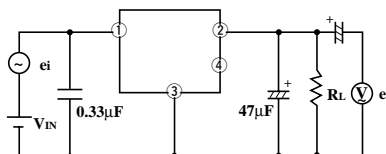

Fig.2 Test Circuit of Ripple Rejection



$f=120\text{Hz}$ (sine wave)

$e_i=0.5\text{V rms}$

$RR=20 \log (e_i/e_o)$

Fig.3 Power Dissipation vs. Ambient Temperature

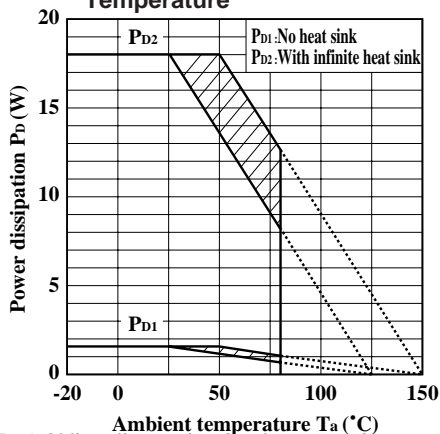

Note) Oblique line portion: Overheat protection may operate in this area.

Fig.5 Output Voltage Deviation vs. Junction Temperature (PQ05RH1/PQ05RH11)

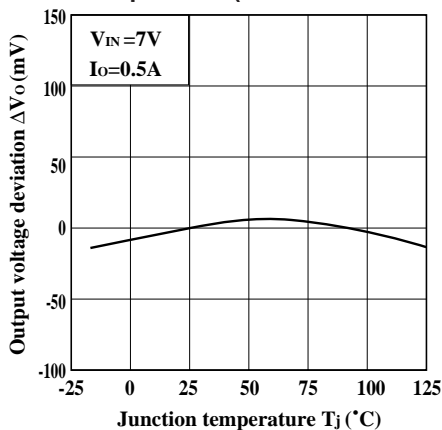

Fig.7 Output Voltage Deviation vs. Junction Temperature (PQ12RH1/PQ12RH11)

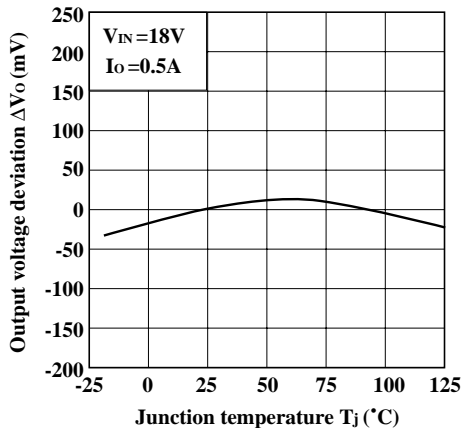

Fig.4 Overcurrent Protection Characteristics (Typical value)

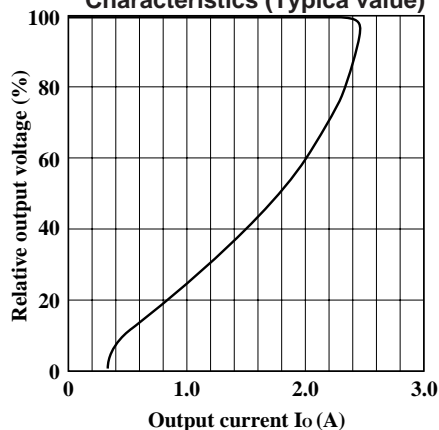

Fig.6 Output Voltage Deviation vs. Junction Temperature (PQ09RH1/PQ09RH11)

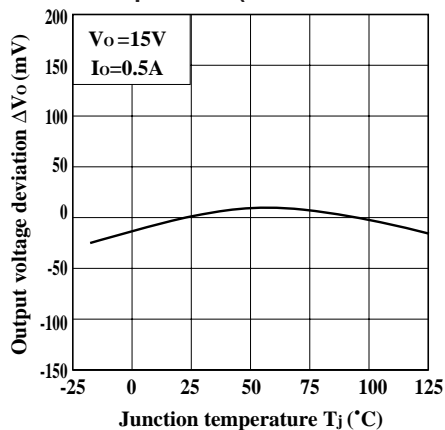

Fig.8 Output Voltage vs. Input Voltage (PQ05RH1/PQ05RH11)

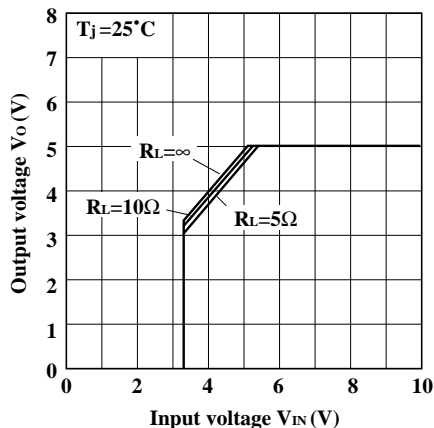

Fig.9 Output Voltage vs. Input Voltage (PQ09RH1/PQ09RH11)

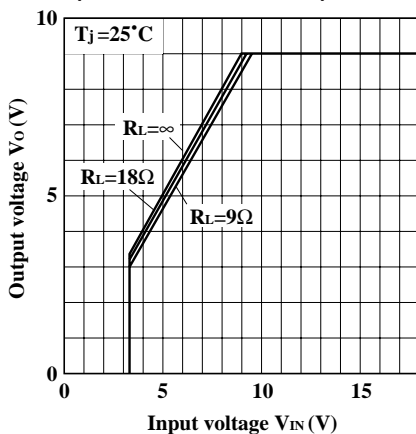

Fig.10 Output Voltage vs. Input Voltage (PQ12RH1/PQ12RH11)

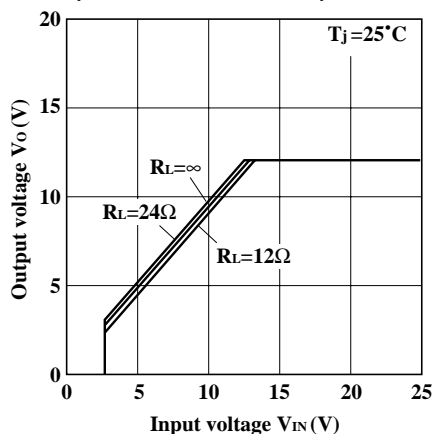

Fig.11 Circuit Operating Current vs. Input Voltage (PQ05RH1/PQ05RH11)

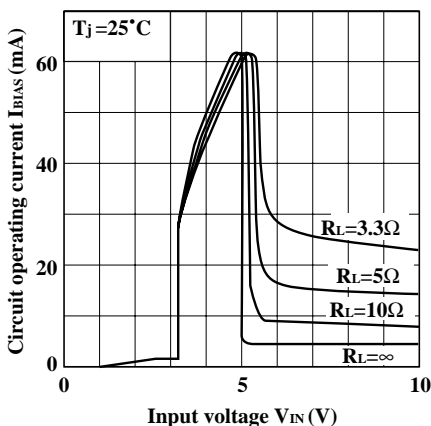

Fig.12 Circuit Operating Current vs. Input Voltage (PQ09RH1/PQ09RH11)

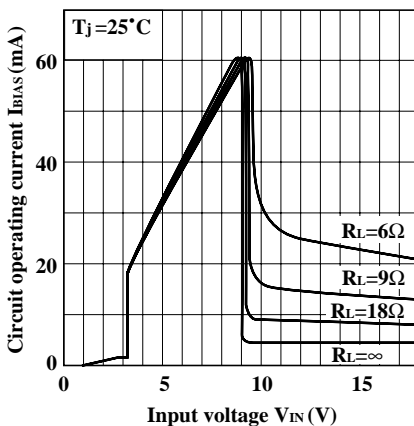

Fig.13 Circuit Operating Current vs. Input Voltage (PQ12RH1/PQ12RH11)

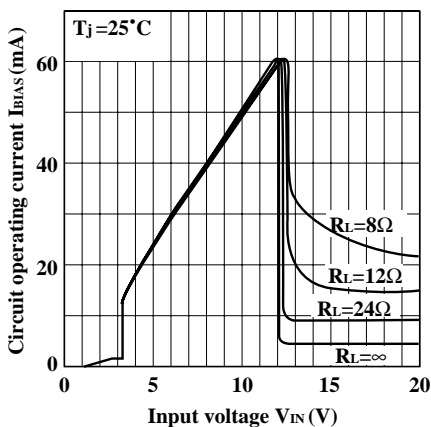

Fig.14 Dropout Voltage vs. Junction Temperature

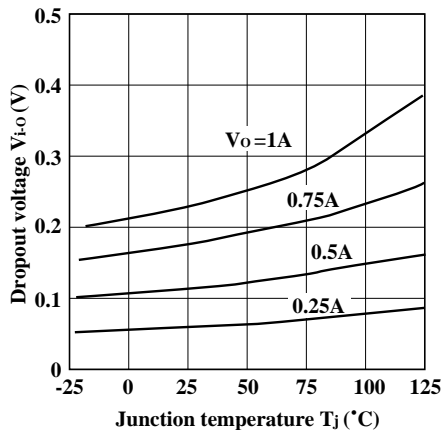

Fig.15 Quiescent Current vs. Junction Temperature

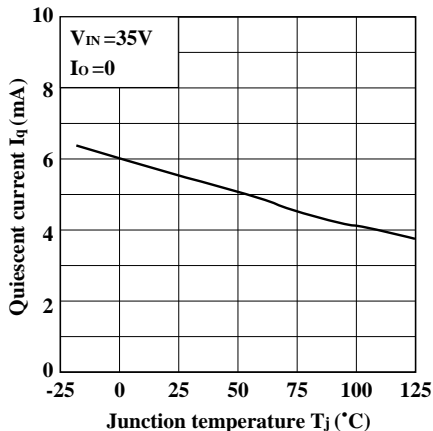

Fig.16 Repple Rejection vs. Input Ripple Frequency

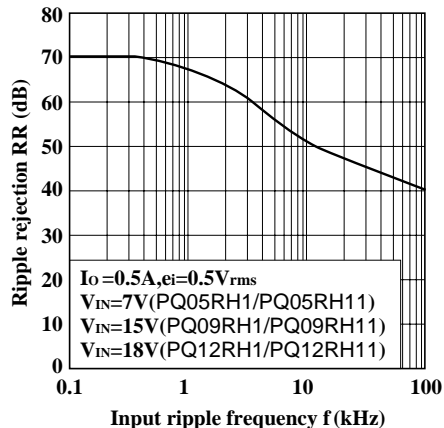

Fig.17 Ripple Rejection vs. Output Current

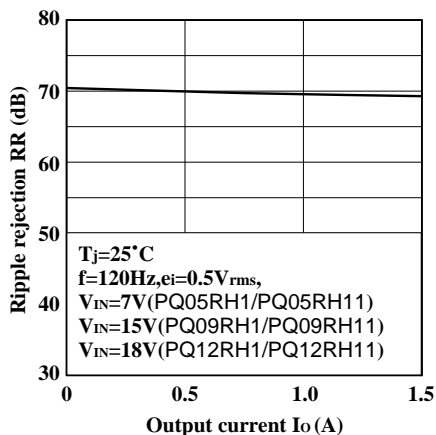
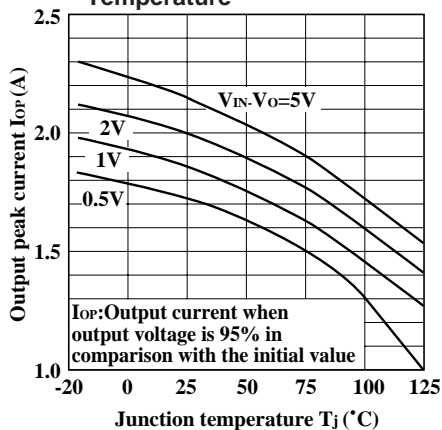
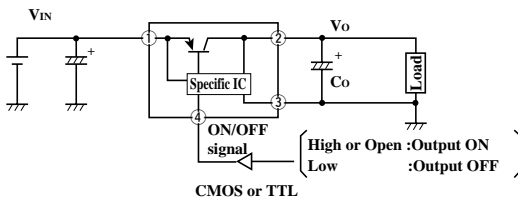

Fig.18 Output Peak Current vs. Junction Temperature



■ Typical Application



■ Model Line-ups for Lead Forming Type

Output voltage	5V Output	9V Output	12V Output
Output voltage precision:±5%	PQ05RH1A	PQ09RH1A	PQ12RH1A
Output voltage precision:±2.5%	PQ05RH1B	PQ09RH1B	PQ12RH1B

■ Outline Dimensions (PQ05RH1A/PQ05RH1B Series)

(Unit : mm)

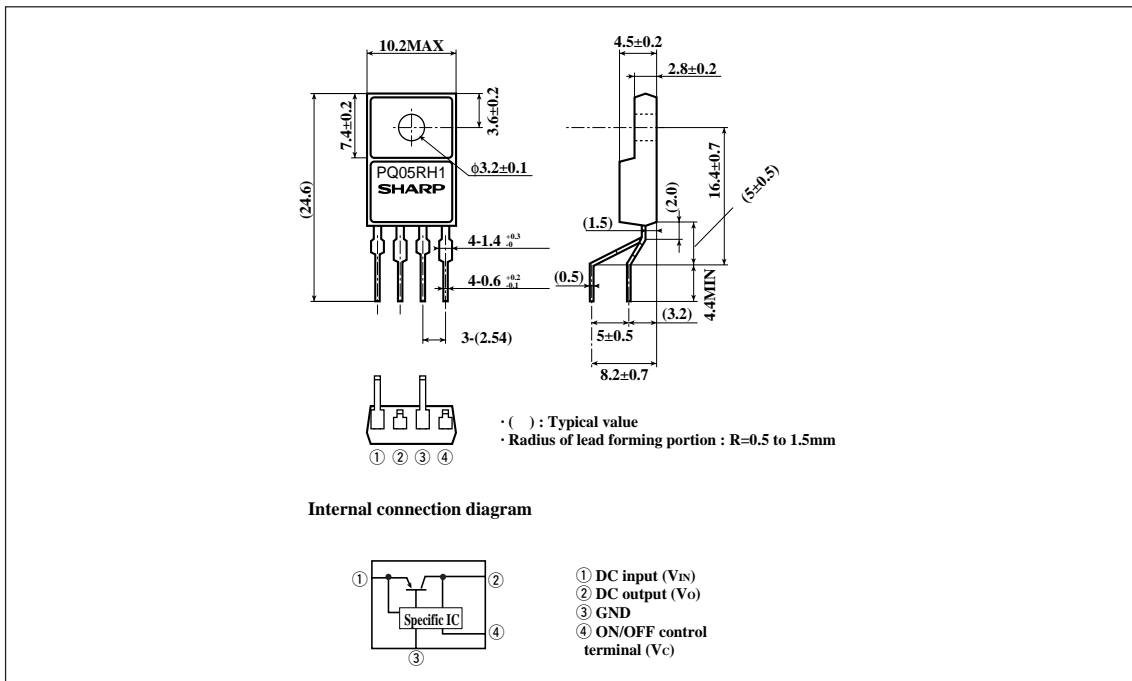

Note) The value of absolute maximum ratings and electrical characteristics is same as ones of PQ05RH1/11 series.