

8 PIN SOP 400 V BREAKDOWN VOLTAGE TRANSFER TYPE 2-CH OPTICAL COUPLED MOSFET

PS7241-1C

FEATURES

- **2 CHANNEL TYPE:**
1a + 1b Output
- **DESIGNED FOR AC/DC SWITCHING LINE CHANGER**
- **SMALL AND THIN PACKAGE:**
8 PIN SOP
- **LOW LED OPERATING CURRENT:**
 $I_F = 2 \text{ mA}$
- **LOW OFFSET VOLTAGE**
- **AVAILABLE IN TAPE AND REEL**

DESCRIPTION

PS7241-1C is a transfer type solid state relay containing normally open (N.O.) contact and normally closed (N.C.) contact on the output side.

This device is suitable for analog signal control because of its low offset and high linearity.

APPLICATIONS

- EXCHANGE EQUIPMENT
- MEASUREMENT EQUIPMENT
- FA/OA EQUIPMENT
- COMMUNICATIONS EQUIPMENT
- DAA (MODEM)

ELECTRICAL CHARACTERISTICS (T_A = 25°C)

PART NUMBER			PS7241-1C			
SYMBOLS	PARAMETERS	UNITS	MIN	TYP	MAX	
Diode	V _F	Forward Voltage, I _F = 10 mA		1.2	1.4	
	I _R	Reverse Current, V _R = 5 V	μA		5	
MOSFET	I _{Loff}	Off-State Leakage Current, N.O.: I _F = 0 mA, V _D = 400 V N.C.: I _F = 10 mA, V _D = 400 V	μA	0.03	1	
	C _{OUT}	Output Capacitance N.O.: V _D = 0 mA, f = 1.0 MHz N.C.: V _D = 0 mA, f = 1.0 MHz, I _F = 10 mA	pF/ch	65 185		
Coupled	I _{Fon}	LED On-state Current NO: I _L = 120 mA	mA		2.0	
	I _{Foff}	LED Off-state Current NC I _L = 120 mA				
	R _{on1}	On-State Resistance, N.O.: I _F = 10 mA, I _L = 10 mA N.C.: I _F = 0 mA, I _L = 10 mA		Ω	21	30
		R _{on2}	N.O.: I _F = 10 mA, I _L = 120 mA, t ≤ 10 ms N.C.: I _F = 0 mA, I _L = 120 mA, t ≤ 10 ms		Ω	16
	t _{ON} (N.O.) t _{ON} (N.C.)		Turn-On Time ¹ I _F = 10 mA, V _O = 5 V, PW ≥ 10 ms	ms	0.2	1.0
	t _{OFF} (N.O.) t _{OFF} (N.C.)	0.02			0.2	
	R _{I-O}	Isolation Resistance, V _{IN-OUT} = 1.0 kVDC	Ω	10 ⁹		
	C _{I-O}	Isolation Capacitance, V = 0 V, f = 1 MHz	pF/ch	0.4		

Note:

1. Test Circuit for Switching Time:

N.O. (Between Pin 5 and 6)

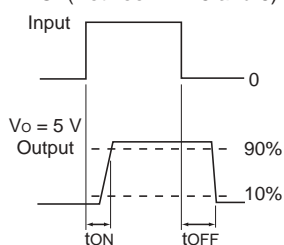

N.C. (Between Pin 7 and 8)

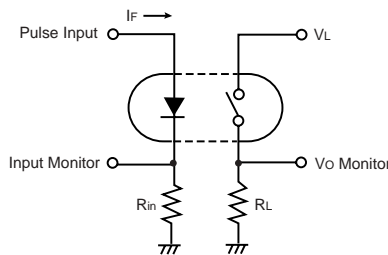
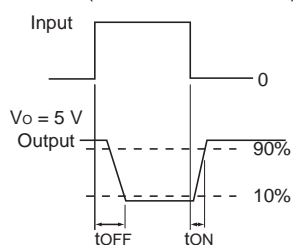

PS7241-1C

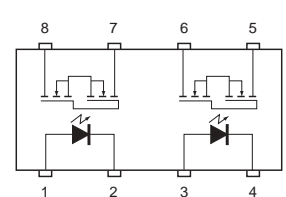

ABSOLUTE MAXIMUM RATINGS¹ (T_A = 25°C)

SYMBOLS	PARAMETERS	UNITS	RATINGS
Diode			
V _R	Reverse Voltage	V	5
I _F	Forward Current (DC)	mA	50
P _D	Power Dissipation	mW/ch	50
I _{F (Peak)}	Peak Forward Current ²	A	1
MOSFET			
V _L	Break Down Voltage	V	400
I _L	Continuous Load Current	mA	120
I _{LP}	Pulse Load Current ⁴ (AC/DC Current)	mA	200
P _D	Power Dissipation	mW/ch	180
Coupled			
BV	Isolation Voltage ³	Vr.m.s.	1500
P _T	Total Power Dissipation	mW	460
T _{STG}	Storage Temperature	°C	-40 to +100
T _A	Ambient Temperature	°C	-40 to +80

Notes:

1. Operation in excess of any one of these parameters may result in permanent damage.
2. PW = 100 μs, Duty Cycle = 1 %
3. AC voltage for 1 minute at T_A = 25 °C, RH = 60 % between input and output.
4. PW = 100 ms, 1 shot.

ORDERING INFORMATION

PART NUMBER	PACKAGE	PACKING STYLE
PS7241-1C	8 pin SOP	Magazine case 45 pcs
PS7241-1C-F3		Embossed tape 1500 pcs/reel
PS7241-1C-F4		

RECOMMENDED OPERATING CONDITIONS (T_A = 25 °C)

SYMBOL	PARAMETER	UNITS	MIN	TYP	MAX
I _F	LED Operating Current	mA	2	10	20
V _F	LED Off Voltage	V	0		0.5

OUTLINE DIMENSIONS (Units in mm)

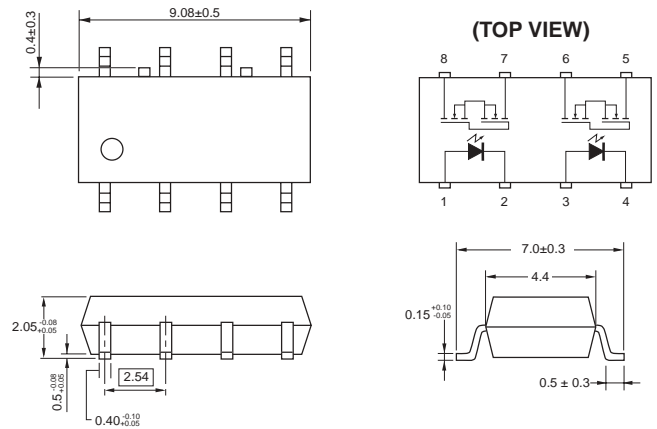

1. LED Anode
2. LED Cathode
3. LED Anode
4. LED Cathode
5. MOSFET (N.O.)
6. MOSFET (N.O.)
7. MOSFET (N.C.)
8. MOSFET (N.C.)

TYPICAL PERFORMANCE CURVES (T_A = 25 °C)

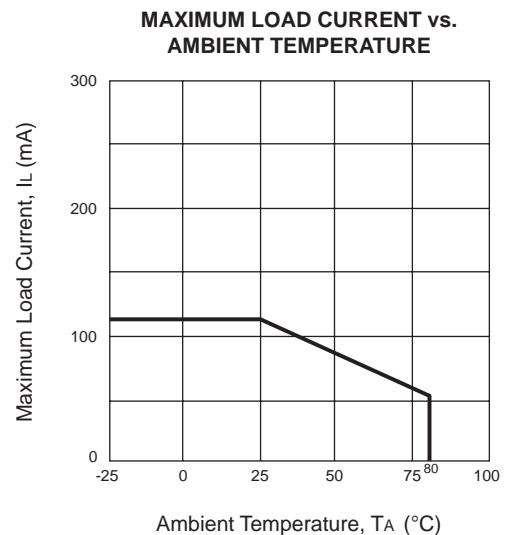
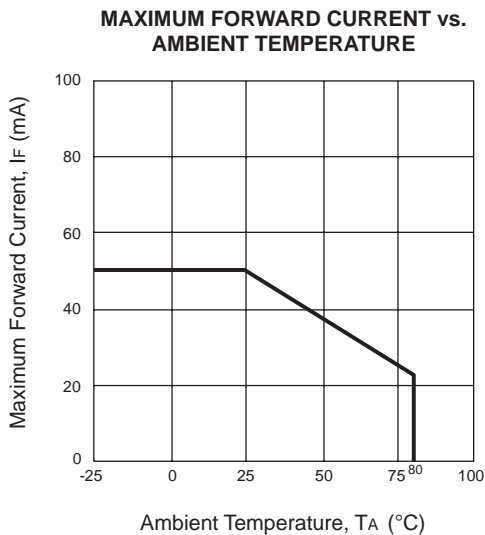

TYPICAL PERFORMANCE CURVES ($T_A = 25^\circ\text{C}$)

FORWARD VOLTAGE vs. AMBIENT TEMPERATURE

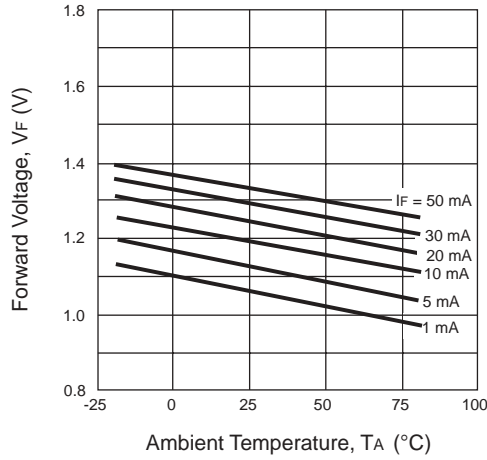

OUTPUT CAPACITANCE vs. APPLIED VOLTAGE

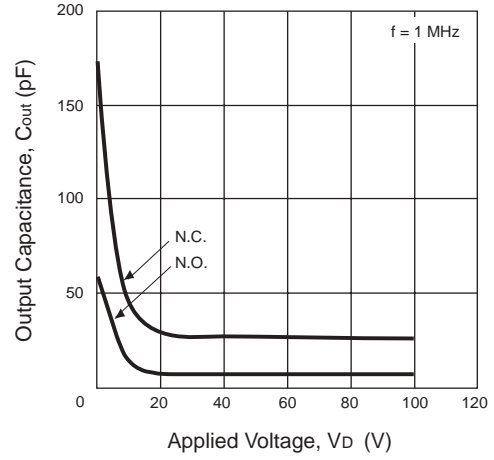

OFF-STATE LEAKAGE CURRENT vs. APPLIED VOLTAGE

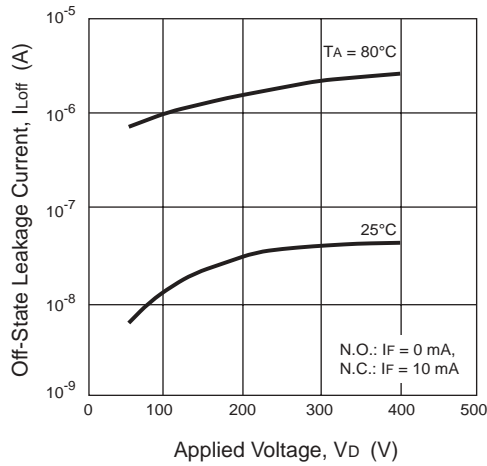

LOAD CURRENT vs. LOAD VOLTAGE

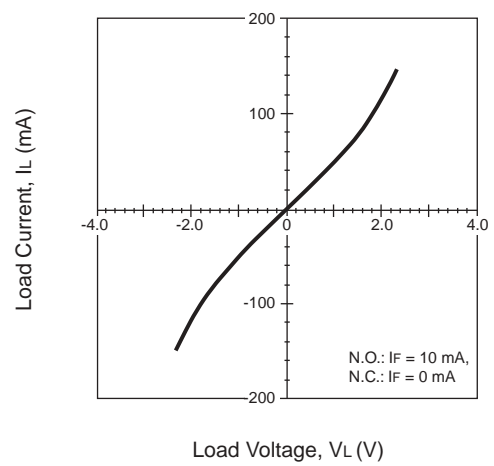

TURN-ON TIME vs. FORWARD CURRENT

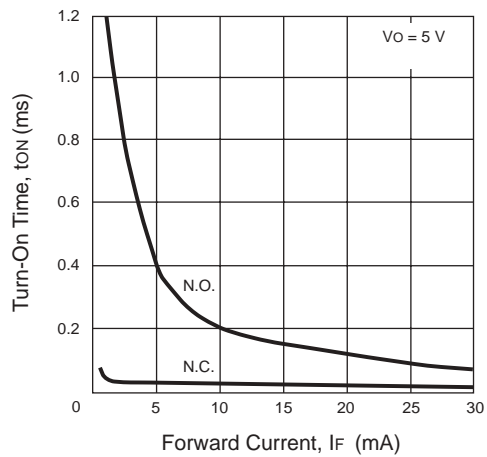

TURN-OFF TIME vs. FORWARD CURRENT

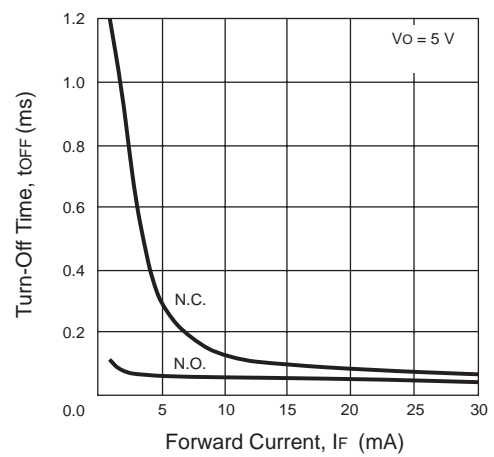

TYPICAL PERFORMANCE CURVES (TA = 25 °C)

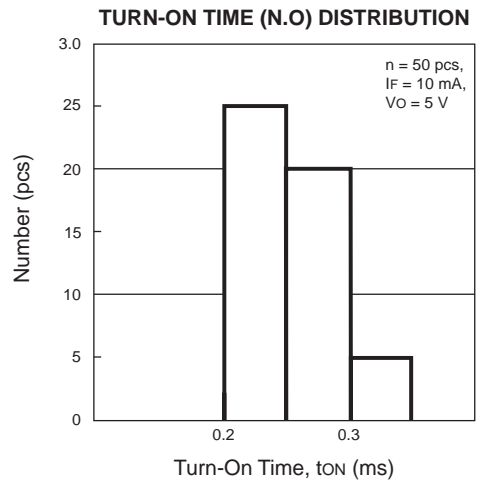
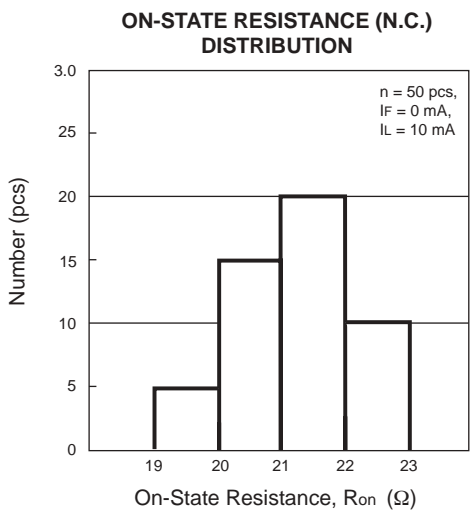
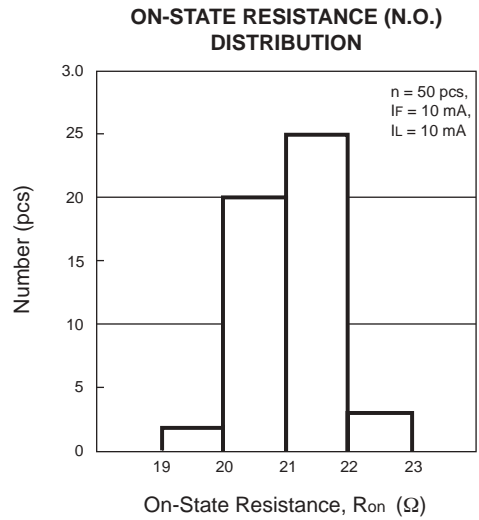
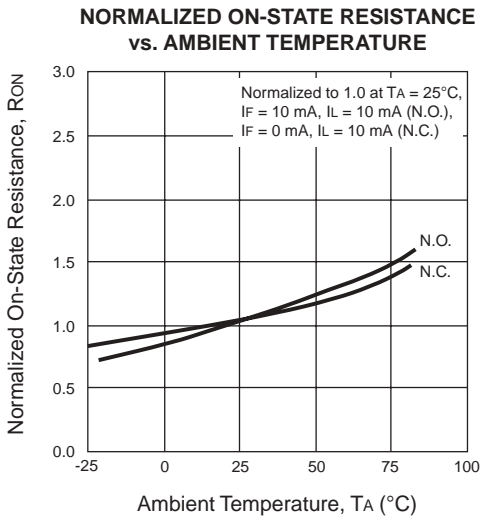
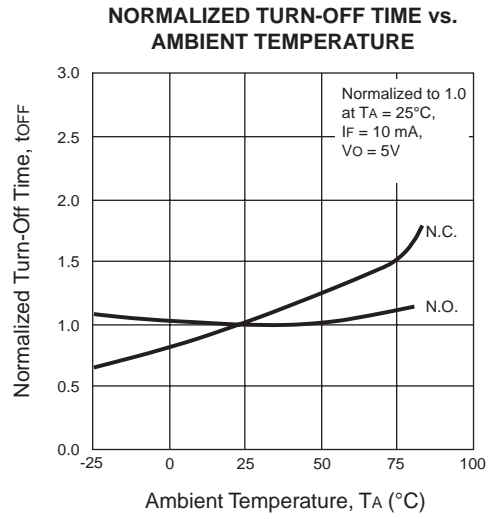
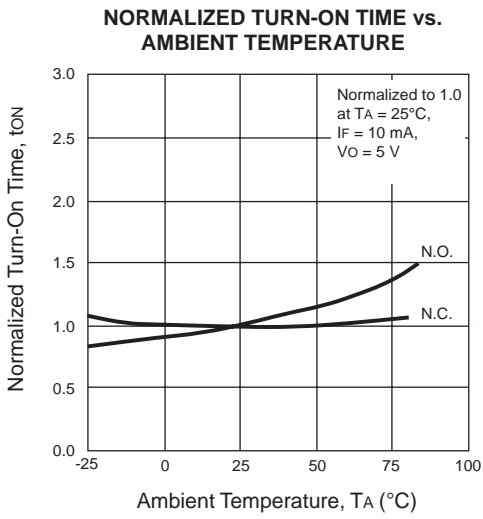

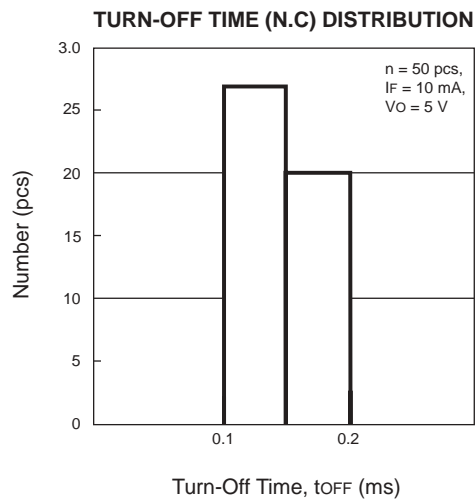
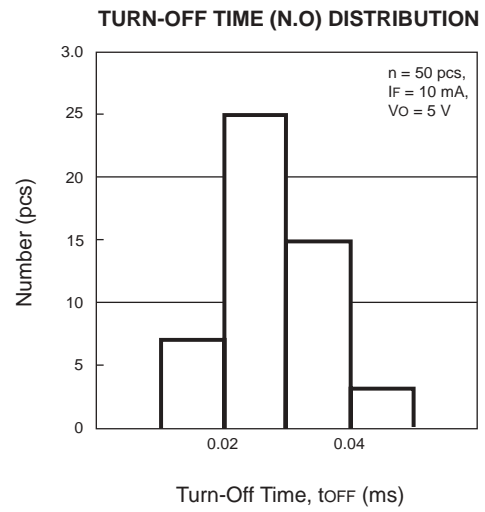
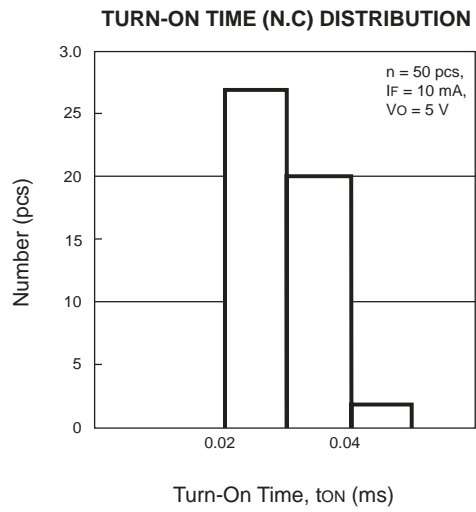
TYPICAL PERFORMANCE CURVES ($T_A = 25\text{ }^\circ\text{C}$)

PS7241-1C

TAPING SPECIFICATIONS (Units in mm)

OUTLINE AND DIMENSIONS (TAPE)

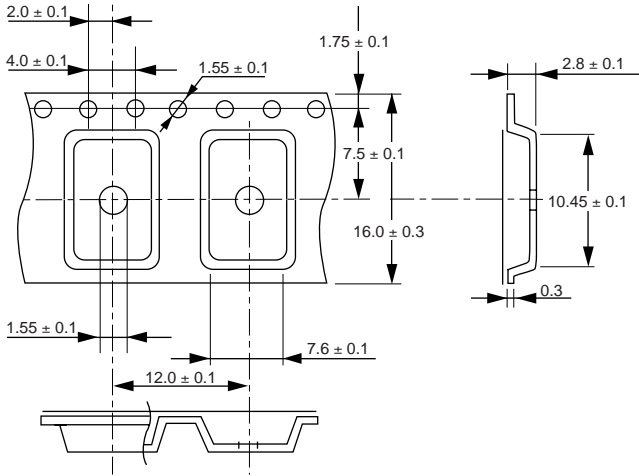

OUTLINE AND DIMENSIONS (REEL)

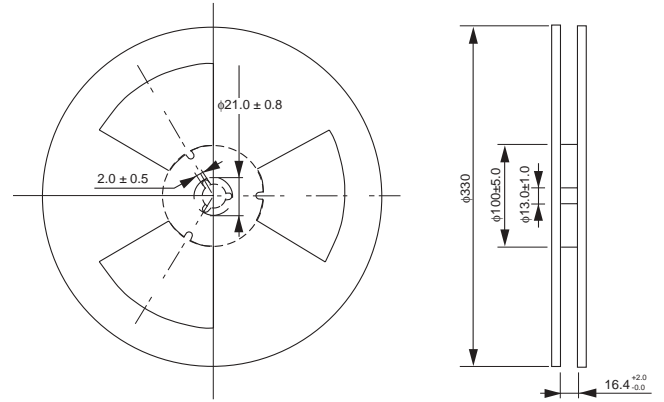

Packing : 1500 pcs/reel

TAPING DIRECTION

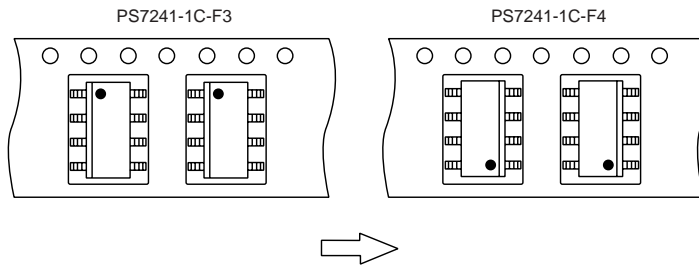

RECOMMENDED SOLDERING CONDITIONS

(1) Infrared reflow soldering

- Peak reflow temperature 235 °C or below (package surface temperature)
- Time of temperature higher than 210 °C 30 seconds or less
- Number of reflows Two
- Flux Rosin flux containing small amount of chlorine
(The flux with a maximum chlorine content of 0.2 Wt % is recommended.)

Recommended Temperature Profile of Infrared Reflow

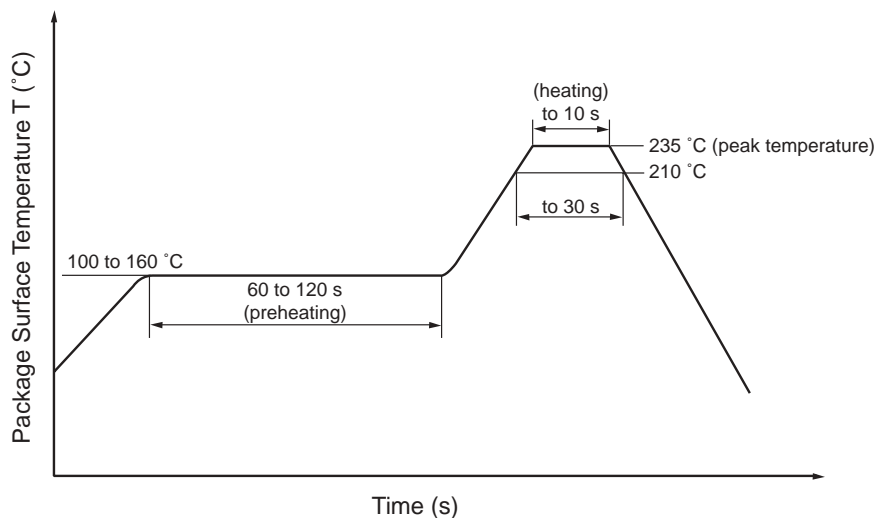

(2) Dip soldering

- Temperature 260 °C or below (molten solder temperature)
- Time 10 seconds or less
- Number of times One
- Flux Rosin flux containing small amount of chlorine
(The flux with a maximum chlorine content of 0.2 Wt % is recommended.)

(3) Cautions

- Fluxes
Avoid removing the residual flux with freon-based and chlorine-based cleaning solvent.
- Avoid shorting between portion of frame and leads.

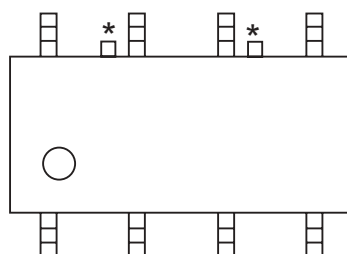

* : Portion of frame

EXCLUSIVE NORTH AMERICAN AGENT FOR **NEC** RF, MICROWAVE & OPTOELECTRONIC SEMICONDUCTORS

CEL CALIFORNIA EASTERN LABORATORIES • Headquarters • 4590 Patrick Henry Drive • Santa Clara, CA 95054-1817 • (408) 988-3500 • Telex 34-6393 • FAX (408) 988-0279
24-Hour Fax-On-Demand: 800-390-3232 (U.S. and Canada only) • Internet: <http://WWW.CEL.COM>

DATA SUBJECT TO CHANGE WITHOUT NOTICE

07/16/2001

Copyright © Each Manufacturing Company.

All Datasheets cannot be modified without permission.

This datasheet has been download from :

www.AllDataSheet.com

100% Free DataSheet Search Site.

Free Download.

No Register.

Fast Search System.

www.AllDataSheet.com