

# NEC

## HIGH CMR, 10 Mbps TOTEM POLE OUTPUT TYPE 5-PIN SOP PHOTOCOUPLER

### PS9715

### FEATURES

- **HIGH COMMON MODE TRANSIENT IMMUNITY**  
CMH, CML = ±20 kV/μs TYP
- **SMALL AND THIN PACKAGE**  
5-pin SOP
- **HIGH SPEED**  
10 Mbps
- **PULSE WIDTH DISTORTION**  
|tPHL - tPLH| = 7 ns TYP
- **HIGH ISOLATION VOLTAGE**  
BV = 2500 Vr.m.s.
- **TOTEM POLE OUTPUT**  
No pull-up resistor required
- **AVAILABLE IN TAPE AND REEL**  
PS9715-F3, F4: 3500 pcs/reel

### DESCRIPTION

PS9715 is an optically coupled high-speed, totem pole output isolator containing a GaAlAs LED on the light emitting side (input side) and a photodiode and a signal processing circuit on the light receiving side (output side) on one chip.

### APPLICATIONS

- LAN/FA
- MEASUREMENT EQUIPMENT
- PDP

PS9715

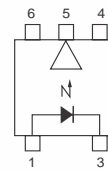

### ELECTRICAL CHARACTERISTICS (TA = 0 to +85°C, Unless otherwise specified)

		PART NUMBER			PS9715		
SYMBOL		PARAMETERS	UNITS	MIN	TYP <sup>1</sup>	MAX	
Diode	V <sub>F</sub>	Forward Voltage, I <sub>F</sub> = 10 mA, T <sub>A</sub> = 25°C	V	1.4	1.65	1.9	
	I <sub>R</sub>	Reverse Current, V <sub>R</sub> = 3 V, T <sub>A</sub> = 25°C	μA			10	
	C <sub>t</sub>	Capacitance, V = 0, f = 1 MHz, T <sub>A</sub> = 25°C	pF		30		
Detector	I <sub>OH</sub>	High Level Output Current <sup>2</sup> V <sub>CC</sub> = V <sub>O</sub> = 5.5 V, V <sub>F</sub> = 0.8 V	μA		0.003	200	
	V <sub>OH</sub>	High Level Output Voltage V <sub>CC</sub> = 4.5 V, I <sub>F</sub> = 250 μA, I <sub>OH</sub> = -2 mA	V	2.4	3.0		
	V <sub>OL</sub>	Low Level Output Voltage V <sub>CC</sub> = 4.5 V, V <sub>F</sub> = 0.8 V, I <sub>OL</sub> = 8 mA	V		0.25	0.6	
	I <sub>CCH</sub>	High Level Supply Current, V <sub>CC</sub> = 5.5 V, I <sub>F</sub> = 0 mA	mA		12	17	
	I <sub>CCL</sub>	Low Level Supply Current, V <sub>CC</sub> = 5.5 V, I <sub>F</sub> = 10 mA	mA		13	18	
	I <sub>OSH</sub>	High Level Output Short Circuit Current, V <sub>CC</sub> = 5.5 V, V <sub>O</sub> = GND I <sub>F</sub> = 0 mA, 10 ms or less	mA		-26		
	I <sub>OSL</sub>	Low Level Output Short Circuit Current, V <sub>CC</sub> = 5.5 V, V <sub>O</sub> = GND I <sub>F</sub> = 8 mA, 10 ms or less	mA		34		
Coupled	I <sub>FHL</sub>	Threshold Input Current, High → Low, V <sub>CC</sub> = 5 V	mA		2.3	5	
	R <sub>I-O</sub>	Isolation Resistance, V <sub>I-O</sub> = 1 k Vdc, R <sub>H</sub> = 40 to 60%, T <sub>A</sub> = 25°C	Ω	10 <sup>11</sup>			
	C <sub>I-O</sub>	Isolation Capacitance, V = 0, f = 1 MHz, T <sub>A</sub> = 25°C	pF		0.4		
	t <sub>PHL</sub>	Propagation Delay Time <sup>1</sup> , High → Low V <sub>CC</sub> = 5 V, I <sub>F</sub> = 7.5 mA	ns	15	33	65	
	t <sub>PLH</sub>	Propagation Delay Time <sup>1</sup> , Low → High V <sub>CC</sub> = 5 V, I <sub>F</sub> = 7.5 mA	ns	15	40	65	



## ELECTRICAL CHARACTERISTICS (TA = 0 to +85°C, Unless otherwise specified), Continued

		PART NUMBER	PS9715			
SYMBOL		PARAMETERS	UNITS	MIN	TYP	MAX
Coupled	tPHL - tPLH	Pulse Width Distortion, (PWD) <sup>3</sup> , VCC = 5 V, IF = 7.5 mA	ns		7	50
	CMH	Common Mode Transient Immunity at High Level Output <sup>4</sup> , VCC = 5 V, TA = 25°C, IF = 0 mA, VO (MIN) = 2 V, VCM = 1 kV	kV/μs	10	20	
	CML	Common Mode Transient Immunity at Low Level Output <sup>4</sup> , VCC = 5 V, TA = 25°C, IF = 7.5 mA, VO (MAX) = 0.8 V, VCM = 1 kV	kV/μs	10	20	

### Notes:

- Typical values at TA = 25°C.
- Because a high level output current (IOH) of 300 μA or more may be output when the temperature is 0°C or less and when VCC is around 3 to 4 V, it is important to confirm the characteristics (operation with the power supply on and off) during design, before using the device.
- Test Circuit for Propagation delay time

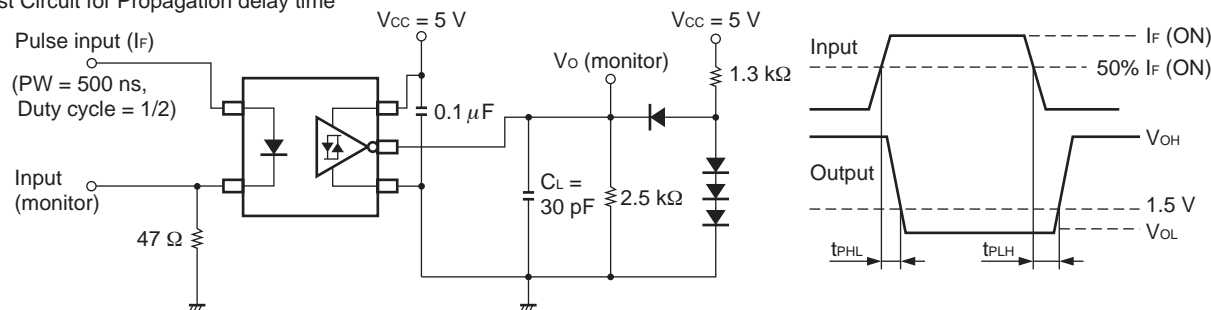

CL includes probe and stray wiring capacitance.

- Test Circuit for common mode transient immunity

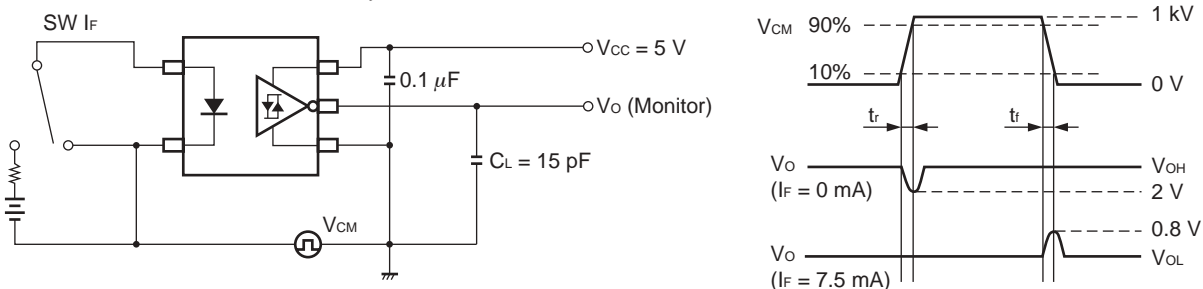

CL includes probe and stray wiring capacitance.

### USAGE CAUTIONS

- This device is ESD sensitive.
- Bypass capacitor of more than 0.1 μF is used between VCC and GND near device. Also, ensure that the distance between the leads of the photocoupler and capacitor is no more than 10 mm.

### ABSOLUTE MAXIMUM RATINGS<sup>1</sup> (TA = 25°C)

SYMBOLS	PARAMETERS	UNITS	RATINGS
Diode			
IF	Forward Current	mA	30
VR	Reverse Voltage	V	5
Detector			
VCC	Supply Voltage	V	7
VO	Output Voltage	V	7
IOH	High level Output Current <sup>2</sup>	mA	-5
IOL	Low level Output Current <sup>2</sup>	mA	13
PC	Power Dissipation <sup>2,3</sup>	mW	130
Coupled			
BV	Isolation Voltage <sup>4</sup>	V <sub>r.m.s.</sub>	2500
TOP	Operating Temperature	°C	-40 to +85
TSTG	Storage Temperature	°C	-55 to +125

### Notes:

- Operation in excess of any one of these parameters may result in permanent damage.
- TA = -40 to +85°C, Applies to output pin VO and power supply pin

### RECOMMENDED OPERATING CONDITIONS

PART NUMBER			PS9715		
SYMBOLS	PARAMETERS	UNITS	MIN	TYP	MAX
IFH	High Level Input Current	mA	7.5		12.5
IFL	Low Level Input Current	μA	0		250
VCC	Supply Voltage	V	4.5	5.0	5.5
N	TTL(loads)				3
TA	Operating Temperature	°C	0		+85

- AC voltage for 1 minute at TA = 25 °C, RH = 60% between input and output.

**TYPICAL PERFORMANCE CURVES** (TA = 25°C)

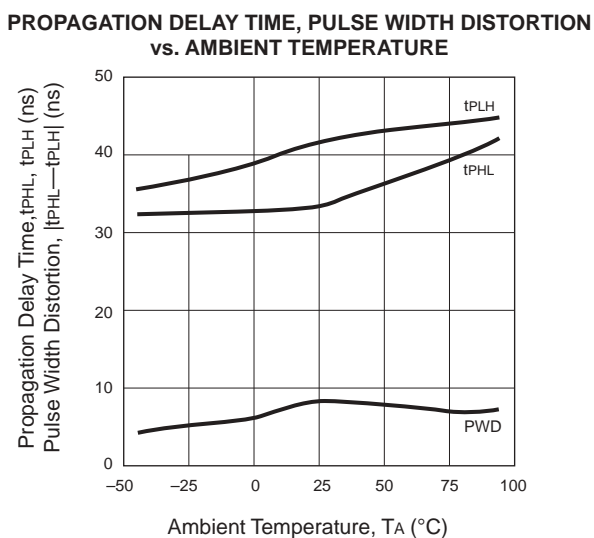
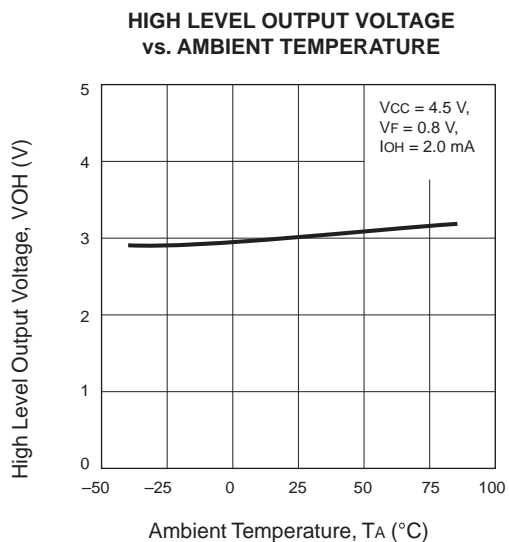
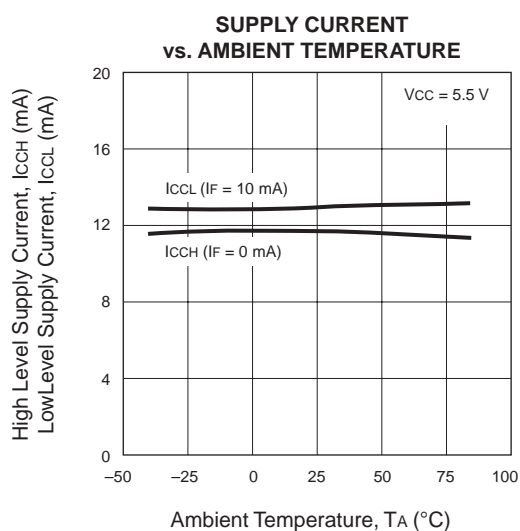
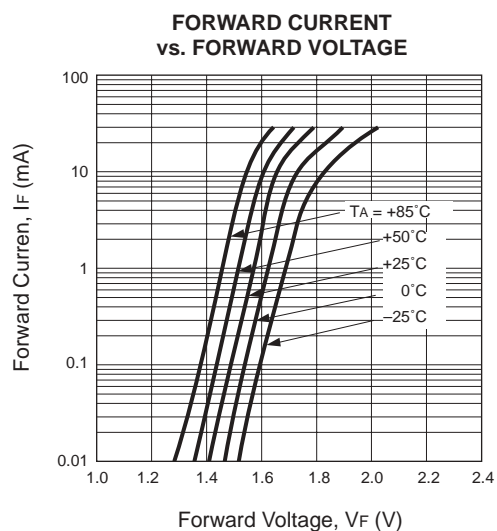
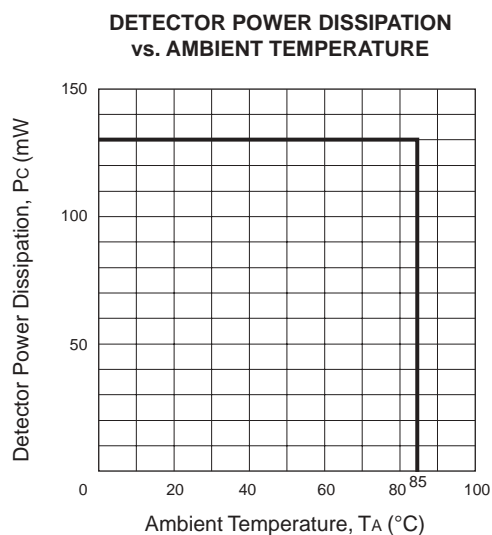
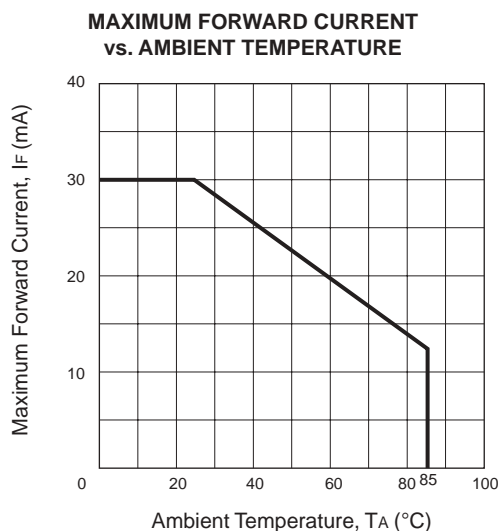

**TYPICAL PERFORMANCE CURVES** (TA = 25°C)

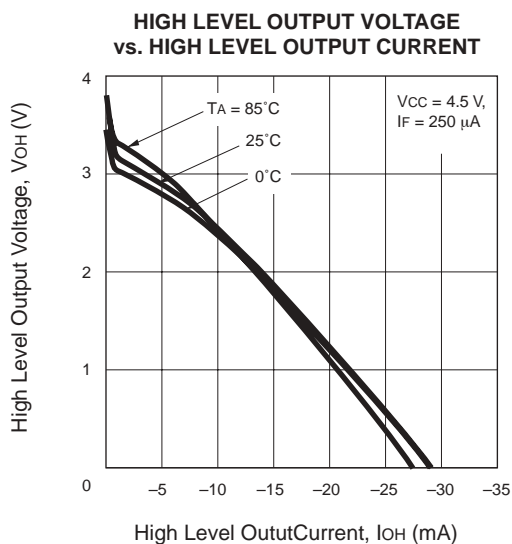
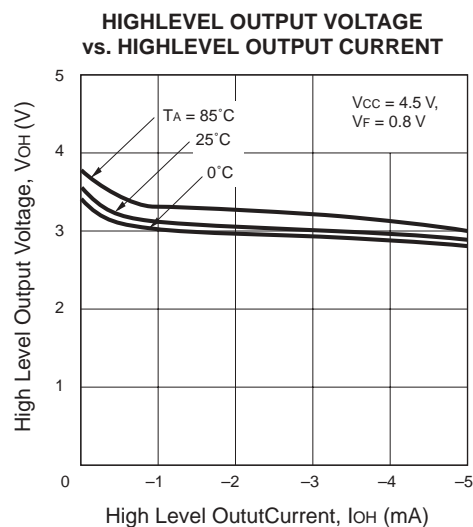
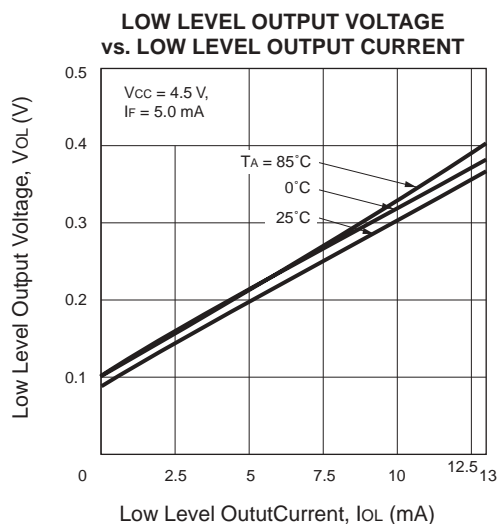
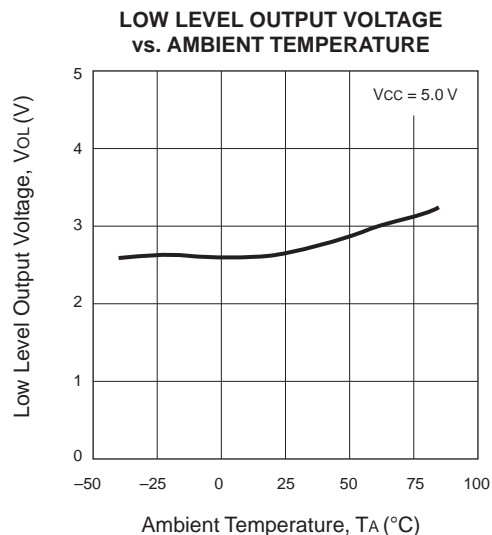
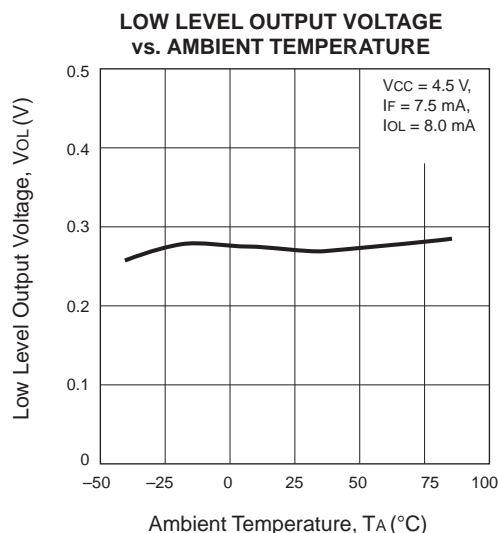

**PROPAGATION DELAY TIME, PULSE WIDTH DISTORTION vs. FORWARD CURRENT**

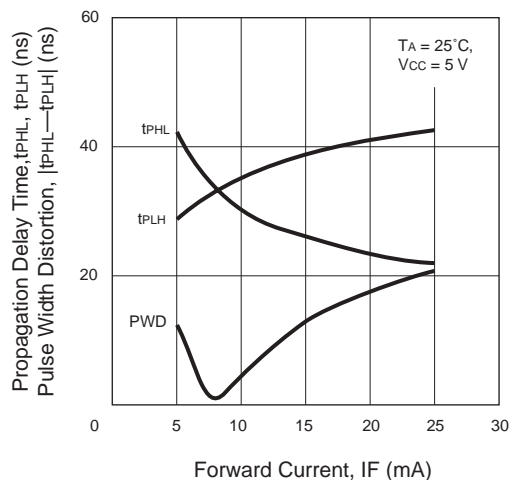

# PS9715

## OUTLINE DIMENSIONS (Units in mm)

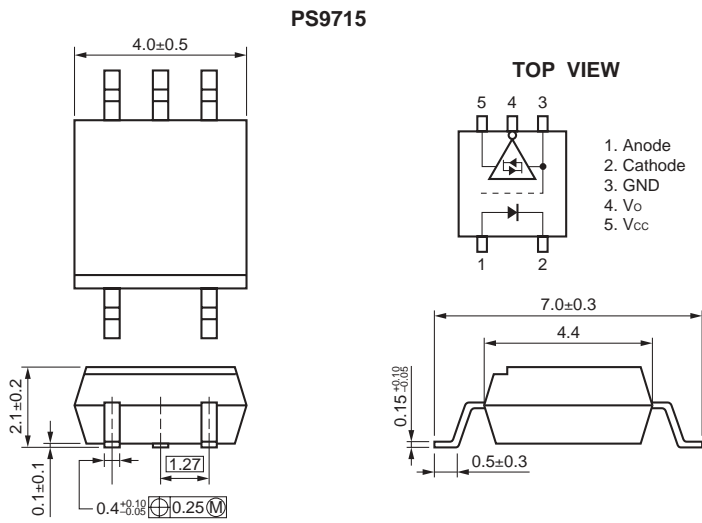

## MARKING

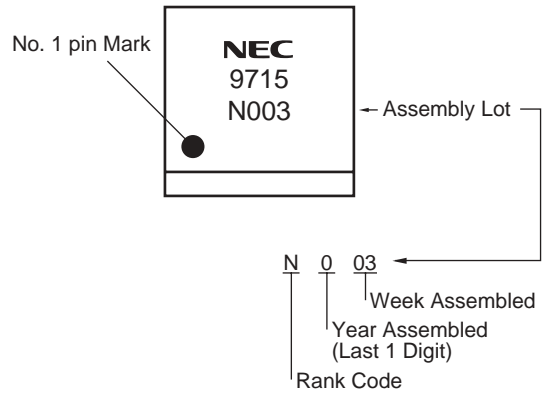

## TAPING SPECIFICATIONS (Units in mm)

### TAPE OUTLINE AND DIMENSIONS

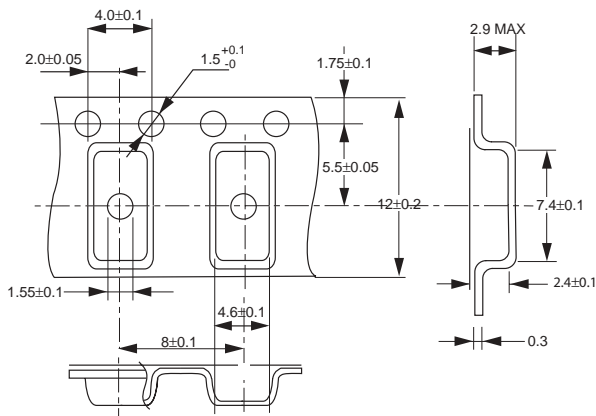

### REEL OUTLINE AND DIMENSIONS

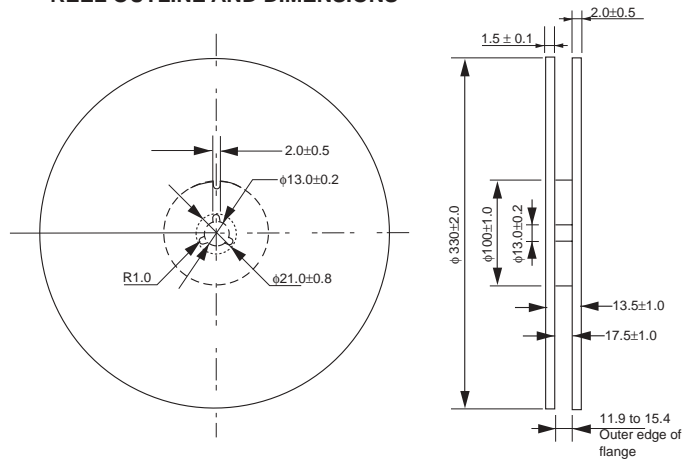

Packing : 3500 pcs/reel

### TAPE DIRECTION

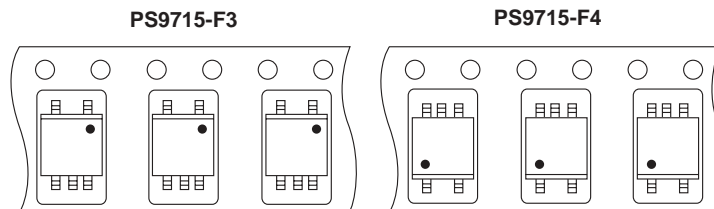

**RECOMMENDED SOLDERING CONDITIONS**

**(1) Infrared reflow soldering**

- Peak reflow temperature 235°C or below (package surface temperature)
- Time of temperature higher than 210 °C 30 seconds or less
- Number of reflows Three
- Flux Rosin flux containing small amount of chlorine (The flux with a maximum chlorine content of 0.2 Wt % is recommended.)

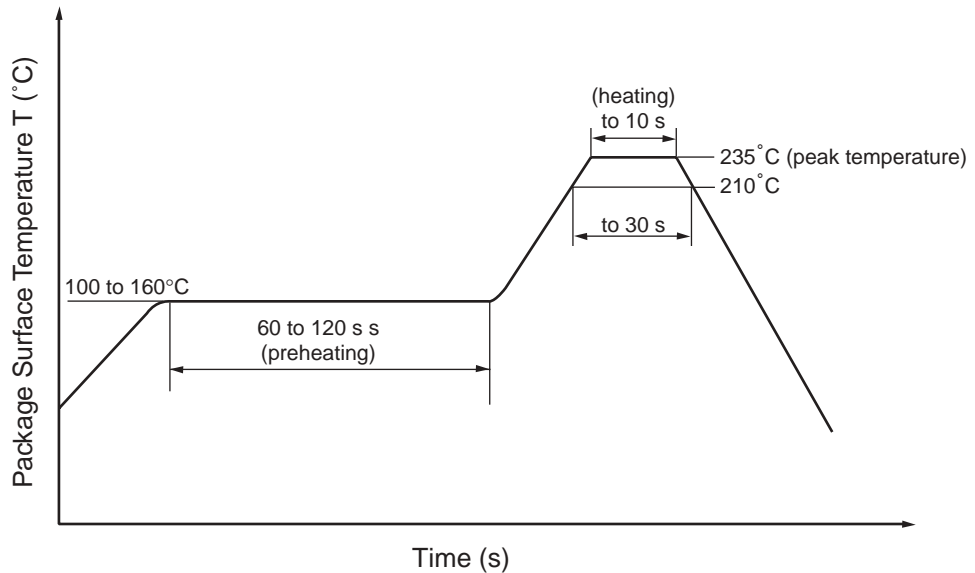

**(3) Cautions**

- Fluxes  
Avoid removing the residual flux with freon-based and chlorine-based cleaning solvent.

Life Support Applications

These NEC products are not intended for use in life support devices, appliances, or systems where the malfunction of these products can reasonably be expected to result in personal injury. The customers of CEL using or selling these products for use in such applications do so at their own risk and agree to fully indemnify CEL for all damages resulting from such improper use or sale.