

# System Reset Monolithic IC PST993, 994

## Outline

The function of this IC is to accurately reset systems after detecting the supply voltage at the time of switching power on and instantaneous power off in various CPU and other logic systems. Further, this IC can be offered at low cost because it is designed to be simplified allowing for the replacement from reset circuit of discrete configuration.

## Features

- |   |   |                 |          |          |          |          |          |          |          |          |          |
|---|---|-----------------|----------|----------|----------|----------|----------|----------|----------|----------|----------|
| 1. Voltage detect precision                         | $V_S \pm 5\%$ max.  |                 |          |          |          |          |          |          |          |          |          |
| 2. Low consumption current                          | $I_{CCH} = 300\mu A$ typ. $I_{CCL} = 250\mu A$ typ.   |                 |          |          |          |          |          |          |          |          |          |
| 3. Low operating threshold voltage                  | 0.65V typ.  |                 |          |          |          |          |          |          |          |          |          |
| 4. Hysteresis voltage is provided as detect voltage | 50mV typ.   |                 |          |          |          |          |          |          |          |          |          |
| 5. Large output current at the time ON              | 15mA typ.   |                 |          |          |          |          |          |          |          |          |          |
| 6. Detect voltage rank                              | <table border="0"> <tr> <td>PST993 C : 4.5V</td> <td>H : 3.1V</td> </tr> <tr> <td>D : 4.2V</td> <td>I : 2.9V</td> </tr> <tr> <td>E : 3.9V</td> <td>J : 2.7V</td> </tr> <tr> <td>F : 3.6V</td> <td>K : 2.5V</td> </tr> <tr> <td>G : 3.3V</td> <td>L : 2.3V</td> </tr> </table> (Same ranks for PST994 too) | PST993 C : 4.5V | H : 3.1V | D : 4.2V | I : 2.9V | E : 3.9V | J : 2.7V | F : 3.6V | K : 2.5V | G : 3.3V | L : 2.3V |
| PST993 C : 4.5V                                     | H : 3.1V  |                 |          |          |          |          |          |          |          |          |          |
| D : 4.2V  | I : 2.9V  |                 |          |          |          |          |          |          |          |          |          |
| E : 3.9V  | J : 2.7V  |                 |          |          |          |          |          |          |          |          |          |
| F : 3.6V  | K : 2.5V  |                 |          |          |          |          |          |          |          |          |          |
| G : 3.3V  | L : 2.3V  |                 |          |          |          |          |          |          |          |          |          |
| 7. Output form                                      |   |                 |          |          |          |          |          |          |          |          |          |
| PST993 : Constant current load built-in             |   |                 |          |          |          |          |          |          |          |          |          |
| PST994 : Open collector                             |   |                 |          |          |          |          |          |          |          |          |          |

## Packages

TO-92A (PST993□, PST994□)  
 \*□ contains detection voltage rank.

## Applications

1. Reset circuits for microcomputers, CPU and MPU.
2. Reset circuit for logic circuitry.
3. Level detecting circuit.

## Pin Assignment

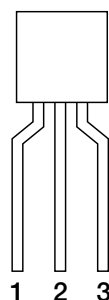

1	V <sub>CC</sub>
2	GND
3	V <sub>OUT</sub>

TO-92A

## Equivalent Circuit Diagram

■ PST993

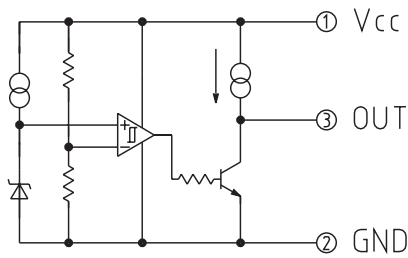

■ PST994

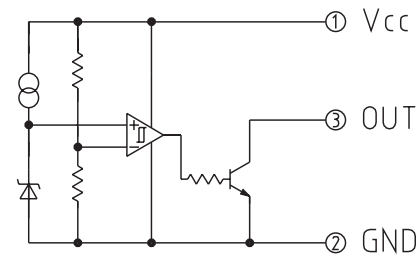

## Absolute Maximum Ratings (Ta=25°C)

Item	Symbol	Ratings	Units
Storage temperature	T <sub>STG</sub>	-40~+125	°C
Operating temperature	T <sub>OPR</sub>	-20~+75	°C
Supply voltage	V <sub>CC</sub>	-0.3~10	V
Allowable loss	P <sub>d</sub>	300	mW

## Electrical Characteristics (Ta=25°C) (The unit of resistance is Ω unless otherwise indicated.)

Item	Symbol	Measurement Circuit	Measurement conditions	Min.	Typ.	Max.	Units	
Detection Voltage	V <sub>s</sub>	1	R <sub>L</sub> =∞ V <sub>CC</sub> =H→L	PST993C	4.27	4.5	4.73	V
				PST993D	4.00	4.2	4.40	
				PST993E	3.70	3.9	4.10	
				PST993F	3.42	3.6	3.78	
				PST993G	3.13	3.3	3.47	
				PST993H	2.94	3.1	3.26	
				PST993I	2.75	2.9	3.05	
				PST993J	2.56	2.7	2.84	
				PST993K	2.37	2.5	2.63	
				PST993L	2.18	2.3	2.42	
Hysteresis Voltage	ΔV <sub>s</sub>	1	R <sub>L</sub> =∞, V <sub>CC</sub> =L→H→L	30	50	100	mV	
Detection Voltage Temperature Coefficient	V <sub>s</sub> /ΔT	1	R <sub>L</sub> =∞, Ta=-20~+75°C		±0.01		%/°C	
Low Level Output Voltage	V <sub>OL</sub>	1	V <sub>CC</sub> =V <sub>s</sub> min. -0.05V, R <sub>L</sub> =1k		0.1	0.4	V	
Output Constant Current	I <sub>oC</sub>	1	V <sub>O</sub> =2.5V, V <sub>CC</sub> =5V, R <sub>L</sub> =∞	-40	-25	-17	μA	
Circuit Current at ON Time	I <sub>cCL</sub>	1	V <sub>CC</sub> =V <sub>s</sub> min. -0.05V, R <sub>L</sub> =∞		250	400	μA	
Circuit Current at OFF Time	I <sub>cCH</sub>	1	V <sub>CC</sub> =V <sub>s</sub> typ. /0.85V, R <sub>L</sub> =∞		300	500	μA	
"H" Transmission Delay Time	tpLH	2	C <sub>L</sub> =100pF		20		μS	
"L" Transmission Delay Time	tpHL	2	C <sub>L</sub> =100pF		1		μS	
Operating Threshold Voltage	V <sub>oPL</sub>	1	R <sub>L</sub> =4.7k, V <sub>OL</sub> ≤ 0.4V		0.65	0.85	V	
Output Current at ON Time 1	I <sub>oL1</sub>	1	R <sub>L</sub> =∞, V <sub>O</sub> =0.4V V <sub>CC</sub> =V <sub>s</sub> min. -0.05V	6	15		mA	
Output Current at ON Time 2	I <sub>oL2</sub>	1	Ta=-20~+75°C, R <sub>L</sub> =∞ V <sub>O</sub> =0.4V, V <sub>CC</sub> =V <sub>s</sub> min. -0.05V	4			mA	

\*Do not apply onto the OUT terminal any voltage higher than that at the V<sub>CC</sub> terminal.

(\*1) The tpLH is a function of the charging time of C<sub>L</sub> by output constant current.

The delay time of this IC is about 1 μS.

**Absolute Maximum Ratings** (Ta=25°C)

Item	Symbol	Ratings	Units
Storage temperature	T <sub>STG</sub>	-40~+125	°C
Operating temperature	T <sub>OPR</sub>	-20~+75	°C
Supply voltage	V <sub>CC</sub>	-0.3~10	V
Allowable loss	P <sub>d</sub>	300	mW

**Electrical Characteristics** (Ta=25°C) (The unit of resistance is Ω unless otherwise indicated.)

Item	Symbol	Measurement Circuit	Measurement conditions	Min.	Typ.	Max.	Units	
Detection Voltage	V <sub>s</sub>	1	R <sub>L</sub> =1k V <sub>CC</sub> =H→L	PST994C	4.27	4.5	4.73	V
				PST994D	4.00	4.2	4.40	
				PST994E	3.70	3.9	4.10	
				PST994F	3.42	3.6	3.78	
				PST994G	3.13	3.3	3.47	
				PST994H	2.94	3.1	3.26	
				PST994I	2.75	2.9	3.05	
				PST994J	2.56	2.7	2.84	
				PST994K	2.37	2.5	2.63	
PST994L	2.18	2.3	2.42					
Hysteresis Voltage	ΔV <sub>s</sub>	1	R <sub>L</sub> =1k, V <sub>CC</sub> =L→H→L	30	50	100	mV	
Detection Voltage Temperature Coefficient	V <sub>s</sub> /ΔT	1	R <sub>L</sub> =1k, Ta=-20~+75°C		±0.01		%/°C	
Low Level Output Voltage	V <sub>OL</sub>	1	V <sub>CC</sub> =V <sub>s</sub> min. -0.05V, R <sub>L</sub> =1k		0.1	0.4	V	
Output Leakage Current	I <sub>OH</sub>	1	V <sub>CC</sub> =10V			0.1	μA	
Circuit Current at ON Time	I <sub>CCL</sub>	1	V <sub>CC</sub> =V <sub>s</sub> min. -0.05V, R <sub>L</sub> =∞		250	400	μA	
Circuit Current at OFF Time	I <sub>CCH</sub>	1	V <sub>CC</sub> =V <sub>s</sub> typ./0.85V, R <sub>L</sub> =∞		300	500	μA	
"H" Transmission Delay Time	tp <sub>LH</sub>	2	C <sub>L</sub> =100pF, R <sub>L</sub> =4.7k		1		μS	
"L" Transmission Delay Time	tp <sub>HL</sub>	2	C <sub>L</sub> =100pF, R <sub>L</sub> =4.7k		1		μS	
Operating Threshold Voltage	V <sub>OPL</sub>	1	R <sub>L</sub> =4.7k, V <sub>OL</sub> ≤ 0.4V		0.65	0.85	V	
Output Current at ON Time 1	I <sub>OL1</sub>	1	V <sub>O</sub> =0.4V V <sub>CC</sub> =V <sub>s</sub> min. -0.05V	6	15		mA	
Output Current at ON Time 2	I <sub>OL2</sub>	1	Ta=-20~+75°C V <sub>O</sub> =0.4V, V <sub>CC</sub> =V <sub>s</sub> min. -0.05V	4			mA	

\*Do not apply onto the OUT terminal any voltage higher than that at the V<sub>CC</sub> terminal.

(\*1) The tp<sub>LH</sub> is a function of the charging time of C<sub>L</sub> by output constant current.

The delay time of this IC is about 1 μS.

## Equivalent Circuit Diagram

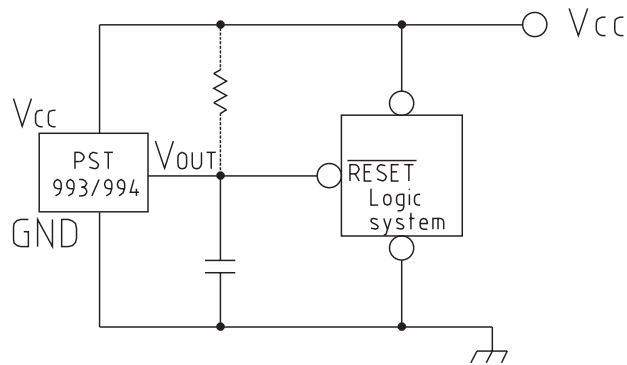

\* Since PST993 incorporates a constant current load, the pull-up resistance is not necessary.

## Characteristics

■ Vs vs. Ta

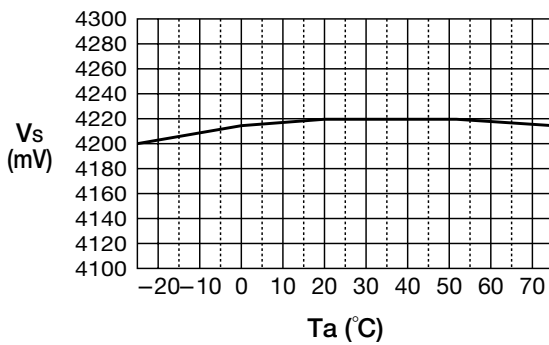

■ VopL vs. Ta

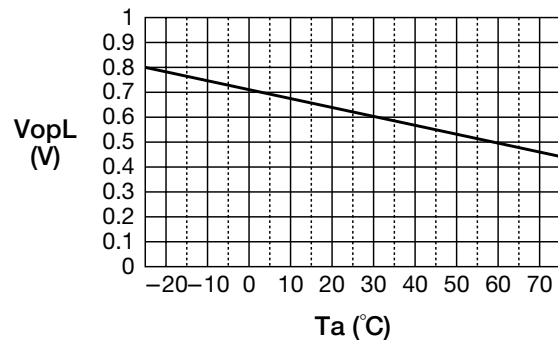

■ ΔVs vs. Ta

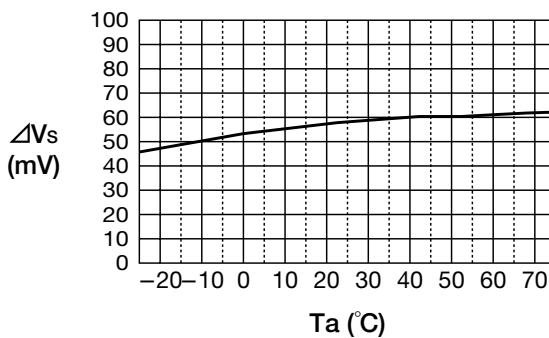

■ VoL vs. Ta

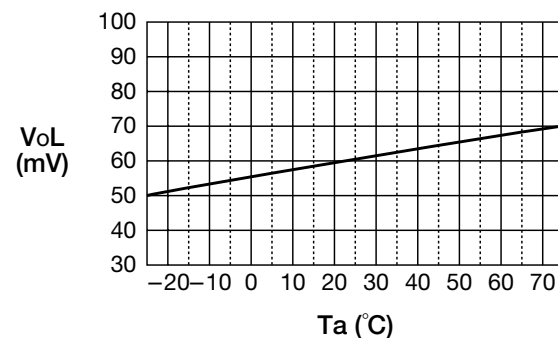

■ IccH vs. Ta

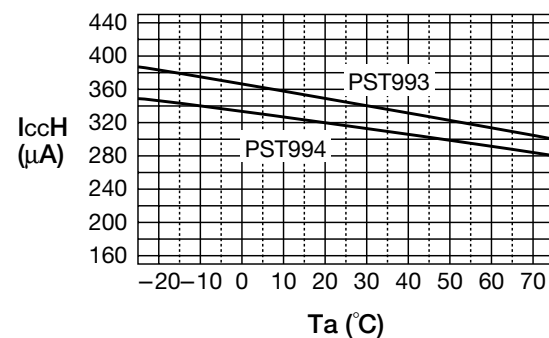

■ IoC vs. Ta (PST993)

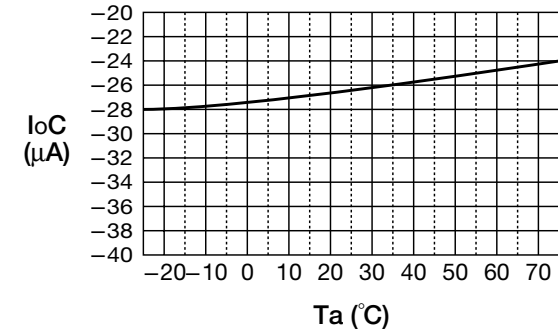

Copyright © Each Manufacturing Company.

All Datasheets cannot be modified without permission.

This datasheet has been download from :

[www.AllDataSheet.com](http://www.AllDataSheet.com)

100% Free DataSheet Search Site.

Free Download.

No Register.

Fast Search System.

[www.AllDataSheet.com](http://www.AllDataSheet.com)