



### Features

- 10W Output Power
- Input Voltage: 18V to 36V
- Output Voltages: 1.2V to 13.2V
- 1500 VDC Isolation
- Temp Range: -40°C to +85°C
- Remote On/Off Control
- Undervoltage Lockout
- Output Current Limit
- Short-Circuit Protection
- Low-Profile Package (8mm)
- Space Saving Package
- Solderable Copper Case
- Safety Agency Approvals:  
UL 60950  
CSA 22.2 60950

### Description

The PT4240 power modules are a series of DC/DC converters housed in an ultra-low profile (8mm) solderable copper case. The series includes a number of preset output voltages ranging from 1.3V<sup>†</sup> up to 12V, all fully approved for Telecom use. They may also be used in many other applications that require input-output isolation over an extended temperature range. The modules are an ideal choice for low-power digital and analog circuits, including DSPs and microcontrollers. The flexibility of input-output isolation also allows the output to be configured for negative voltage operation.

The PT4240 series is made available in both horizontal and vertical pin configurations, including surface mount.

### Ordering Information

PT4241	□ = 1.8V/3A	(5.4W)
PT4242	□ = 3.3V/3A	
PT4243	□ = 5.0V/2A	
PT4244	□ = 12.0V/0.85A	
PT4245	□ = 2.5V/3A	(7.5W)
PT4246	□ = 1.5V/3A	(4.5W)
† PT4247	□ = 1.3V/3A	(3.9W)

† Adjustable to 1.2V

### PT Series Suffix (PT1234 x)

Case/Pin Configuration	Order Suffix	Package Code
Vertical	<b>N</b>	(EPE)
Horizontal	<b>A</b>	(EPF)
SMD	<b>C</b>	(EPG)

(Reference the applicable package code drawing for the dimensions and PC board layout)

### Pin-Out Information

Pin	Function
1	Remote On/Off *
2	Do not connect
3	-V <sub>in</sub>
4	Do not connect
5	+V <sub>in</sub>
6	-V <sub>out</sub>
7	-V <sub>out</sub>
8	+V <sub>out</sub>
9	+V <sub>out</sub>
10	V <sub>out</sub> Adj *

\* For further information, see application notes.

### Standard Application

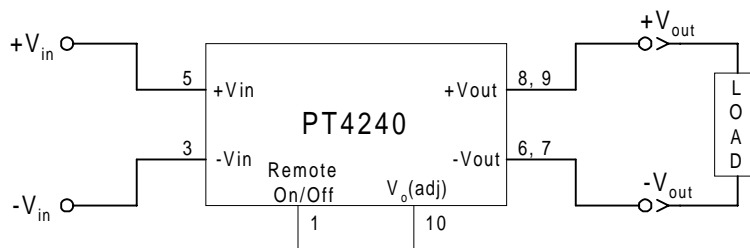

# PT4240 Series

## 10-W Low-Profile 24V-Input Isolated DC/DC Converter

### Specifications (Unless otherwise stated, $T_a = 25^\circ\text{C}$ , $V_{in} = 24\text{V}$ , $C_{in} = 0\mu\text{F}$ , $C_{out} = 0\mu\text{F}$ , and $I_o = I_{o,max}$ )

Characteristic	Symbol	Conditions	PT4240 SERIES			Units	
			Min	Typ	Max		
Output Current	$I_o$	Over $V_{in}$ range	$V_o \leq 3.3\text{V}$ $V_o = 5.0\text{V}$ $V_o = 12\text{V}$	0.1 (1) 0.1 (1) 0.1 (1)	— — —	3 2 0.85	
Input Voltage Range	$V_{in}$	Over $I_o$ Range		18.0	24.0	36.0	VDC
Set Point Voltage Tolerance	$V_o \text{ tol}$			—	$\pm 1$	$\pm 2$	$\%V_o$
Temperature Variation	$\text{Reg}_{\text{temp}}$	$-40^\circ \leq T_a \leq +85^\circ\text{C}$ , $I_o = I_{o,min}$		—	$\pm 0.2$	—	$\%V_o$
Line Regulation	$\text{Reg}_{\text{line}}$	Over $V_{in}$ range		—	$\pm 1$	—	mV
Load Regulation	$\text{Reg}_{\text{load}}$	Over $I_o$ range		—	$\pm 5$	—	mV
Total Output Voltage Variation	$\Delta V_o \text{ tot}$	Includes set-point, line, load, $-40^\circ \leq T_a \leq +85^\circ\text{C}$		—	$\pm 1.5$	$\pm 3$	$\%V_o$
Efficiency	$\eta$		$V_o = 12\text{V}$ $V_o = 5.0\text{V}$ $V_o = 3.3\text{V}$ $V_o = 2.5\text{V}$ $V_o = 1.8\text{V}$ $V_o = 1.5\text{V}$ $V_o = 1.3\text{V}$	— — — — — — —	86 84 80 77 72 70 64	— — — — — — —	%
$V_o$ Ripple (pk-pk)	$V_r$	20MHz bandwidth	$V_o \leq 5.0\text{V}$ $V_o = 12\text{V}$	— —	50 100	— —	mV <sub>pp</sub>
Transient Response	$t_{tr}$	1A/ $\mu\text{s}$ load step, 50% to 100% $I_{o,max}$		—	75	—	$\mu\text{s}$
	$\Delta V_{tr}$	$V_o$ over/undershoot	$V_o \leq 5.0\text{V}$ $V_o = 12\text{V}$	— —	$\pm 150$ $\pm 350$	— —	mV
Output Voltage Adjust	$V_{adj}$		$V_o \geq 2.5\text{V}$	$\pm 10$	—	—	$\%V_o$
Current Limit Threshold	$I_{lim}$	$V_{in} = 18\text{V}$ , $\Delta V_o = -1\%$		—	150	—	$\%I_{o,max}$
Switching Frequency	$f_s$	Over $V_{in}$ range		250	300	350	kHz
Under-Voltage Lockout	UVLO			—	16	—	V
Remote On/Off (Pin 1)		Referenced to $-V_{in}$ (pin 3)					
Input High Voltage	$V_{IH}$			4.5	—	Open (3)	V
Input Low Voltage	$V_{IL}$			-0.2	—	+0.8	
Input Low Current	$I_{IL}$			—	-0.5	—	mA
Standby Input Current	$I_{in, standby}$	pins 1 & 3 connected		—	1	—	mA
Internal Input Capacitance	$C_{in}$			—	0.66	—	$\mu\text{F}$
External Output Capacitance	$C_{out}$		$V_o \leq 5.0\text{V}$ $V_o = 12\text{V}$	0 (5) 0 (5)	— —	1000 330	$\mu\text{F}$
Isolation Voltage		Input-output/input-case		1500	—	—	V
Capacitance		Input to output		—	1,100	—	pF
Resistance		Input to output		10	—	—	M $\Omega$
Operating Temperature Range	$T_a$	Over $V_{in}$ range		-40	—	+85 (4)	$^\circ\text{C}$
Storage Temperature	$T_s$	—		-40	—	+125	$^\circ\text{C}$
Reliability	MTBF	Per Bellcore TR-332 50% stress, $T_a = 40^\circ\text{C}$ , ground benign		4.7	—	—	$10^6$ Hrs
Mechanical Shock	—	Per Mil-Std-883D, method 2002.3, 1mS, half-sine, mounted to a fixture		—	500	—	G's
Mechanical Vibration	—	Mil-Std-883D, Method 2007.2 20-2000Hz, all case styles soldered to PC		—	20 (6)	—	G's
Weight	—	—		—	20	—	grams
Flammability	—	Materials meet UL 94V-0		—	—	—	

- Notes:**
- (1) The DC/DC converter will operate at no load with reduced specifications.
  - (2) The maximum output current reduces the output power of the following devices to less than 10W:-  
PT4245 = 7.5W; PT4241 = 5.4W; PT4246 = 4.5W; PT4247 = 3.9W.
  - (3) The Remote On/Off (pin 1) has an internal pull-up, and if it is left open circuit the converter will operate when input power is applied. The open-circuit voltage is typically 5V. Refer to the application notes for interface considerations.
  - (4) See Safe Operating Area curves or contact the factory for the appropriate derating.
  - (5) An output capacitor is not required for proper operation.
  - (6) The case pins on through-hole pin configurations (N & A) must be soldered. For more information see the applicable package outline drawing.

# PT4240 Series

10-W Low-Profile 24V-Input Isolated DC/DC Converter

**PT4242,  $V_o = 3.3\text{VDC}$**  (See Note A)

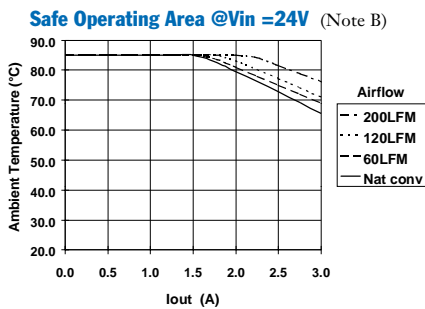
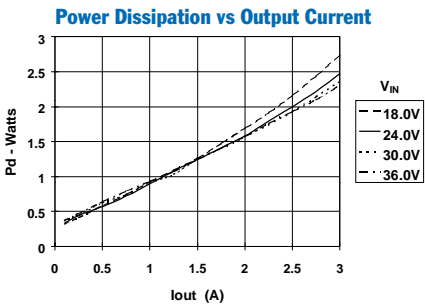
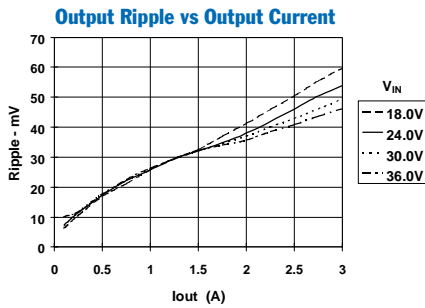
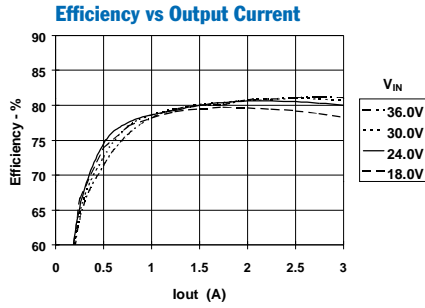

**PT4243,  $V_o = 5.0\text{VDC}$**  (See Note A)

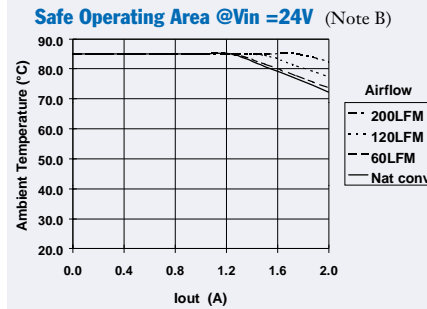
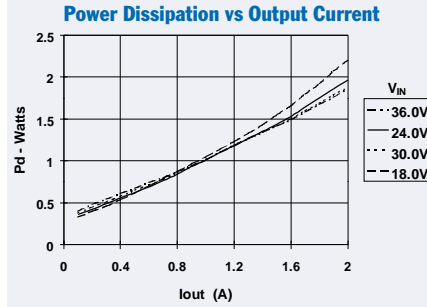
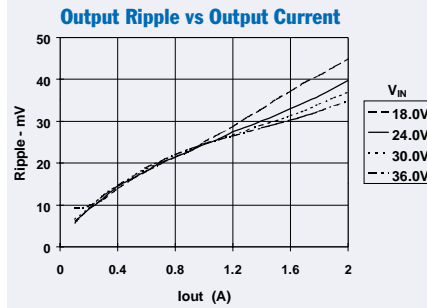
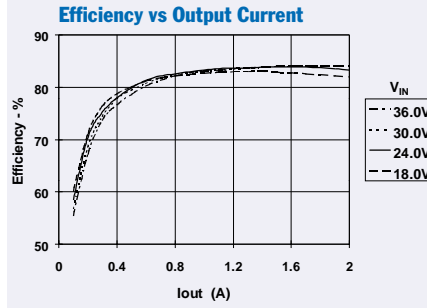

**PT4244,  $V_o = 12.0\text{VDC}$**  (See Note A)

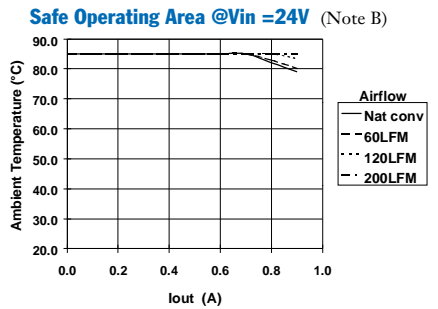
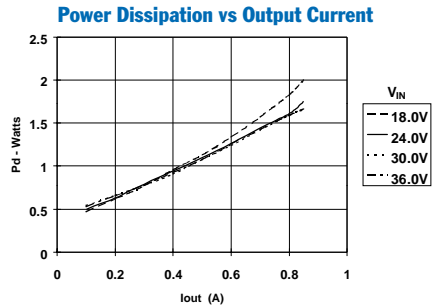
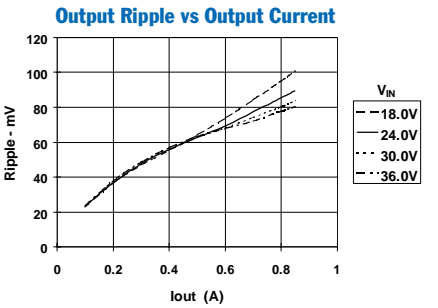
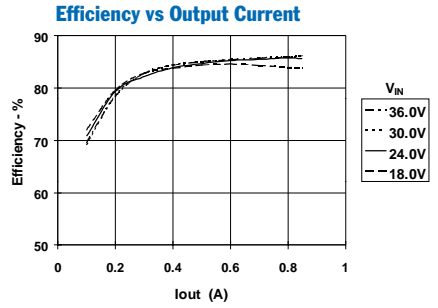

**Note A:** All Characteristic data in the above graphs has been developed from actual products tested at 25°C. This data is considered typical data for the converter.  
**Note B:** SOA curves represent operating conditions at which internal components are at or below manufacturer's maximum rated operating temperatures.

### Using the Remote On/Off with the PT4220/4240 Isolated 10W Excalibur™ DC/DC Converters

For applications requiring output voltage On/Off control, the PT4220/4240 DC/DC converter series incorporates a “Remote On/Off” control (pin 1). This feature can be used to switch the module off without removing the applied input source voltage.

The converter functions normally with Pin 1 open-circuit, providing a regulated output voltage when a valid source voltage is applied to  $+V_{in}$  (pin 5), with respect to  $-V_{in}$  (pin 3). When a low-level<sup>1</sup> ground signal is applied to pin 1, the converter output will be turned off.

Figure 1 shows an application schematic, which details the typical use of the *Remote On/Off* function. Note the discrete transistor (Q1). The pin has its own internal pull-up, allowing it to be controlled with an open-collector or open-drain device (See notes 2 & 3). Table 1 gives the threshold requirements.

When placed in the “Off” state, the standby current drawn from the input source is typically reduced to less than 1mA.

**Table 1; Pin 1 Remote On/Off Control Parameters<sup>1</sup>**

Parameter	Min	Typ	Max
Enable ( $V_{IH}$ )	4.5V	—	—
Disable ( $V_{IL}$ )	—	—	0.8V
$V_{O/c}$ [Open-Circuit]	—	5.0V	—
$I_{in}$ [pin 1 at $-V_{in}$ ]	—	—	-0.5mA

#### Notes:

1. The *Remote On/Off* control uses  $-V_{in}$  (pin 3) as its ground reference. All voltages specified are with respect to  $-V_{in}$ .
2. Use an open-collector device (preferably a discrete transistor) for the *Remote On/Off* input. A pull-up resistor is not necessary. To disable the output voltage, the control pin should be pulled low to less than +0.8VDC.
3. The *Remote On/Off* pin may be controlled with devices that have a totem-pole output. This is provided the drive voltage meets the threshold requirements in Table 1. Do not apply more than +20V. If a TTL gate is used, a pull-up resistor may be required to the logic supply voltage.
4. The PT4220/4240 converters incorporate an “Under-Voltage Lockout” (UVLO). The UVLO will keep the module off when the input voltage to the converter is low, regardless of the state of the *Remote On/Off* control. Table 2 gives the UVLO input voltage thresholds.

**Table 2; UVLO Thresholds<sup>4</sup>**

Series	$V_{in}$ Range	UVLO Threshold
PT4220	36 – 75V	32V $\pm$ 2V
PT4240	18 – 36V	15.8V $\pm$ 2V

**Figure 1**

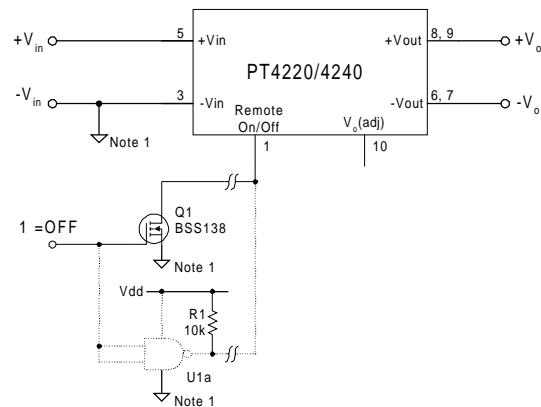

**Turn-On Time:** In the circuit of Figure 1, turning Q1 on applies a low-voltage to pin 1 and disables the converter output. Correspondingly, turning Q1 off allows pin 1 to be pulled high by an internal pull-up resistor. The converter produces a regulated output voltage within 60ms. Figure 2 shows the output response of a PT4223 (5.0V) following the turn-off of Q1. The turn off of Q1 corresponds to the drop in Q1 Vgs. Although the rise-time of the output voltage is short (<5ms), the indicated delay time will vary depending upon the input voltage and the module’s internal timing. The waveform was measured with a 48Vdc input voltage, and a 1.4A resistive load.

**Figure 2**

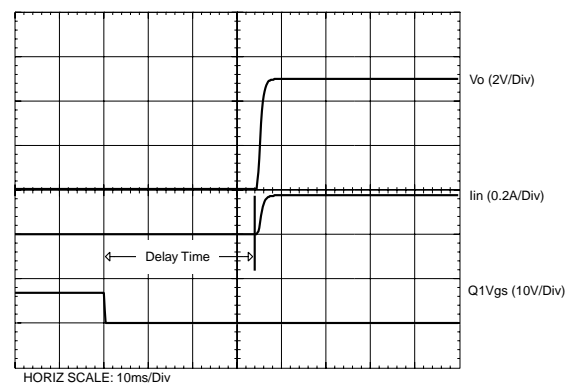

## Adjusting the Output Voltage of the 10W-Rated Excalibur™ Series of Isolated DC/DC Converters

The factory pre-set output voltage of Power Trends' 10W Excalibur series of isolated DC-DC converters may be adjusted over a narrow range. This is accomplished with the addition of a single external resistor. For the input voltage range specified in the data sheet, Table 1 gives the allowable adjustment range for each model as  $V_o$  (min) and  $V_o$  (max).

**Adjust Up:** An increase in the output voltage is obtained by adding a resistor,  $R_2$  between pin 10 ( $V_o$  adjust), and pins 6 & 7 ( $-V_{out}$ ).

**Adjust Down:** Add a resistor ( $R_1$ ), between pin 10 ( $V_o$  adjust) and pins 8 & 9 ( $+V_{out}$ ).

Refer to Figure 1 and Table 2 for both the placement and value of the required resistor, ( $R_1$ ) or  $R_2$ .

The values of ( $R_1$ ) [adjust down], and  $R_2$  [adjust up], can also be calculated using the following formulas.

$$(R_1) = \frac{56.2 (V_a - 1.225)}{V_o - V_a} - R_s \quad \text{k}\Omega$$

$$R_2 = \frac{68.845}{V_a - V_o} - R_s \quad \text{k}\Omega$$

Where,  $V_o$  = Original output voltage  
 $V_a$  = Adjusted output voltage  
 $R_s$  = Internal resistance (Table 1)

### Notes:

1. Use only a single 1% resistor in either the ( $R_1$ ) or  $R_2$  location. Place the resistor as close to the ISR as possible.
2. Never connect capacitors to  $V_o$  adjust. Any capacitance added to the  $V_o$  adjust control pin will affect the stability of the ISR.
3. The output power is limited to 10W. If the output voltage is increased, the maximum load current must be derated according to the following equation.

$$I_o(\text{max}) = \frac{10}{V_a}$$

In any instance, the load current must not exceed the converter's rated current (See Table 1).

**Table 1**

**DC/DC CONVERTER ADJUSTMENT RANGE AND FORMULA PARAMETERS**

Series Pt #	PT4247	PT4246	PT4241	PT4245	PT4242	PT4243	PT4244
24V Bus	PT4247	PT4246	PT4241	PT4245	PT4242	PT4243	PT4244
48V Bus	PT4227	PT4226	PT4221	PT4225	PT4222	PT4223	PT4224
Rated Current <sup>3</sup>	3A	3A	3A	3A	3A	2A	0.85A
$V_o(\text{nom})$	1.3V	1.5V	1.8V	2.5V	3.3V	5.0V	12.0V
$V_o(\text{min})$	1.2V	1.45V	1.7V	2.25V	2.95V	4.5V	10.8V
$V_o(\text{max})$	1.4V	1.65V	1.98V	2.75V	3.65V	5.5V	13.2V
$R_s$ (k $\Omega$ )	340.0	243.0	243.0	187.0	187.0	110.0	49.9

**Figure 1**

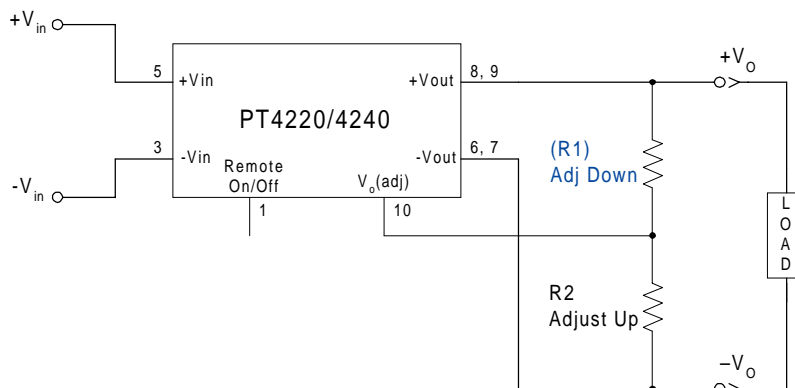

PT4220/4240 Series

**Table 2**

**DC/DC CONVERTER ADJUSTMENT RESISTOR VALUES**

Series Pt #							
24V Bus	PT4247	PT4246	PT4241	PT4245	PT4242	PT4243	PT4244
48V Bus	PT4227	PT4226	PT4221	PT4225	PT4222	PT4223	PT4224
<b>V<sub>o</sub>(nom)</b>	1.3V	1.5V	1.8V	2.5V	3.3V	5.0V	12.0V
<b>V<sub>a</sub>(req'd)</b>						<b>V<sub>a</sub>(req'd)</b>	
1.2	(0.0)kΩ					4.5	(258.0)kΩ
1.25	(340.0)kΩ					4.6	(364.0)kΩ
1.3						4.7	(541.0)kΩ
1.35	340.0kΩ					4.8	(895.0)kΩ
1.4	0.0.0kΩ					4.9	(1960.0)kΩ
1.45		(9.9)kΩ				5.0	
1.5						5.1	578.0kΩ
1.55		1130.0kΩ				5.2	234.0kΩ
1.6		445.0kΩ				5.3	119.0kΩ
1.65		216.0kΩ				5.4	62.1kΩ
1.7			(23.9)kΩ			5.5	27.7kΩ
1.75			(347.0)kΩ			10.8	(399.0)kΩ
1.8						11.0	(499.0)kΩ
1.85			1130.0kΩ			11.5	(1110.0)kΩ
1.9			445.0kΩ			12.0	
1.95			216.0kΩ			12.5	87.8kΩ
2.25				(43.4)kΩ		13.0	18.9kΩ
2.3				(115.0)kΩ		13.2	7.5kΩ
2.35				(235.0)kΩ			
2.4				(473.0)kΩ			
2.45				(1190.0)kΩ			
2.5							
2.55				1190.0kΩ			
2.6				501.0kΩ			
2.65				272.0kΩ			
2.7				157.0kΩ			
2.75				88.4kΩ			
2.95					(90.0)kΩ		
3.0					(146.0)kΩ		
3.05					(223.0)kΩ		
3.1					(340.0)kΩ		
3.15					(534.0)kΩ		
3.2					(923.0)kΩ		
3.25					(2090.0)kΩ		
3.3							
3.35					1190.0kΩ		
3.4					501.0kΩ		
3.45					272.0kΩ		
3.5					157.0kΩ		
3.55					88.4kΩ		
3.6					42.5kΩ		
3.65					9.7kΩ		

R<sub>1</sub> = (Blue)      R<sub>2</sub> = Black

## IMPORTANT NOTICE

Texas Instruments Incorporated and its subsidiaries (TI) reserve the right to make corrections, modifications, enhancements, improvements, and other changes to its products and services at any time and to discontinue any product or service without notice. Customers should obtain the latest relevant information before placing orders and should verify that such information is current and complete. All products are sold subject to TI's terms and conditions of sale supplied at the time of order acknowledgment.

TI warrants performance of its hardware products to the specifications applicable at the time of sale in accordance with TI's standard warranty. Testing and other quality control techniques are used to the extent TI deems necessary to support this warranty. Except where mandated by government requirements, testing of all parameters of each product is not necessarily performed.

TI assumes no liability for applications assistance or customer product design. Customers are responsible for their products and applications using TI components. To minimize the risks associated with customer products and applications, customers should provide adequate design and operating safeguards.

TI does not warrant or represent that any license, either express or implied, is granted under any TI patent right, copyright, mask work right, or other TI intellectual property right relating to any combination, machine, or process in which TI products or services are used. Information published by TI regarding third-party products or services does not constitute a license from TI to use such products or services or a warranty or endorsement thereof. Use of such information may require a license from a third party under the patents or other intellectual property of the third party, or a license from TI under the patents or other intellectual property of TI.

Reproduction of information in TI data books or data sheets is permissible only if reproduction is without alteration and is accompanied by all associated warranties, conditions, limitations, and notices. Reproduction of this information with alteration is an unfair and deceptive business practice. TI is not responsible or liable for such altered documentation.

Resale of TI products or services with statements different from or beyond the parameters stated by TI for that product or service voids all express and any implied warranties for the associated TI product or service and is an unfair and deceptive business practice. TI is not responsible or liable for any such statements.

### Mailing Address:

Texas Instruments  
Post Office Box 655303  
Dallas, Texas 75265

Copyright © Each Manufacturing Company.

All Datasheets cannot be modified without permission.

This datasheet has been download from :

[www.AllDataSheet.com](http://www.AllDataSheet.com)

100% Free DataSheet Search Site.

Free Download.

No Register.

Fast Search System.

[www.AllDataSheet.com](http://www.AllDataSheet.com)