

# PT480/PT480F

## Narrow Acceptance Phototransistor

### ■ Features

1. Epoxy resin package
2. Narrow acceptance ( $\Delta\theta$  : TYP.  $\pm 13^\circ$ )
3. Visible light cut-off type : **PT480F**

### ■ Applications

1. VCRs, cassette tape recorders
2. Floppy disk drives
3. Optoelectronic switches
4. Automatic stroboscopes

### ■ Outline Dimensions

(Unit : mm)

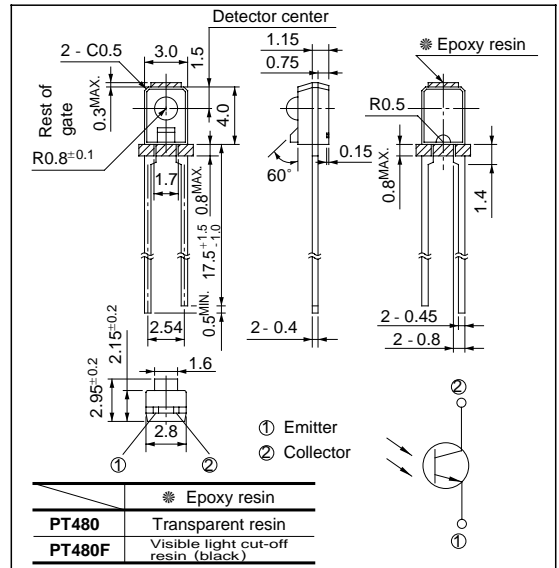

### ■ Absolute Maximum Ratings

(Ta = 25°C)

Parameter	Symbol	Rating	Unit
Collector-emitter voltage	V <sub>CEO</sub>	35	V
Emitter-collector voltage	V <sub>ECO</sub>	6	V
Collector current	I <sub>C</sub>	20	mA
Collector power dissipation	P <sub>C</sub>	75	mW
Operating temperature	T <sub>opr</sub>	- 25 to + 85	°C
Storage temperature	T <sub>stg</sub>	- 40 to + 85	°C
*1 Soldering temperature	T <sub>sol</sub>	260	°C

\*1 For 5 seconds at the position of 1.4mm from the bottom face of resin package

### ■ Electro-optical Characteristics

(Ta = 25°C)

Parameter	Symbol	Conditions	MIN.	TYP.	MAX.	Unit
*2 Collector current	I <sub>C</sub>	V <sub>CE</sub> = 5V	0.4	1.7	6.0	mA
		E <sub>e</sub> = 1mW/cm <sup>2</sup>	0.25	0.8	3.0	mA
Collector dark current	I <sub>CEO</sub>	V <sub>CE</sub> = 20V, E <sub>e</sub> = 0	-	10 <sup>-9</sup>	10 <sup>-7</sup>	A
*2 Collector-emitter saturation voltage	V <sub>CE(sat)</sub>	I <sub>C</sub> = 0.5mA, E <sub>e</sub> = 10mW/cm <sup>2</sup>	-	0.1	0.4	V
Peak sensitivity wavelength	λ <sub>P</sub>	-	-	800	-	nm
			-	860	-	nm
Response time	Rise time	V <sub>CE</sub> = 2V, I <sub>C</sub> = 2mA	-	3	-	μs
	Fall time	R <sub>L</sub> = 100Ω	-	3.5	-	μs

\*2 E<sub>e</sub> : Irradiance by CIE standard light source A (tungsten lamp)

**Fig. 1 Collector Power Dissipation vs. Ambient Temperature**

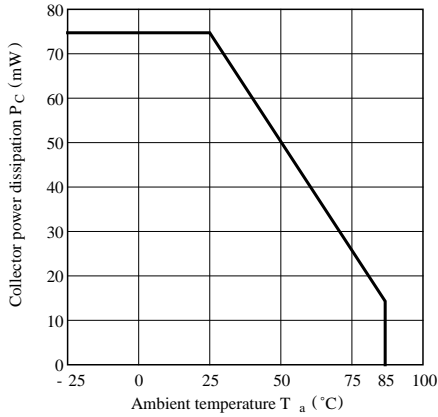

**Fig. 2 Collector Dark Current vs. Ambient Temperature**

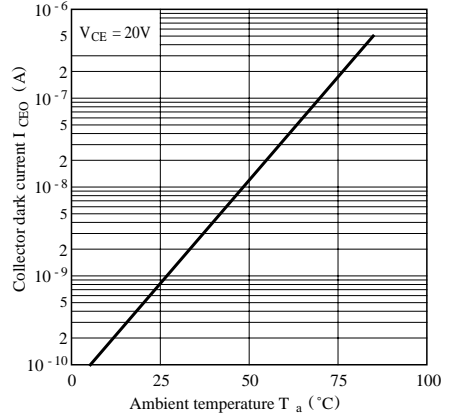

**Fig. 3 Relative Collector Current vs. Ambient Temperature**

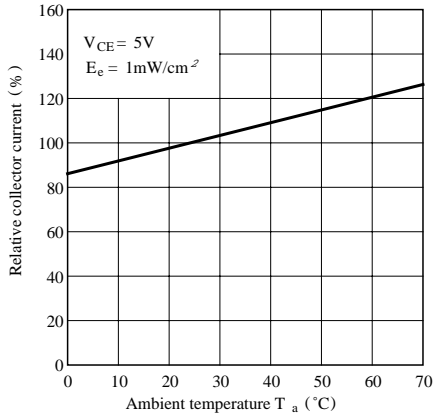

**Fig.4-a Collector Current vs. Irradiance (PT480)**

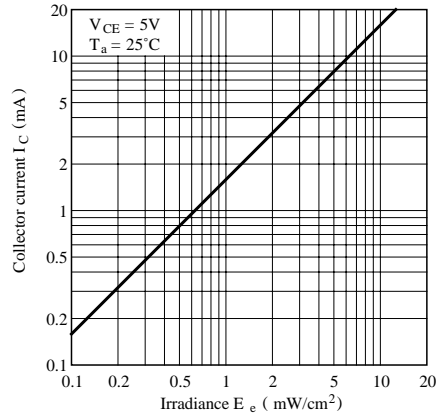

**Fig.4-b Collector Current vs. Irradiance (PT480F)**

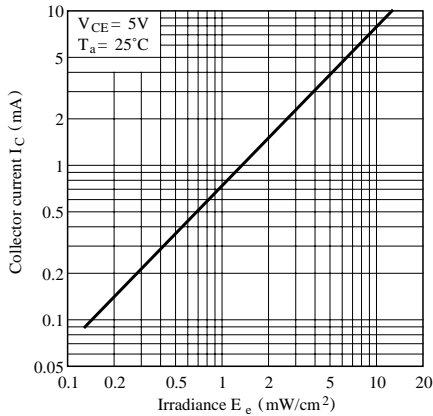

**Fig.5-a Collector Current vs. Collector-emitter Voltage (PT480)**

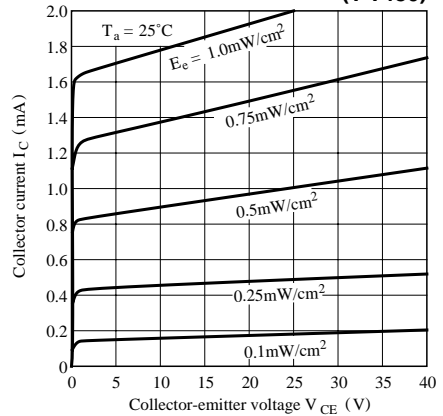

**Fig.5-b Collector Current vs. Collector-emitter Voltage (PT480F)**

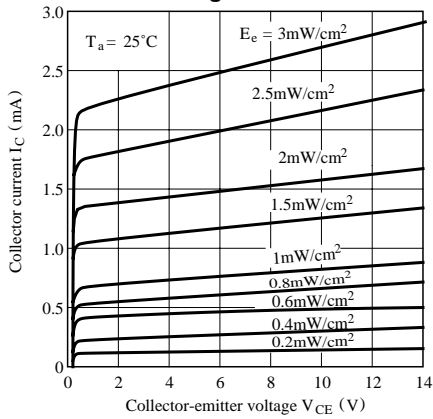

**Fig. 6 Spectral Sensitivity**

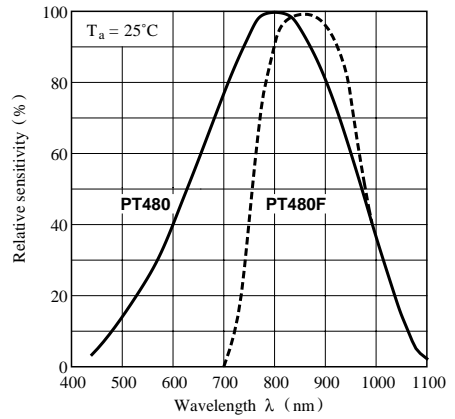

**Fig. 7 Response Time vs. Load Resistance**

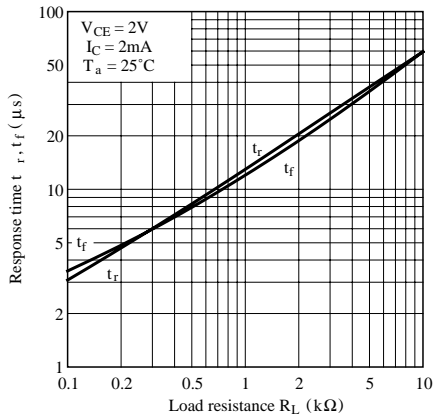

**Test Circuit for Response Time**

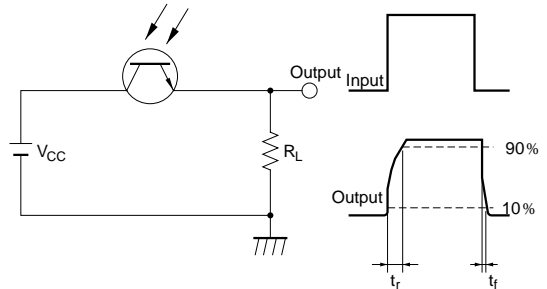

**Fig. 8 Sensitivity Diagram (T\_a = 25°C)**

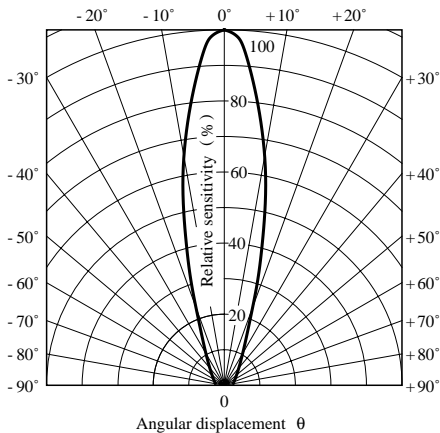

**Fig.9-a Collector-emitter Saturation Voltage vs. Irradiance (PT480)**

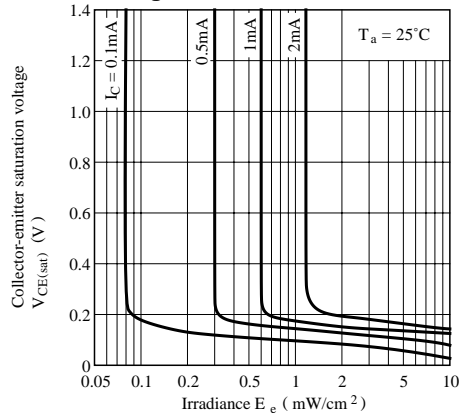

**Fig.9-b Collector-emitter Saturation Voltage vs. Irradiance (PT480F)**

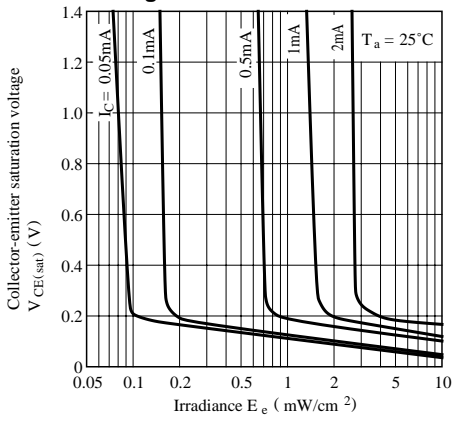

**Fig.10 Relative Output vs. Distance (Emitter : GL480)**

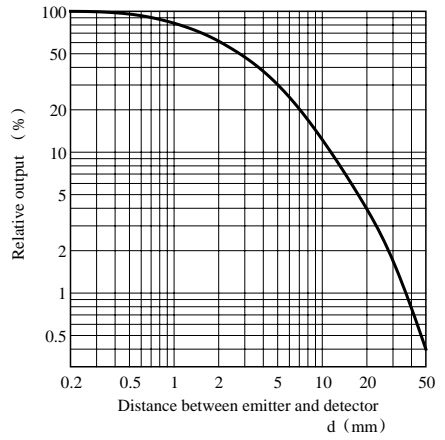

Please refer to the chapter "Precautions for Use."