

## PT5540 Series

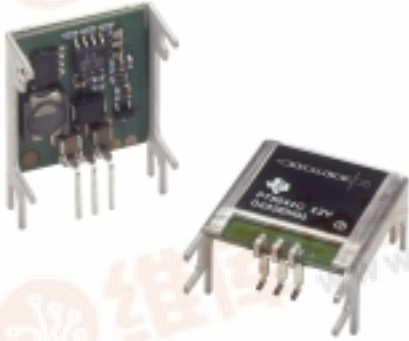

### 12-W 5-V Input Step-Up (Boost) Integrated Switching Regulator

SLTS175 FEBRUARY 2003



#### Features

- Input Voltage: 5V
- 84% Efficiency
- Industrial Temperature Range: -40°C to +85°C
- Under-Voltage Lockout
- Soft Start
- Small Footprint: 0.94in × 0.35in (Vertical package)
- Solderable Copper Case
- Surface Mountable
- IPC Lead Free 2

#### Description

The PT5540 Excalibur™ power modules are a series of integrated switching regulators (ISRs) that provide a boost-voltage function. They are designed for use with +5V bus systems that require an additional higher voltage rail.

The modules are rated 12W and produce a fixed output voltage over the full industrial temperature range of -40°C to +85°C. The series includes the common output voltages, +12V and +15V. Applications include PCI cards, audio circuits, and battery operated instruments.

The PT5540 series is packaged in a 3-pin thermally efficient copper case. The case is solderable, has a small footprint, and can accommodate both through-hole and surface mount pin configurations.

The PT5540 series is offered as a next generation replacement to the popular PT5040 series. The PT5540 has a lower operating temperature range and improved start-up characteristics.

#### Ordering Information

|         |               |
|---------|---------------|
| PT5541□ | = +12 Volts   |
| PT5542□ | = +15 Volts   |
| PT5544□ | = + 8 Volts   |
| PT5545□ | = + 9 Volts   |
| PT5546□ | = +10 Volts   |
| PT5548□ | = +12.6 Volts |

#### Pin-Out Information

| Pin | Function        |
|-----|-----------------|
| 1   | V <sub>in</sub> |
| 2   | GND             |
| 3   | V <sub>o</sub>  |

#### PT Series Suffix (PT1234 x)

| Case/Pin Configuration | Order Suffix | Package Code |
|------------------------|--------------|--------------|
| Vertical               | <b>N</b>     | (EFN)        |
| Horizontal             | <b>A</b>     | (EFP)        |
| SMD                    | <b>C</b>     | (EFQ)        |

(Reference the applicable package code drawing for the dimensions and PC board layout)

#### Standard Application

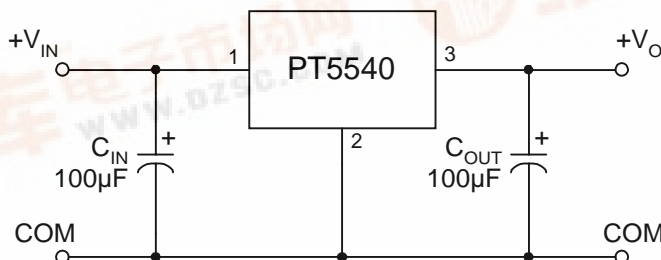

C<sub>IN</sub> = Required 100µF electrolytic  
 C<sub>OUT</sub> = Required 100µF electrolytic (not to exceed 560µF)



# PT5540 Series

## 12-W 5-V Input Step-Up (Boost) Integrated Switching Regulator

SLTS175 FEBRUARY 2003

### Specifications (Unless otherwise stated, $T_a = 25^\circ\text{C}$ , $V_{in} = 5\text{V}$ , $C_{in} = 100\mu\text{F}$ , $C_{out} = 100\mu\text{F}$ , and $I_o = I_{o,max}$ )

| Characteristics             | Symbols                          | Conditions   |  | PT5540 SERIES                                  |                            |                                 | Units                      |
|-----------------------------|----------------------------------|--|--|--|----------------------------|---------------------------------|----------------------------|
|                             |                                  |  |  | Min  | Typ                        | Max                             |                            |
| Output Current              | $I_o$                            | Over $V_{in}$ range  | PT5541/8<br>PT5542<br>PT5544<br>PT5545<br>PT5546 | 0.1 <sup>(1)</sup><br>0.1<br>0.1<br>0.1<br>0.1 | —<br>—<br>—<br>—<br>—      | 1<br>0.75<br>1.75<br>1.5<br>1.3 | A                          |
| Input Voltage Range         | $V_{in}$                         | Over $I_o$ range   | $V_o > 10\text{V}$<br>$V_o \leq 10\text{V}$      | 4.5<br>4.5                                     | —                          | 9<br>( $V_o - 1$ )              | V                          |
| Set-Point Voltage Tolerance | $V_o \text{ tol}$                |  |  | —  | —                          | $\pm 2$                         | $\%V_o$                    |
| Temperature Variation       | $\Delta\text{Reg}_{\text{temp}}$ | $-40^\circ\text{C} < T_a < +85^\circ\text{C}$ , $I_o = I_{o,min}$                      |  | —  | $\pm 0.5$                  | —                               | $\%V_o$                    |
| Line Regulation             | $\Delta\text{Reg}_{\text{line}}$ | Over $V_{in}$ range  |  | —  | —                          | $\pm 0.5$                       | $\%V_o$                    |
| Load Regulation             | $\Delta\text{Reg}_{\text{load}}$ | Over $I_o$ range   |  | —  | —                          | $\pm 0.5$                       | $\%V_o$                    |
| Total Output Variation      | $\Delta\text{Reg}_{\text{tot}}$  | Includes set-point, line, load,<br>$-40^\circ\text{C} \leq T_a \leq +85^\circ\text{C}$ |  | —  | $\pm 3$                    | —                               | $\%V_o$                    |
| Efficiency                  | $\eta$                           | $I_o = 75\%$ of $I_{o,max}$  | PT5541/8<br>PT5542<br>PT5544<br>PT5545<br>PT5546 | —<br>—<br>—<br>—<br>—                          | 84<br>84<br>86<br>86<br>86 | —<br>—<br>—<br>—<br>—           | %                          |
| $V_o$ Ripple (pk-pk)        | $V_r$                            | 20MHz bandwidth  |  | —  | 2                          | 5                               | $\%V_o$                    |
| Transient Response          | $t_{tr}$<br>$\Delta V_{tr}$      | 1A/ $\mu\text{s}$ load step, 50% of $I_{o,max}$<br>$V_o$ over/undershoot               |  | —<br>—   | 150<br>1                   | —<br>3                          | $\mu\text{Sec}$<br>$\%V_o$ |
| Under-Voltage Lockout       | UVLO                             | $V_{in}$ increasing<br>Hysteresis  |  | —<br>0.1                                       | 4.3<br>0.2                 | —<br>—                          | V                          |
| Start-up Current            | $I_{in,start}$                   | On start up, $C_{out} = 560\mu\text{F}$  |  | —  | $I_{in} + 0.5$             | —                               | A                          |
| Switching Frequency         | $f_o$                            | Over $V_{in}$ and $I_o$ ranges   |  | 300  | 350                        | 400                             | kHz                        |
| External Capacitance        | $C_{in}$<br>$C_{out}$            |  |  | 100 <sup>(3)</sup><br>100 <sup>(3)</sup>       | —<br>—                     | —<br>560                        | $\mu\text{F}$              |
| Operating Temperature Range | $T_a$                            | Over $V_{in}$ range  |  | $-40$ <sup>(4)</sup>                           | —                          | $+85$ <sup>(5)</sup>            | $^\circ\text{C}$           |
| Storage Temperature         | $T_s$                            | —  |  | $-40$  | —                          | $+125$                          | $^\circ\text{C}$           |
| Mechanical Shock            |                                  | Per Mil-STD-883D, Method 2002.3, 1 msec,<br>Half Sine, mounted to a fixture            |  | —  | 500                        | —                               | G's                        |
| Mechanical Vibration        |                                  | Per Mil-STD-883D, Method 2007.2,<br>20-2000 Hz, Soldered in a PC board                 |  | —  | 20 <sup>(6)</sup>          | —                               | G's                        |
| Weight                      | —                                | —  |  | —  | 6.5                        | —                               | grams                      |
| Flammability                | —                                | Materials meet UL 94V-0  |  | —  | —                          | —                               | —                          |

**Notes:** (1) The ISR will operate down to no load with reduced specifications.

(2) Boost topology ISRs are not short circuit protected.

(3) The PT5540 Series requires a 100 $\mu\text{F}$  electrolytic or tantalum capacitor at both the input and output for proper operation in all applications.

(4) For operation below  $0^\circ\text{C}$ , the output capacitor  $C_2$  must have stable characteristics. Use either a low ESR tantalum or Oscon<sup>®</sup> capacitor.

(5) See SOA curves or consult factory for the appropriate derating.

(6) The case pins on the through-hole package types (suffixes N & A) must be soldered. For more information see the applicable package outline drawing.

**PT5541, 12VDC** (See Note A)

**PT5542, 15VDC** (See Note A)

**PT5545, 9VDC** (See Note A)

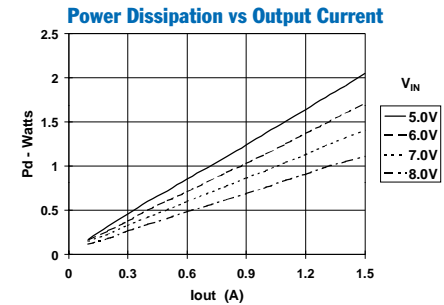
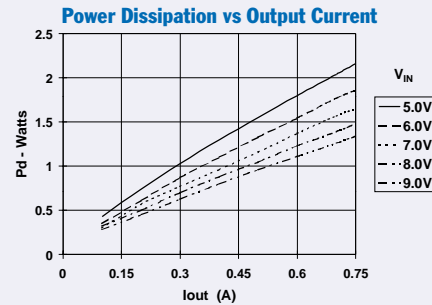
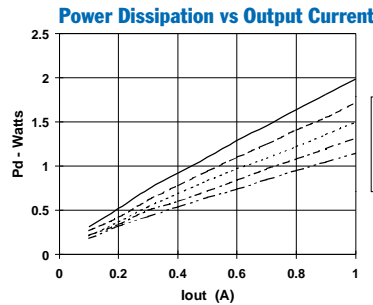
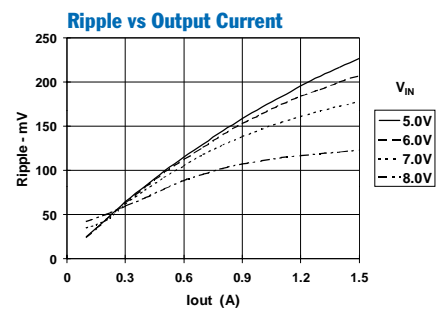
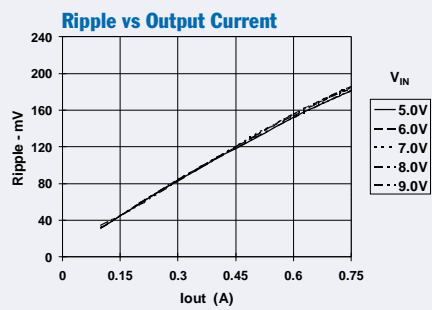
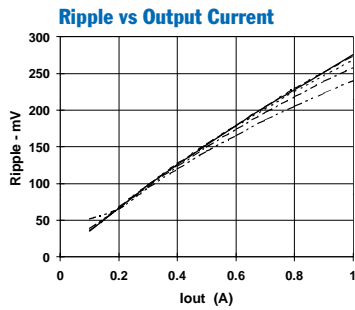
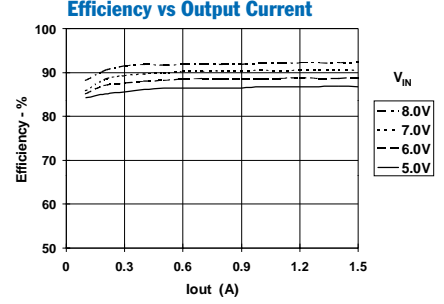
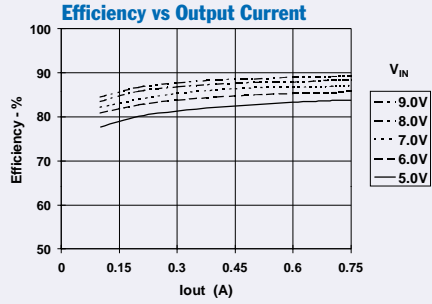
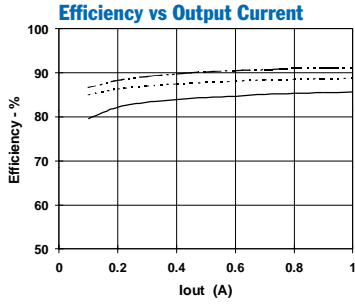

**Safe Operating Area;  $V_{in} = 5V$**  (See Note B)

**Safe Operating Area;  $V_{in} = 5V$**  (See Note B)

**Safe Operating Area;  $V_{in} = 5V$**  (See Note B)

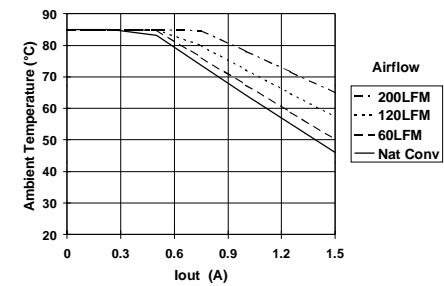
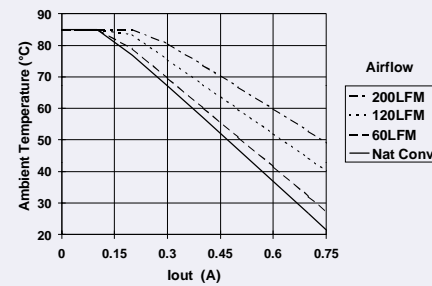
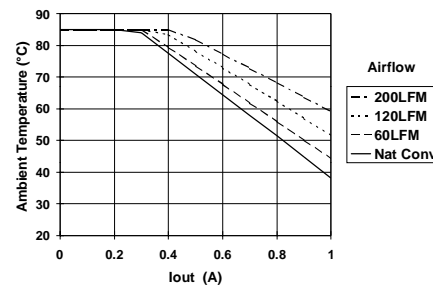

**Note A:** Characteristic data has been developed from actual products tested at 25°C. This data is considered typical data for the ISR.

**Note B:** SOA curves represent operating conditions at which internal components are at or below manufacturer's maximum rated operating temperatures.

### Capacitor Recommendations for the PT5540 Boost Regulator Regulator Series

#### Input Capacitors:

The minimum input capacitance required is 100µF, with a 200-mA(rms) ripple current rating and 150mΩ typical equivalent series resistance (ESR). Electrolytic capacitors have marginal ripple performance at frequencies greater than 400kHz but have excellent low-frequency transient response. Above the ripple frequency, ceramic capacitors are necessary to improve the transient response and reduce any high frequency noise components apparent during higher current excursions. Preferred ESR type capacitor part numbers are identified in Table 2-1.

#### Output Capacitor:

The recommended output capacitance is determined by 0.5-A(rms) ripple current rating and 100µF minimum capacitance. The maximum output capacitance is 560µF.

Ripple current and >50mΩ ESR value are the major considerations, along with temperature, when designing with different types of capacitors. Tantalum capacitors have a recommended minimum voltage rating of 2 × (the maximum DC voltage + AC ripple). This is necessary to insure reliability for input voltage bus applications.

#### Tantalum Capacitors (Optional Input Capacitors)

Tantalum type capacitors can be used for the input bus but only the AVX TPS, Sprague 593D/594/595, or Kemet T495/T510 series. These capacitors are recommended over many other tantalum types due to their higher rated surge, power dissipation, and ripple current capability. As a caution the TAJ series by AVX is not recommended. This series has considerably higher ESR, reduced power dissipation, and lower ripple current capability. The TAJ series is less reliable than the AVX TPS series when determining power dissipation capability. Tantalum or Oscon® types are recommended for applications where ambient temperatures fall below 0°C. Do not use tantalum capacitors on the output bus.

#### Capacitor Table

Table 1 identifies the characteristics of capacitors from a number of vendors with acceptable ESR and ripple current ratings. The number of capacitors required at both the input and output buses is identified for each capacitor type.

*This is not an extensive capacitor list. Capacitors from other vendors are available with comparable specifications. Those listed are for guidance. The RMS ripple current rating and ESR (Equivalent Series Resistance at 100kHz) are critical parameters necessary to insure both optimum regulator performance and long capacitor life.*

**Table 1: Input/Output Capacitors**

| Capacitor Vendor/<br>Series                             | Capacitor Characteristics |           |                                    |                                    |                      | Quantity  |            | Vendor Part Number         |
|---|---------------------------|-----------|------------------------------------|------------------------------------|----------------------|-----------|------------|----------------------------|
|   | Working Voltage           | Value(µF) | (ESR) Equivalent Series Resistance | 105°C Maximum Ripple Current(Irms) | Physical Size(mm)    | Input Bus | Output Bus |                            |
| Panasonic<br>FC (Radial)<br>(Surface Mtg).....          | 35V                       | 100       | 0.117Ω                             | 555mA                              | 8x11.5               | 1         | 1          | EEUFC1V101                 |
|   | 25V                       | 330       | 0.090Ω                             | 755mA                              | 10x12.5              | 1         | 1          | EEUFC1E331                 |
|   | 35V                       | 100       | 0.150Ω                             | 670mA                              | 10x10.2              | 1         | 1          | EEVFC1V101P                |
| FC/FK (Surface Mtg)                                     | 35V                       | 100       | 0160Ω                              | 600mA                              | 8x10.2               | 1         | 1          | EEVFK1V101P                |
| United Chemi-con<br>LXZ/LXV Series<br>MVY (Surface Mtg) | 35V                       | 150       | 0.120Ω                             | 555mA                              | 8x12                 | 1         | 1          | LXZ35VB151M8X12LL          |
|   | 25V                       | 220       | 0.120Ω                             | 555mA                              | 8x12                 | 1         | 1          | LXZ25VB221M8X12LL          |
|   | 25V                       | 330       | 0.150Ω                             | 670mA                              | 10x10.3              | 1         | 1          | MVY25VC331M10X10TP         |
| Nichicon<br>PM Series                                   | 35V                       | 120       | 0.150Ω                             | 555mA                              | 10x12.5              | 1         | 1          | UPM1V121MPH6               |
|   | 25V                       | 180       | 0.150Ω                             | 555mA                              | 10x12.5              | 1         | 1          | UPM1E181MPH6               |
| NX  | 16V                       | 150       | 0.026Ω                             | 3300mA                             | 10x8                 | 1         | N/R (1)    | PNX1C151MCR1GS             |
| Os-con:<br>SP<br>SVP (surface Mount)                    | 20V                       | 120       | 0.024Ω                             | 3100mA                             | 8x10.5               | 1         | N/R (1)    | 20SP120M(No Vout)          |
|   | 20V                       | 100       | 0.024Ω                             | 3320mA                             | 8x12                 | 1         | N/R (1)    | 20SVP100M(No Vout)         |
| AVX Tantalum<br>TPS (Surface Mtgt)                      | 16V                       | 100       | 0.125Ω                             | >1149mA                            | 7.3L                 | 1         | N/R (1)    | TPSE107M016R0125(No Vout)  |
|   | 20V                       | 100       | 0.200Ω                             | >1118mA                            | ×7.3L<br>×4.1H       | 1         | N/R (1)    | TPSV107M016R0200 (No Vout) |
| Kemet Tantalum<br>T520/T495 Series<br>(Surface Mount)   | 10V                       | 100       | 0.080Ω                             | 1700mA                             | 4.3W                 | 1         | N/R (1)    | T520D107M010AS(No Vout)    |
|   | 10V                       | 100       | 0.100Ω                             | >100mA                             | ×7.3L<br>×4.0H       | 1         | N/R (1)    | T495X107M010AS(No Vout)    |
| Sprague Tantalum<br>594D Series<br>(Surface Mount)      | 16V                       | 100       | 0.075Ω                             | 1410mA                             | 7.2L<br>×6W<br>×4.1H | 1         | N/R (1)    | 594D107X0016D2T            |

(1) N/R –Not recommended. The surge and normal voltage rating does not meet the minimum operating limits.

## Features and System Considerations for the PT5540 Series of Boost ISRs

### Boost Regulator Topology and Characteristics

Figure 1-1 shows a block diagram of the boost regulator circuit, which is representative of the PT5540 ISR series. Note that when the MOSFET switch is off, the output regulator is connected directly to the input via an inductor and schottky diode. Thus with the MOSFET switch inactive, the output voltage merely tracks the input voltage, less the forward voltage drop of the diode.

**Figure 1-1; Boost Regulator Block Diagram**

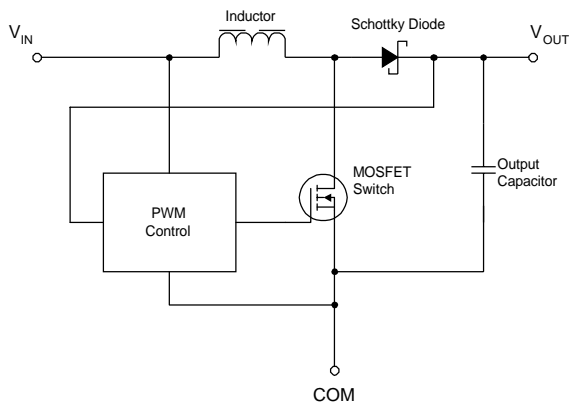

One of the characteristic of a boost regulator is that its input current is always higher than its output current. For example, a 12-W rated 5V to 12V boost regulator, operating at 80% efficiency, will demand 15W of input power. Thus a 1-A load on the regulator's output will correlate to 3-A of input current from its source. And any fall (droop) in the input voltage will correspondingly result in the input current rising further. The input current demanded by a boost regulator is therefore high, making it important that the regulator be connected to a low impedance source.

### Under-Voltage Lockout (UVLO)

The PT5540 series of boost regulators incorporate an input under-voltage lockout (UVLO). The UVLO prevents operation of the regulator until the input voltage is above the UVLO threshold (see data sheet specifications). This prevents the regulator from drawing a high startup current during power up, and minimizes the current drain from the input source during low input voltage conditions.

*Note: Below the UVLO threshold, the regulator's internal MOSFET is merely held 'off', disabling its boost function. Under this condition the regulator will still produce an output voltage. This is the input voltage less the forward voltage drop of the internal schottky diode.*

### Soft-Start Power Up

When the input source voltage rises above the UVLO threshold voltage the regulator will initiate a soft-start power up. The soft-start circuitry introduces a short time delay and slows the rate at which the output rises to full regulation voltage. Figure 1-2 shows the power-up characteristic of a PT5542 (15V) regulator. After the application of the input voltage,  $V_{in}$ , there is a delay of approximately 100ms before the output voltage rises above the input voltage. This delay provides more time for a slow rising input source to reach the minimum operating voltage of 4.5V. The waveforms of Figure 1-2 were measured with a 5Vdc input voltage and 0.5-Adc constant current load.

**Figure 1-2; Typical Power Up Waveforms for the PT5542**

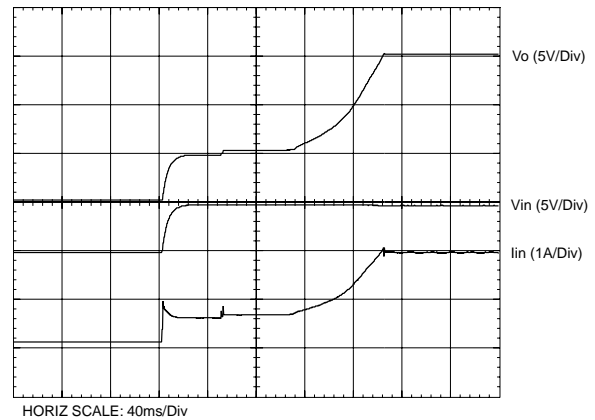

### Input Source Requirements

As the input current is much higher than the output load current, boost regulators are sensitive to source voltage impedance. This is especially during power up when a regulator attempts to start at too low an input voltage. The UVLO built into the PT5540 series reduces the input current during startup by disabling the boost function until the source voltage has almost reached the minimum operating voltage of 4.5V. However, the UVLO circuitry will also promptly switch off the regulator if this voltage sags as the input current rises. This is often described as a "hiccup" effect. The module may hiccup at power up due to a combination of two conditions. The input voltage is rising too slowly and its source impedance is not low enough. To ensure a clean power-up the output impedance of the input source should be less than 25mΩ. A higher input impedance can be tolerated if the input voltage rises promptly and regulates closer to the nominal input voltage of 5V.

#### **Fault Protection**

Unlike a “Buck” or step-down regulator it is not possible to provide a boost regulator with short-circuit protection. As revealed in the block diagram of Figure 1-1, inhibiting the MOSFET switching action only disables the regulator’s boost function. Therefore under a severe output impedance fault the control circuit cannot disconnect the output from the input source.

To prevent an output over-current or short-circuit fault from propagating to the input bus, a fuse or equivalent over-current protection is recommended at the input of the module. Whatever form of protection is selected, it is important to note that the impedance and/or voltage drop of the series element will add to the regulator’s minimum input voltage requirements. Power up may also be affected. The combination of an input surge current with an impedance in series with the regulator input may cause the input voltage to momentarily dip back below the UVLO threshold. Ensure that the fuse rating or input current limit threshold are designed with a generous margin.

**PACKAGING INFORMATION**

| Orderable Device | Status <sup>(1)</sup> | Package Type | Package Drawing | Pins | Package Qty | Eco Plan <sup>(2)</sup> | Lead/Ball Finish | MSL Peak Temp <sup>(3)</sup> |
|------------------|-----------------------|--------------|-----------------|------|-------------|-------------------------|------------------|------------------------------|
| PT5541A          | ACTIVE                | SIP MOD ULE  | EFP             | 3    | 30          | TBD                     | Call TI          | Level-1-215C-UNLIM           |
| PT5541C          | ACTIVE                | SIP MOD ULE  | EFQ             | 3    | 30          | TBD                     | Call TI          | Level-3-215C-168HRS          |
| PT5541N          | ACTIVE                | SIP MOD ULE  | EFN             | 3    | 30          | TBD                     | Call TI          | Level-1-215C-UNLIM           |
| PT5542C          | ACTIVE                | SIP MOD ULE  | EFQ             | 3    | 30          | TBD                     | Call TI          | Level-3-215C-168HRS          |
| PT5544A          | NRND                  | SIP MOD ULE  | EFP             | 3    | 30          | TBD                     | Call TI          | Level-1-215C-UNLIM           |
| PT5544C          | ACTIVE                | SIP MOD ULE  | EFQ             | 3    | 30          | TBD                     | Call TI          | Level-3-215C-168HRS          |
| PT5545N          | NRND                  | SIP MOD ULE  | EFN             | 3    | 30          | TBD                     | Call TI          | Level-1-215C-UNLIM           |

<sup>(1)</sup> The marketing status values are defined as follows:

**ACTIVE:** Product device recommended for new designs.

**LIFEBUY:** TI has announced that the device will be discontinued, and a lifetime-buy period is in effect.

**NRND:** Not recommended for new designs. Device is in production to support existing customers, but TI does not recommend using this part in a new design.

**PREVIEW:** Device has been announced but is not in production. Samples may or may not be available.

**OBSOLETE:** TI has discontinued the production of the device.

<sup>(2)</sup> Eco Plan - The planned eco-friendly classification: Pb-Free (RoHS) or Green (RoHS & no Sb/Br) - please check <http://www.ti.com/productcontent> for the latest availability information and additional product content details.

**TBD:** The Pb-Free/Green conversion plan has not been defined.

**Pb-Free (RoHS):** TI's terms "Lead-Free" or "Pb-Free" mean semiconductor products that are compatible with the current RoHS requirements for all 6 substances, including the requirement that lead not exceed 0.1% by weight in homogeneous materials. Where designed to be soldered at high temperatures, TI Pb-Free products are suitable for use in specified lead-free processes.

**Green (RoHS & no Sb/Br):** TI defines "Green" to mean Pb-Free (RoHS compatible), and free of Bromine (Br) and Antimony (Sb) based flame retardants (Br or Sb do not exceed 0.1% by weight in homogeneous material)

<sup>(3)</sup> MSL, Peak Temp. -- The Moisture Sensitivity Level rating according to the JEDEC industry standard classifications, and peak solder temperature.

**Important Information and Disclaimer:**The information provided on this page represents TI's knowledge and belief as of the date that it is provided. TI bases its knowledge and belief on information provided by third parties, and makes no representation or warranty as to the accuracy of such information. Efforts are underway to better integrate information from third parties. TI has taken and continues to take reasonable steps to provide representative and accurate information but may not have conducted destructive testing or chemical analysis on incoming materials and chemicals. TI and TI suppliers consider certain information to be proprietary, and thus CAS numbers and other limited information may not be available for release.

In no event shall TI's liability arising out of such information exceed the total purchase price of the TI part(s) at issue in this document sold by TI to Customer on an annual basis.

## IMPORTANT NOTICE

Texas Instruments Incorporated and its subsidiaries (TI) reserve the right to make corrections, modifications, enhancements, improvements, and other changes to its products and services at any time and to discontinue any product or service without notice. Customers should obtain the latest relevant information before placing orders and should verify that such information is current and complete. All products are sold subject to TI's terms and conditions of sale supplied at the time of order acknowledgment.

TI warrants performance of its hardware products to the specifications applicable at the time of sale in accordance with TI's standard warranty. Testing and other quality control techniques are used to the extent TI deems necessary to support this warranty. Except where mandated by government requirements, testing of all parameters of each product is not necessarily performed.

TI assumes no liability for applications assistance or customer product design. Customers are responsible for their products and applications using TI components. To minimize the risks associated with customer products and applications, customers should provide adequate design and operating safeguards.

TI does not warrant or represent that any license, either express or implied, is granted under any TI patent right, copyright, mask work right, or other TI intellectual property right relating to any combination, machine, or process in which TI products or services are used. Information published by TI regarding third-party products or services does not constitute a license from TI to use such products or services or a warranty or endorsement thereof. Use of such information may require a license from a third party under the patents or other intellectual property of the third party, or a license from TI under the patents or other intellectual property of TI.

Reproduction of information in TI data books or data sheets is permissible only if reproduction is without alteration and is accompanied by all associated warranties, conditions, limitations, and notices. Reproduction of this information with alteration is an unfair and deceptive business practice. TI is not responsible or liable for such altered documentation.

Resale of TI products or services with statements different from or beyond the parameters stated by TI for that product or service voids all express and any implied warranties for the associated TI product or service and is an unfair and deceptive business practice. TI is not responsible or liable for any such statements.

Following are URLs where you can obtain information on other Texas Instruments products and application solutions:

| <b>Products</b>  |  | <b>Applications</b> |  |
|------------------|--|---------------------|--|
| Amplifiers       | <a href="http://amplifier.ti.com">amplifier.ti.com</a>             | Audio               | <a href="http://www.ti.com/audio">www.ti.com/audio</a>                   |
| Data Converters  | <a href="http://dataconverter.ti.com">dataconverter.ti.com</a>     | Automotive          | <a href="http://www.ti.com/automotive">www.ti.com/automotive</a>         |
| DSP              | <a href="http://dsp.ti.com">dsp.ti.com</a>                         | Broadband           | <a href="http://www.ti.com/broadband">www.ti.com/broadband</a>           |
| Interface        | <a href="http://interface.ti.com">interface.ti.com</a>             | Digital Control     | <a href="http://www.ti.com/digitalcontrol">www.ti.com/digitalcontrol</a> |
| Logic            | <a href="http://logic.ti.com">logic.ti.com</a>                     | Military            | <a href="http://www.ti.com/military">www.ti.com/military</a>             |
| Power Mgmt       | <a href="http://power.ti.com">power.ti.com</a>                     | Optical Networking  | <a href="http://www.ti.com/opticalnetwork">www.ti.com/opticalnetwork</a> |
| Microcontrollers | <a href="http://microcontroller.ti.com">microcontroller.ti.com</a> | Security            | <a href="http://www.ti.com/security">www.ti.com/security</a>             |
|                  |  | Telephony           | <a href="http://www.ti.com/telephony">www.ti.com/telephony</a>           |
|                  |  | Video & Imaging     | <a href="http://www.ti.com/video">www.ti.com/video</a>                   |
|                  |  | Wireless            | <a href="http://www.ti.com/wireless">www.ti.com/wireless</a>             |

Mailing Address: Texas Instruments  
Post Office Box 655303 Dallas, Texas 75265