



PTB 20170 30 Watts, 1.8–2.0 GHz Cellular Radio RF Power Transistor

Description

The 20170 is a class AB, NPN, common emitter RF power transistor intended for 26 Vdc operation from 1.8 to 2.0 GHz. Rated at 30 watts minimum output power, it may be used for both CW and PEP applications. Ion implantation, nitride surface passivation and gold metallization are used to ensure excellent device reliability. 100% lot traceability is standard.

- 30 Watts, 1.8–2.0 GHz
- Class AB Characteristics
- Gold Metallization
- Silicon Nitride Passivated

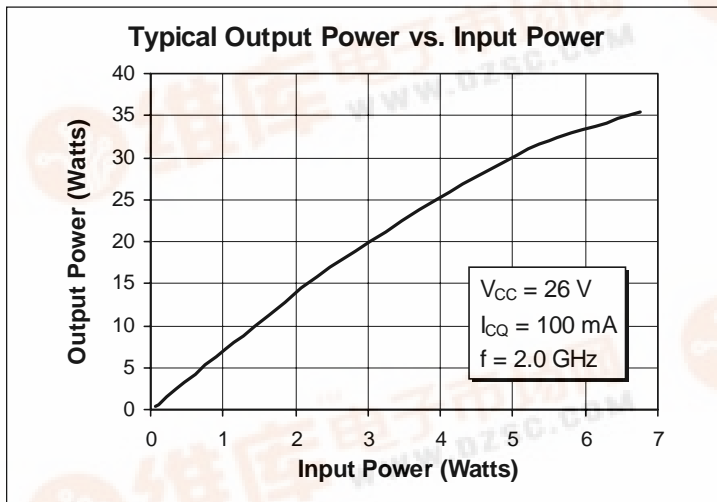

Maximum Ratings

Parameter	Symbol	Value	Unit
Collector-Emitter Voltage	V_{CER}	55	Vdc
Collector-Emitter Voltage	V_{CES}	55	Vdc
Emitter-Base Voltage (collector open)	V_{EBO}	4.0	Vdc
Collector Current (continuous)	I_C	6.7	Adc
Total Device Dissipation at $T_{flange} = 25^{\circ}C$ Above $25^{\circ}C$ derate by	P_D	123 0.7	Watts $W/^{\circ}C$
Storage Temperature Range	T_{STG}	-40 to +150	$^{\circ}C$
Thermal Resistance ($T_{flange} = 70^{\circ}C$)	$R_{\theta JC}$	1.43	$^{\circ}C/W$



Electrical Characteristics (100% Tested)

Characteristic	Conditions	Symbol	Min	Typ	Max	Units
Breakdown Voltage C to E	$I_C = 50 \text{ mA}$, $R_{BE} = 27 \Omega$	$V_{(BR)CER}$	55	—	—	Volts
Breakdown Voltage C to E	$V_{BE} = 0 \text{ V}$, $I_C = 50 \text{ mA}$	$V_{(BR)CES}$	55	—	—	Volts
Breakdown Voltage E to B	$I_C = 0 \text{ A}$, $I_E = 5 \text{ mA}$	$V_{(BR)EBO}$	4	5	—	Volts
DC Current Gain	$V_{CE} = 5 \text{ V}$, $I_C = 250 \text{ mA}$	h_{FE}	20	50	120	—

RF Specifications (100% Tested)

Characteristic	Symbol	Min	Typ	Max	Units
Gain ($V_{CC} = 26 \text{ Vdc}$, $P_{Out} = 30 \text{ W}$, $I_{CQ} = 100 \text{ mA}$, $f = 2.0 \text{ GHz}$)	G_{pe}	7.0	8.5	—	dB
Collector Efficiency ($V_{CC} = 26 \text{ Vdc}$, $P_{Out} = 30 \text{ W}$, $I_{CQ} = 100 \text{ mA}$, $f = 2.0 \text{ GHz}$)	η_C	38	46	—	%
Load Mismatch Tolerance ($V_{CC} = 26 \text{ Vdc}$, $P_{Out} = 30 \text{ W(PEP)}$, $I_{CQ} = 100 \text{ mA}$, $f = 2.0 \text{ GHz}$ —all phase angles at frequency of test)	Ψ	—	—	5:1	—

Typical Performance

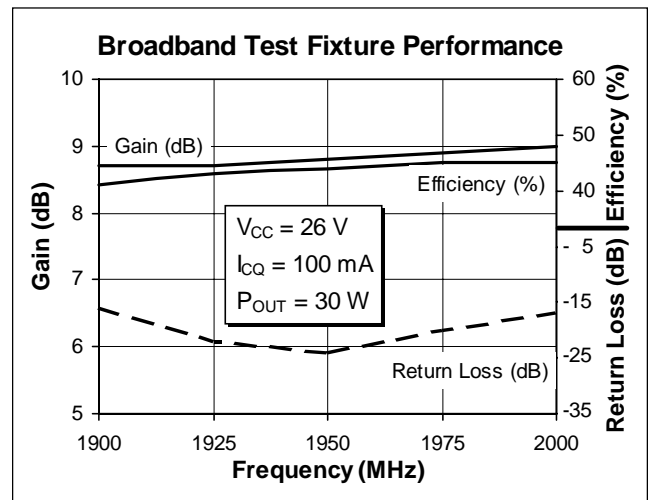
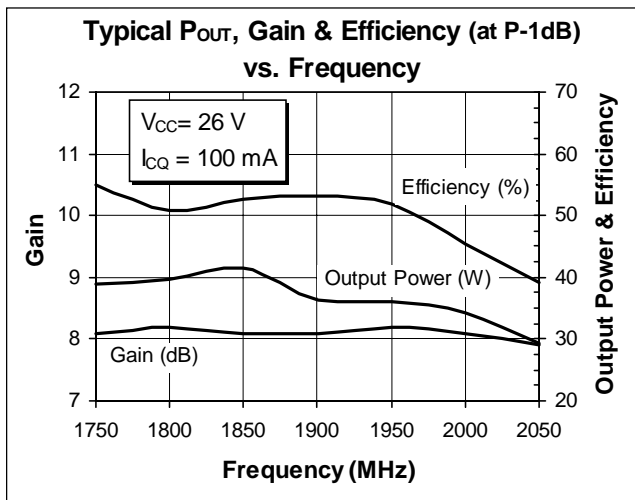

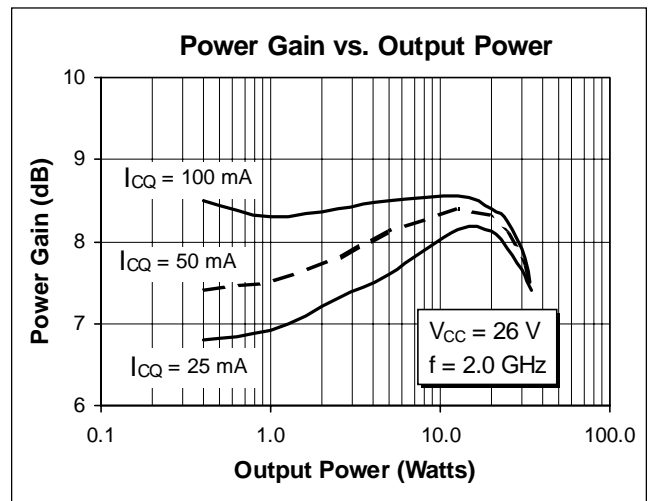
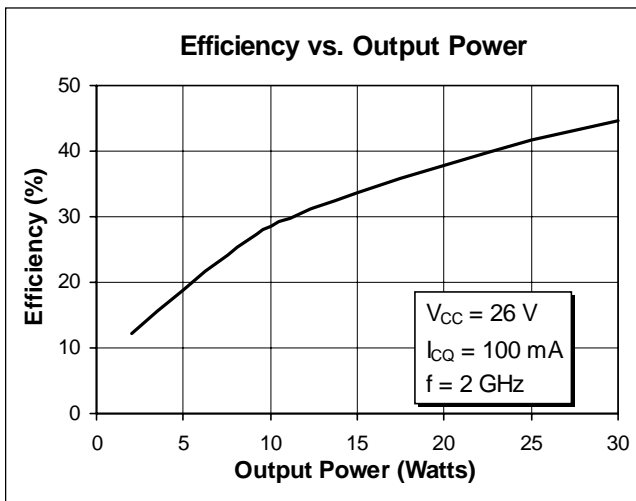
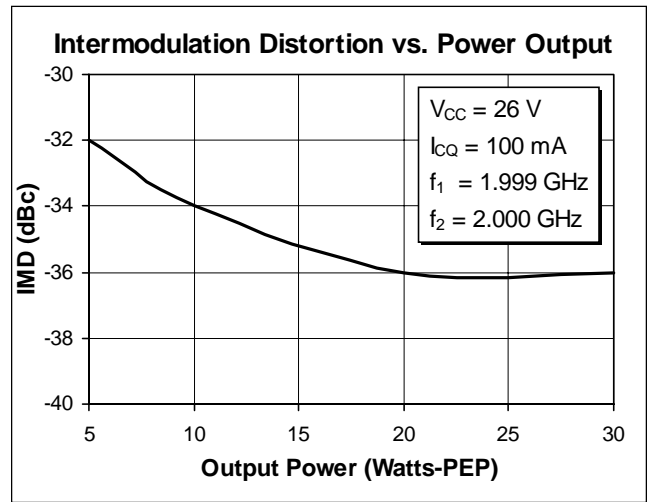
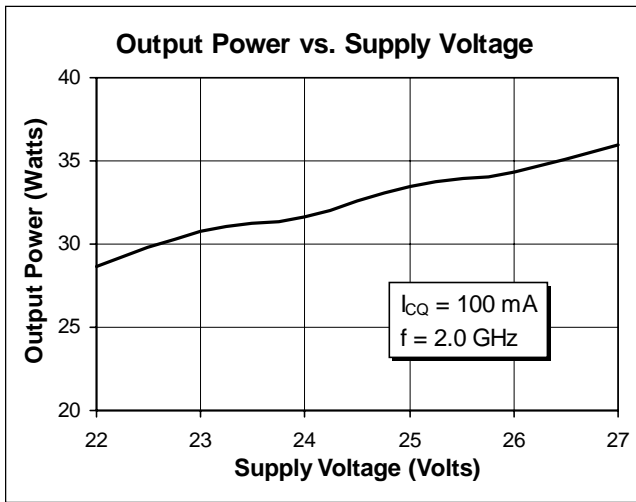

Impedance Data

($V_{CC} = 26 \text{ Vdc}$, $P_{out} = 30 \text{ W}$, $I_{CQ} = 100 \text{ mA}$)

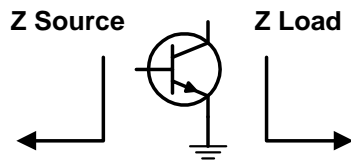

Frequency GHz	Z Source		Z Load	
	R	jX	R	jX
1.75	2.9	-6.3	2.60	-0.7
1.80	3.1	-6.6	2.40	-1.2
1.85	3.9	-7.1	2.20	-1.5
1.90	6.4	-7.8	2.00	-1.8
1.95	7.7	-6.3	1.80	-2.2
2.00	8.6	-5.6	1.85	-2.7
2.05	7.3	-2.7	1.92	-3.2

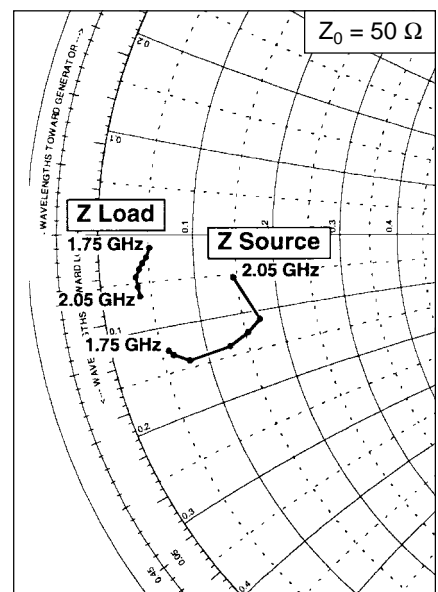

Test Circuit

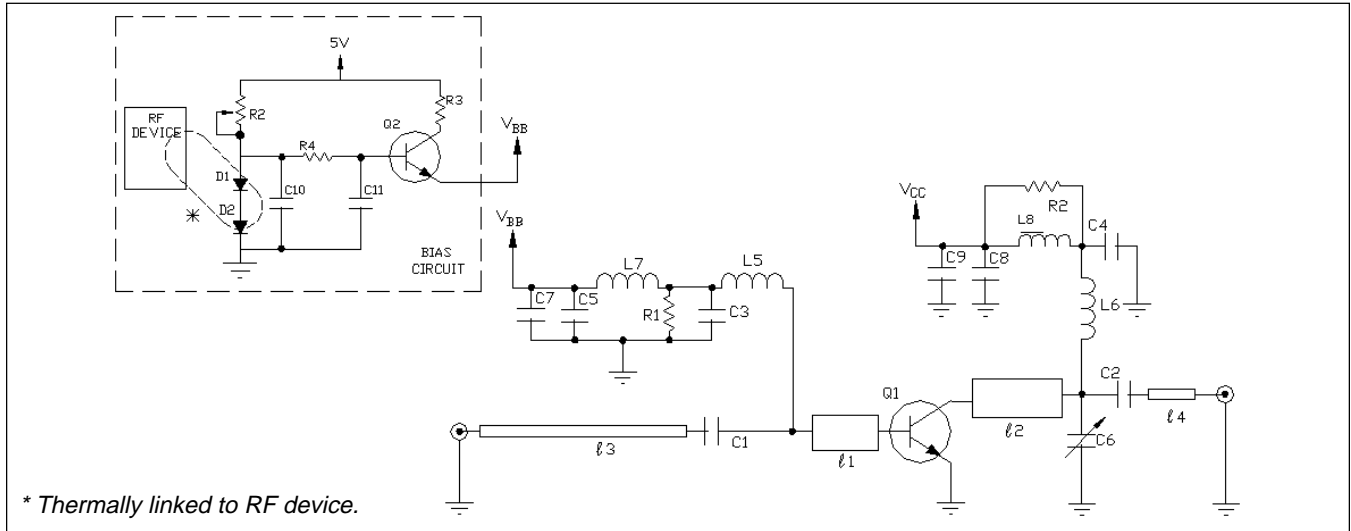

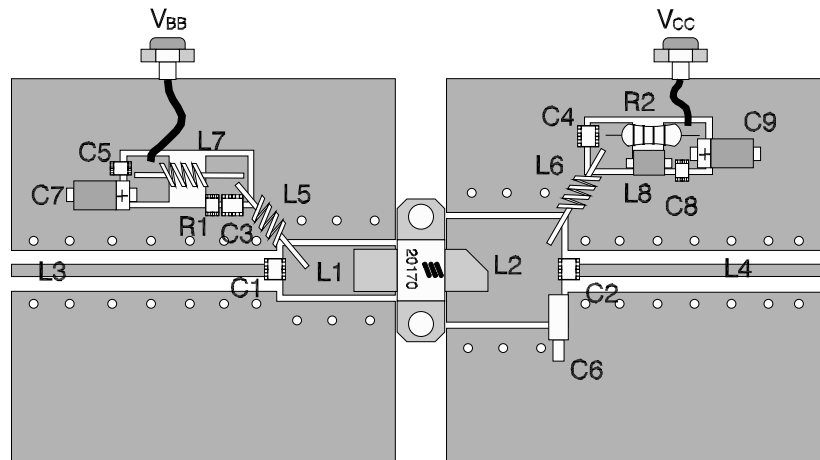

Schematic for $f = 2 \text{ GHz}$

Q1	20170, NPN RF Transistor	R1	22 Ω 118 W SMT Resistor
L1	.185 λ 2GHz, Microstrip 18 Ω	R2	12 Ω .5 W Axial Resistor
L1	.195 λ 2GHz, Microstrip 9.5 Ω	Circuit Board	.031 G-200, Solid Copper Bottom AlliedSignal
L5, L6	4 Turn #20 AWG, .120" I.D.	<i>Bias Parts (not shown on layout)</i>	
L7	56 μA SMT Inductor	Q2	BCP 56 SMT NPN Transistor
L8	Ferrite Bead	D1	BAV 99 Diode
C1, C2,	33 pF ATC-B	C10, C11	0.1 pF SMT Capacitor
C3, C4	33 pF ATC-B	R2	2K Potentiometer
C5, C7	0.1 μF , 1206	R3, R4	10 Ω 1206 SMT Resistor
C6, C8	10 pF SMT Electrolytic Capacitor		
C9	0-4 pF Johanson Variable Capacitor		

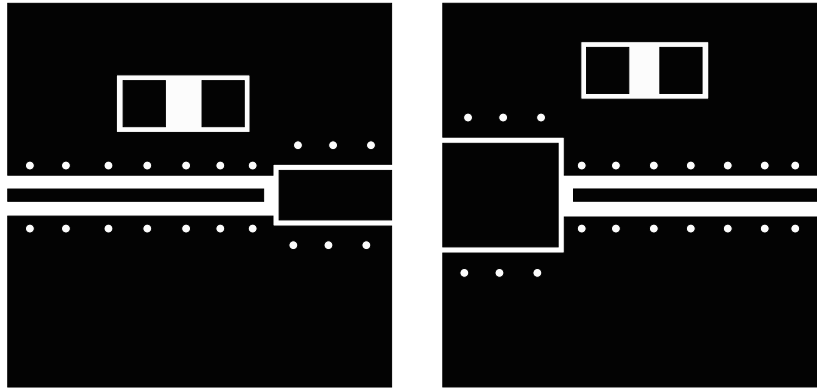

Board Assembly (not to scale)



Artwork (1 inch )