



PTF 10100

165 Watts, 860–900 MHz

LDMOS Field Effect Transistor

Description

The 10100 is an internally matched common source N-channel enhancement-mode lateral MOSFET intended for large signal amplifier applications from 860 to 900 MHz. It is rated at 165 watts power output. Nitride surface passivation and gold metallization ensure excellent device lifetime and reliability.

- **INTERNALLY MATCHED**
- Performance at 894 MHz, 28 Volts
 - Output Power = 165 Watts
 - Power Gain = 13.0 dB Typ
 - Drain Efficiency = 50% Typ
- Full Gold Metallization
- Silicon Nitride Passivated
- Back Side Common Source
- 100% lot traceability

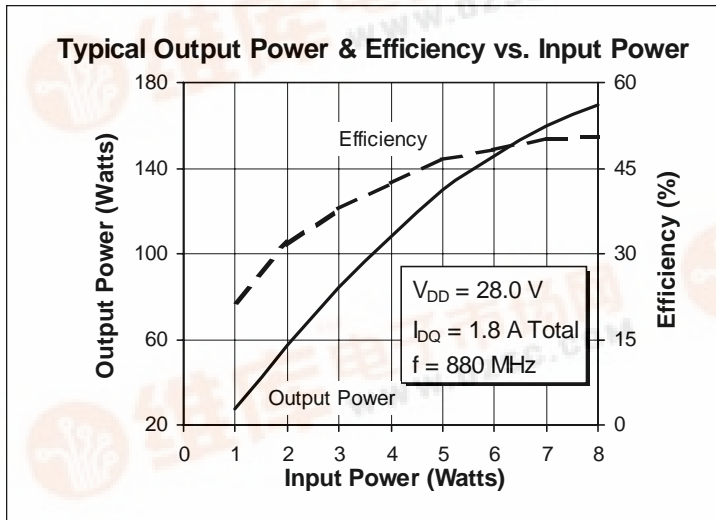

Maximum Ratings

Parameter	Symbol	Value	Unit
Drain-Source Voltage ⁽¹⁾	V _{DSS}	65	Vdc
Gate-Source Voltage ⁽¹⁾	V _{GS}	±20	Vdc
Operating Junction Temperature	T _J	200	°C
Total Device Dissipation at T _f lange = 25°C Above 25°C derate by	P _D	500 2.85	Watts W/°C
Storage Temperature Range	T _{STG}	-40 to +150	°C
Thermal Resistance (T _f lange = 70°C)	R _{θJC}	0.35	°C/W



Electrical Characteristics (per side) (100% Tested)

Characteristic	Conditions	Symbol	Min	Typ	Max	Units
Drain-Source Breakdown Voltage	$V_{GS} = 0\text{ V}, I_D = 5\text{ mA}$	$V_{(BR)DSS}$	65	—	—	Volts
Drain-Source Leakage Current	$V_{DS} = 28\text{ V}, V_{GS} = 0\text{ V}$	I_{DSS}	—	—	1.0	mA
Gate Threshold Voltage	$V_{DS} = 10\text{ V}, I_D = 75\text{ mA}$	$V_{GS(th)}$	—	4.3	—	Volts
Forward Transconductance	$V_{DS} = 10\text{ V}, I_D = 3\text{ A}$	g_{fs}	—	2.5	—	Siemens

RF Specifications (100% Tested)

Characteristic	Symbol	Min	Typ	Max	Units
Gain ($V_{DD} = 28\text{ V}, P_{OUT} = 165\text{ W}, I_{DQ} = 1.8\text{ A Total}, f = 894\text{ MHz}$)	G_{ps}	12.0	13.0	—	dB
Power Output at 1 dB Compression ($V_{DD} = 28\text{ V}, I_{CQ} = 1.8\text{ A Total}, f = 880\text{ MHz}$)	P-1dB	165	180	—	Watts
Drain Efficiency ($V_{DD} = 28\text{ V}, P_{OUT} = 165\text{ W}, I_{DQ} = 1.8\text{ A Total}, f = 894\text{ MHz}$)	η	45	50	—	%
Load Mismatch Tolerance ($V_{DD} = 28\text{ V}, P_{OUT} = 165\text{ W(PEP)}, I_{DQ} = 1.8\text{ A Total}, f = 893.9, 894\text{ MHz}$ —all phase angles at frequency of test)	Ψ	—	—	10:1	—

Typical Performance

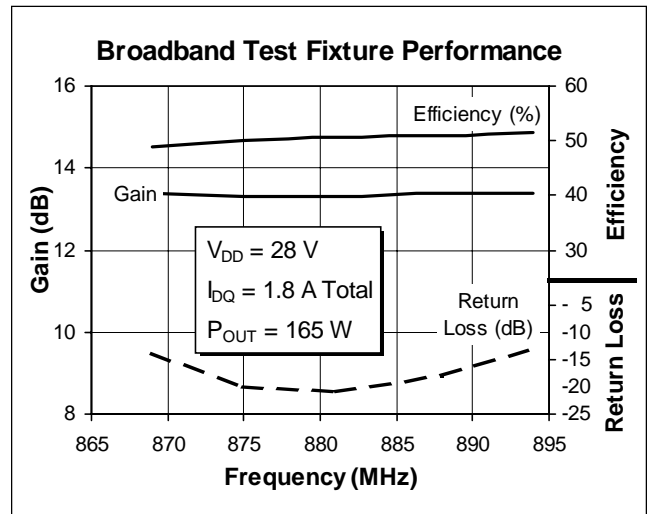
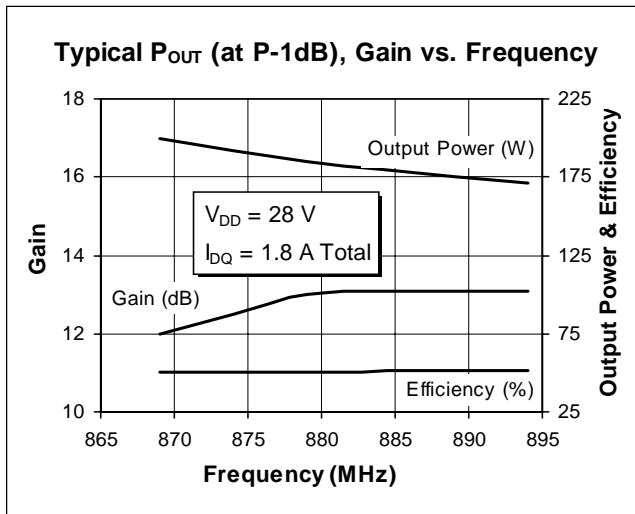

Typical Performance

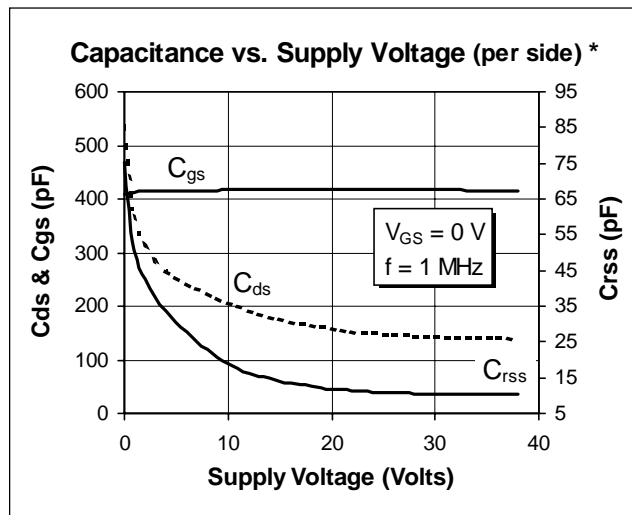
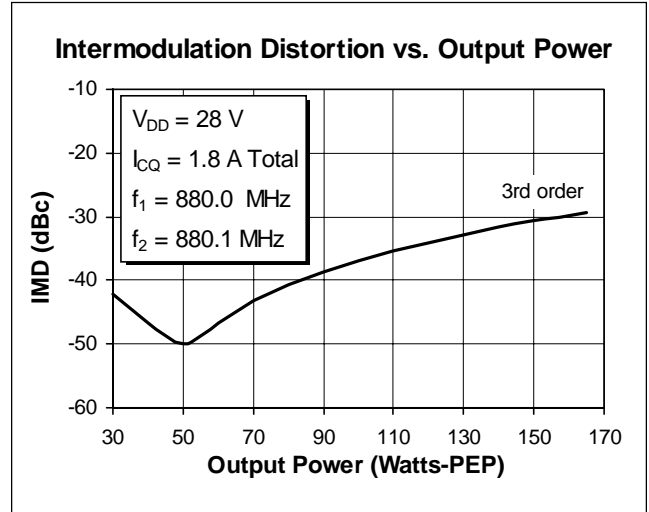
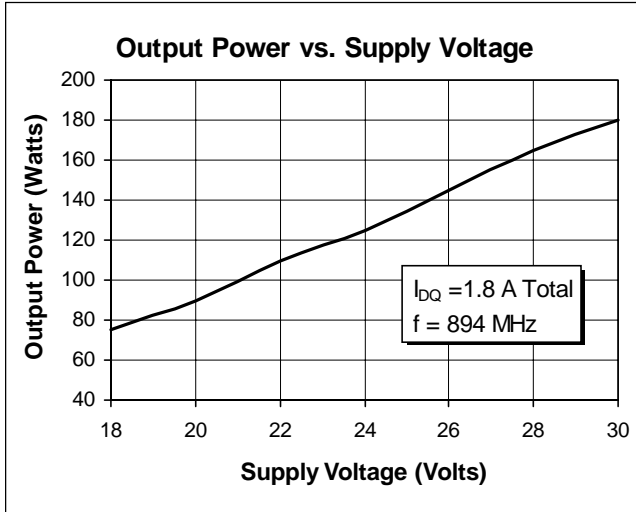

*This part is internally matched. Measurements of the finished product will not yield these figures.

PTF 10100



Impedance Data

$V_{DD} = 28 \text{ V}$, $I_{DQ} = 1.8 \text{ A Total}$, $P_{OUT} = 165 \text{ W}$

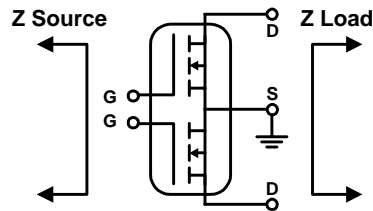

Frequency MHz	Z Source Ω		Z Load Ω	
	R	jX	R	jX
860	2.3	1.6	1.60	-1.1
870	1.9	0.8	1.70	-1.7
880	1.8	0.3	1.90	-2.1
890	1.7	0.1	1.95	-1.8
900	1.6	-0.2	1.80	-1.5

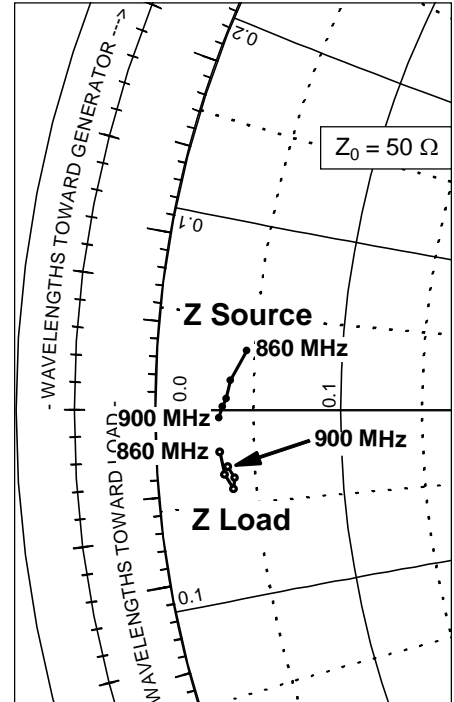

Typical Scattering Parameters

($V_{DS} = 28 \text{ V}$, $I_D = 2 \text{ A per side}$)

f (MHz)	S11		S21		S12		S22	
	Mag	Ang	Mag	Ang	Mag	Ang	Mag	Ang
300	0.980	-178	0.996	15.6	0.010	-85.2	0.994	-177
350	0.982	-179	0.773	12.8	0.008	-85.3	0.993	-177
400	0.983	-180	0.641	9.48	0.006	-85.7	0.992	-178
450	0.989	179	0.545	7.19	0.005	-85.3	0.996	-179
500	0.989	179	0.489	5.48	0.003	-93.7	0.999	-179
550	0.987	179	0.449	2.11	0.002	-74.5	0.995	-179
600	0.983	178	0.425	-0.90	0.002	-64.9	0.996	-179
650	0.982	177	0.414	-4.52	0.001	-68.5	0.998	-180
700	0.980	176	0.405	-10.2	0.001	-55.1	0.997	-180
750	0.972	175	0.419	-14.3	0.001	-88.5	0.997	180
800	0.958	174	0.442	-19.9	0.001	-87.2	0.993	180
850	0.929	171	0.509	-27.5	0.005	-105	0.991	179
900	0.858	168	0.662	-42.4	0.013	-133	0.989	179
950	0.693	173	0.882	-75.9	0.030	174	0.987	179
1000	0.783	-170	0.714	-125	0.028	120	0.993	179
1050	0.918	-172	0.423	-153	0.022	101	0.989	179
1100	0.951	-175	0.261	-167	0.020	89.2	0.982	179
1150	0.974	-177	0.184	-179	0.019	81.8	0.982	178
1200	0.988	-178	0.124	165	0.018	77.9	0.990	178
1250	0.984	-179	0.060	158	0.017	76.7	0.990	178
1300	0.979	-180	0.048	-154	0.018	77.4	0.986	178
1350	0.980	180	0.070	179	0.018	73.9	0.983	178
1400	0.992	180	0.058	166	0.018	74.5	0.990	177
1450	0.991	179	0.049	156	0.019	78.7	0.992	178
1500	0.986	178	0.042	149	0.021	79.7	0.984	178

Test Circuit

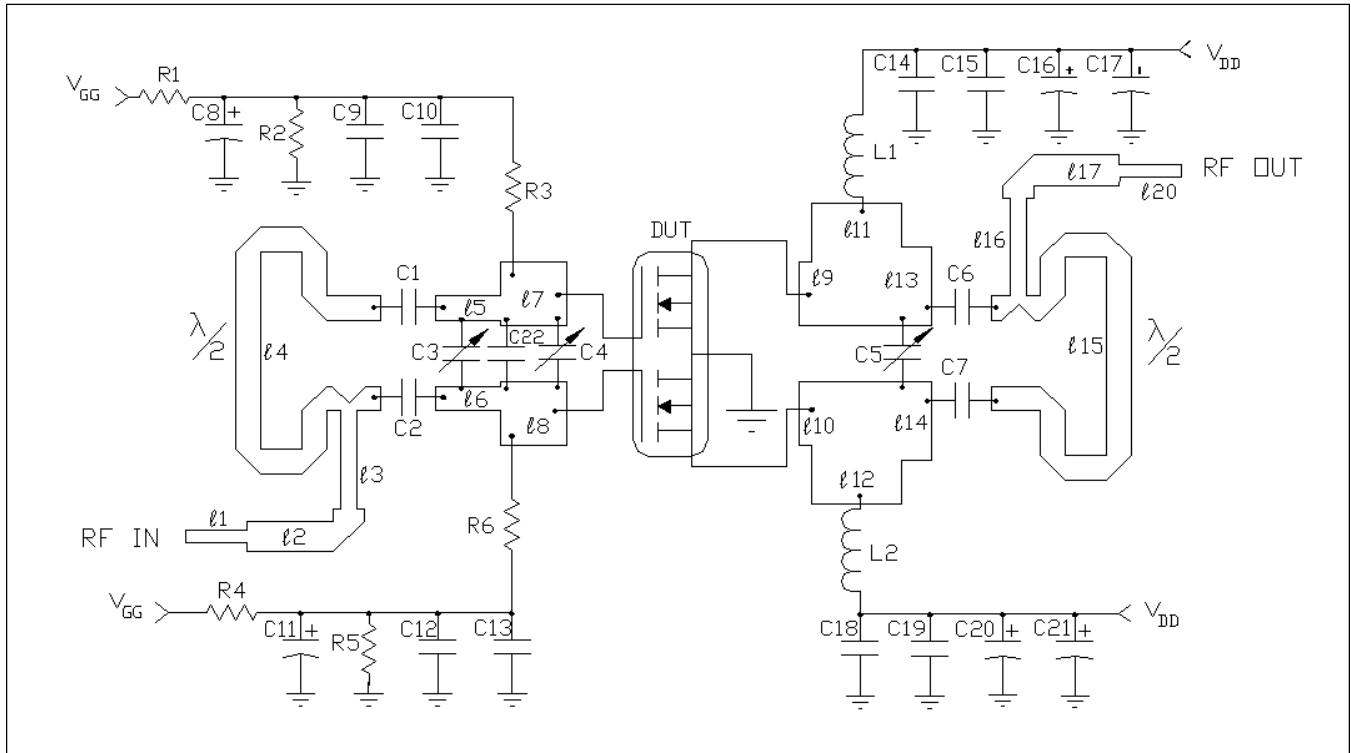

Schematic for $f = 894 \text{ MHz}$

DUT	10100
C1-2	15 pF, Capacitor ATC 100 B
C3	0.6–6.0 pF, Variable Capacitor
C4	0.35–3.5 pF, Variable Capacitor
C5	1–9 pF, Variable Capacitor
C6-7, C10, C13-14, C18	33 pF, Capacitor ATC 100 B
C8, C11	10 μF , +10 V Tantalum
C9, C12, C15, C19	0.01 μF , Capacitor ATC 100 B
C16, C17, C20, C21	10 μF , +30 V Tantalum
C22	11 pF, Capacitor ATC 100 B
L1, L2	4 Turn, #20 AWG, .120" I.D.
R1, R2, R4, R5	510 Ω Resistor
R3, R6	510 Ω Resistor

l1, l20	50 Ω , .030 λ
l2, l17	20 Ω , .089 λ
l3, l16	9.6 Ω , .055 λ
l4, l15	25 Ω , .500 λ
l5, l6	25 Ω , .373 λ
l7, l8	12.2 Ω , .062 λ
l9, l10	13.0 Ω , .017 λ
l11, l12	6.6 Ω , .059 λ
l13, l14	9.6 Ω , .055 λ
Circuit Board	.028" G200, $\epsilon_r = 4.55$ @ 1 MHz, AlliedSignal

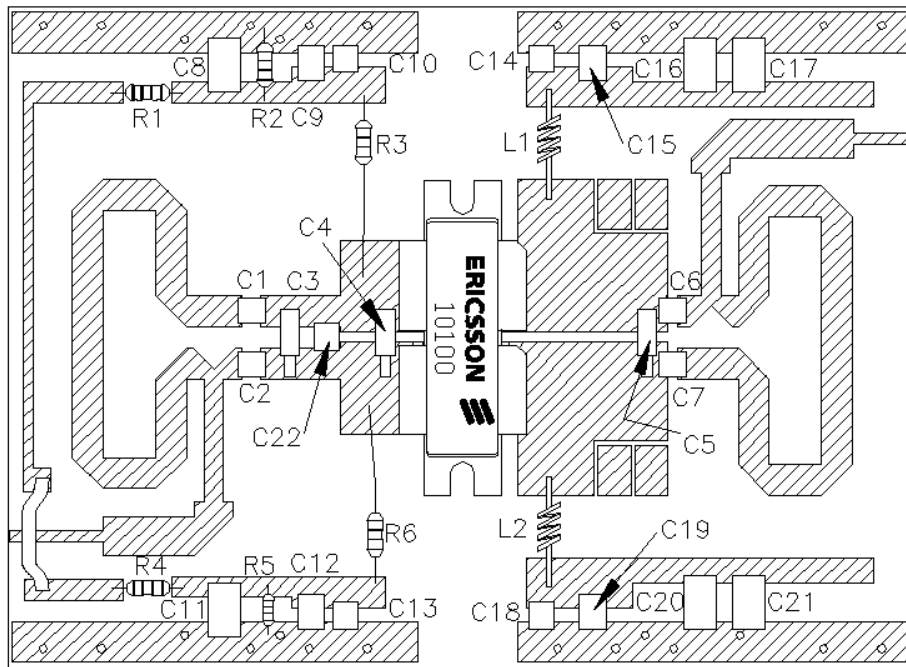

Components Layout (not to scale)

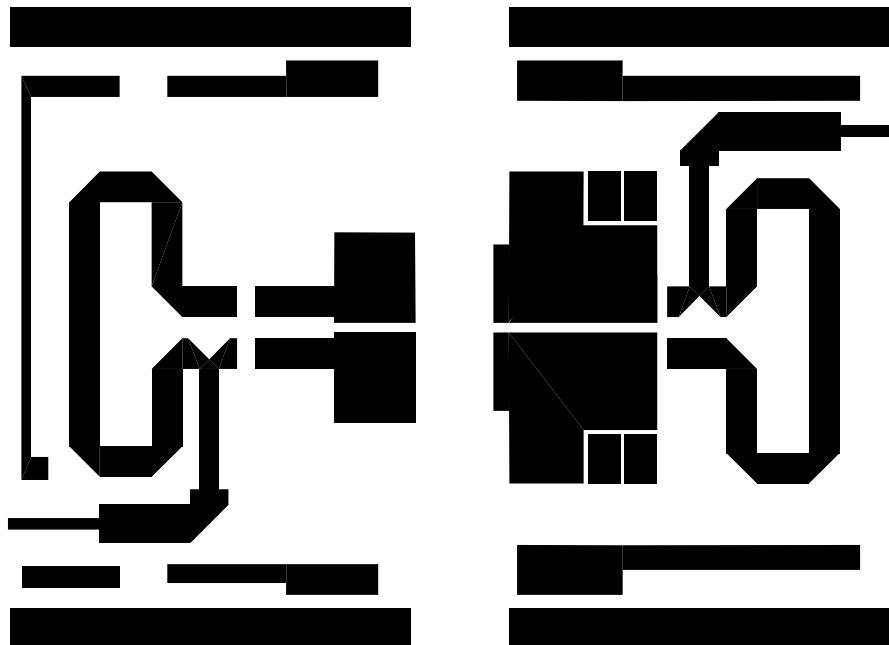

Artwork (1 inch )