

PTF 102028

18 Watts, 860–960 MHz

GOLDMOS® Field Effect Transistor

Description

The PTF 102028 is an 18-watt GOLDMOS FET intended for large signal amplifier applications 860 to 960 MHz. It operates with 55% efficiency and 15 dB gain. Nitride surface passivation and full gold metallization ensure excellent device lifetime and reliability.

- **Performance at 960 MHz, 26 Volts**
 - Output Power = 18 Watts Min
 - Power Gain = 15 dB Typ
 - Efficiency = 55% Typ
- Full Gold Metallization
- Silicon Nitride Passivated
- Excellent Thermal Stability
- Back Side Common Source
- 100% Lot Traceability

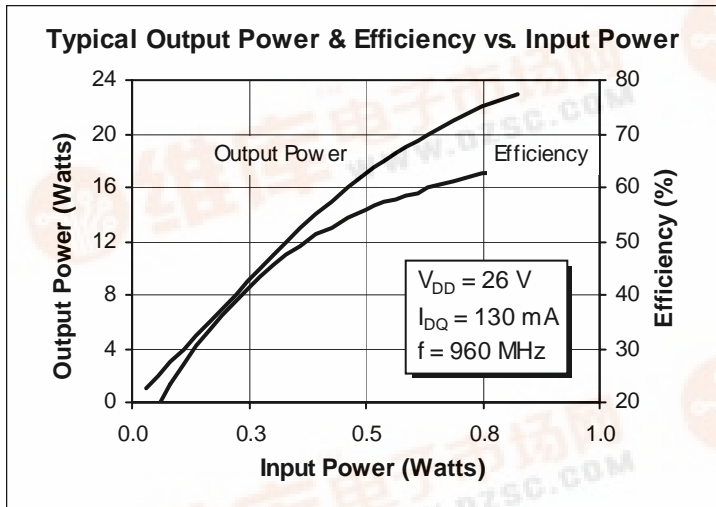

Package 20251

RF Specifications (100% Tested)

Characteristic	Symbol	Min	Typ	Max	Units
Common Source Power Gain ($V_{DD} = 26\text{ V}$, $P_{OUT} = 18\text{ W}$, $I_{DQ} = 130\text{ mA}$, $f = 960\text{ MHz}$)	G_{ps}	14	15	—	dB
Power Output at 1 dB Compression ($V_{DD} = 26\text{ V}$, $I_{DQ} = 130\text{ mA}$, $f = 960\text{ MHz}$)	P-1dB	18	20	—	Watts
Drain Efficiency ($V_{DD} = 26\text{ V}$, $P_{OUT} = 18\text{ W}$, $I_{DQ} = 130\text{ mA}$, $f = 960\text{ MHz}$)	η	50	55	—	%
Load Mismatch Tolerance ($V_{DD} = 26\text{ V}$, $P_{OUT} = 18\text{ W}$, $I_{DQ} = 130\text{ mA}$, $f = 960\text{ MHz}$ — all phase angles at frequency of test)	Ψ	—	—	5:1	—

All published data at $T_{CASE} = 25^\circ\text{C}$ unless otherwise indicated.

Electrical Characteristics (100% Tested)

Characteristic	Conditions	Symbol	Min	Typ	Max	Units
Drain-Source Breakdown Voltage	$V_{GS} = 0\text{ V}, I_D = 25\text{ mA}$	$V_{(BR)DSS}$	65	—	—	Volts
Drain-Source Leakage Current	$V_{DS} = 28\text{ V}, V_{GS} = 0\text{ V}$	I_{DSS}	—	—	1.0	mA
Gate Threshold Voltage	$V_{DS} = 10\text{ V}, I_D = 75\text{ mA}$	$V_{GS(th)}$	3.0	—	5.0	Volts
Forward Transconductance	$V_{DS} = 10\text{ V}, I_D = 0.5\text{ A}$	g_{fs}	—	0.9	—	Siemens

Maximum Ratings

Parameter	Symbol	Value	Unit
Drain-Source Voltage	V_{DSS}	65	Vdc
Gate-Source Voltage	V_{GS}	± 20	Vdc
Operating Junction Temperature	T_J	200	$^{\circ}\text{C}$
Total Device Dissipation Above 25 $^{\circ}\text{C}$ derate by	P_D	58 0.33	Watts W/ $^{\circ}\text{C}$
Storage Temperature	T_{STG}	150	$^{\circ}\text{C}$
Thermal Resistance ($T_{CASE} = 70^{\circ}\text{C}$)	$R_{\theta JC}$	3.0	$^{\circ}\text{C}/\text{W}$

Typical Performance

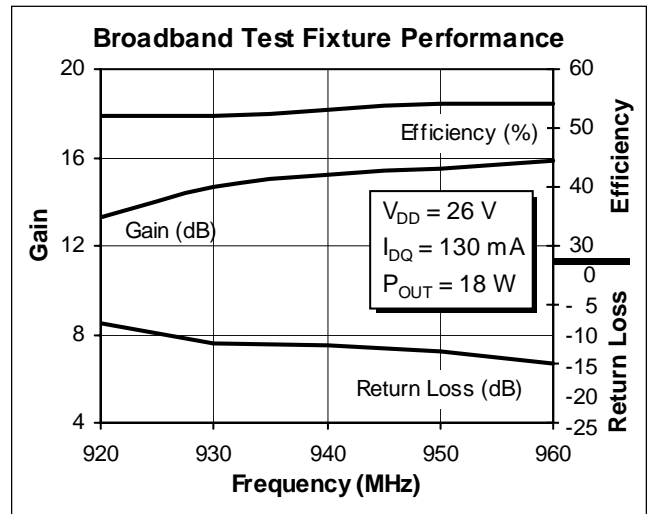
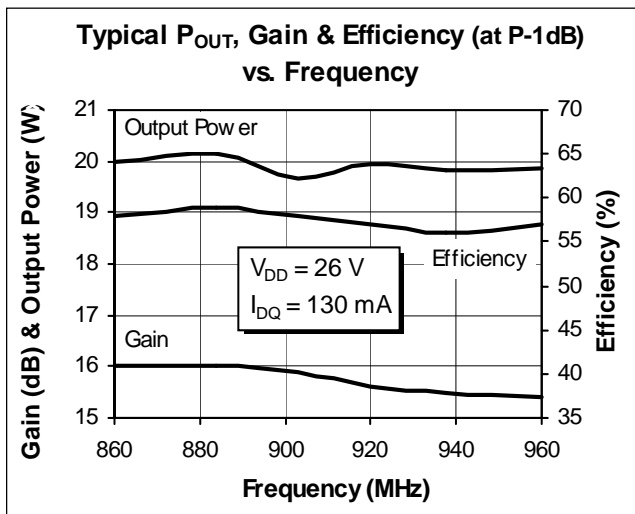

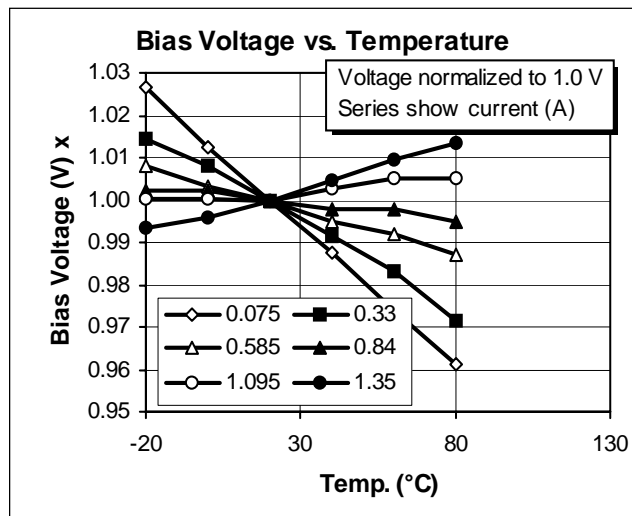
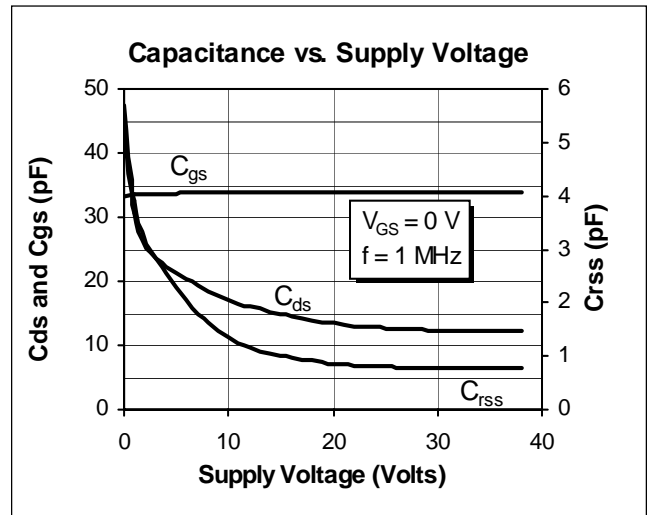
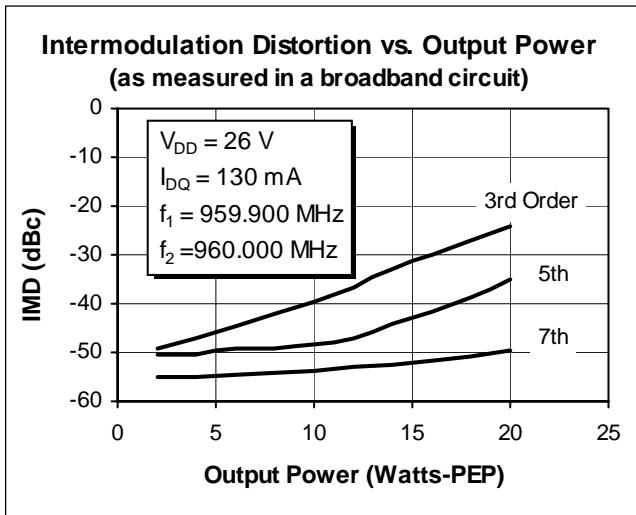
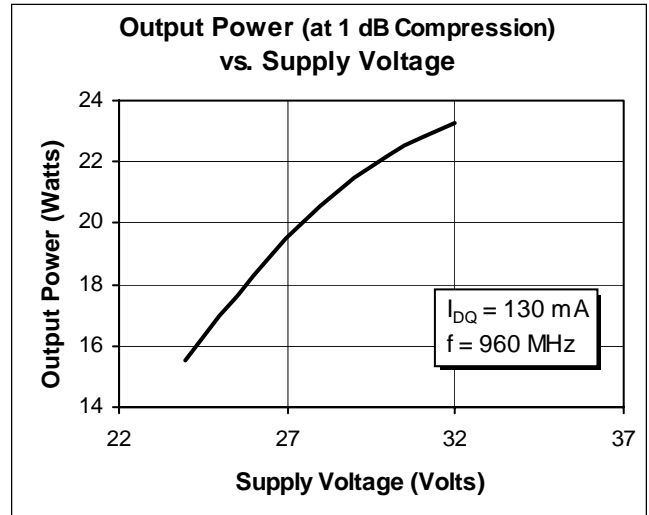
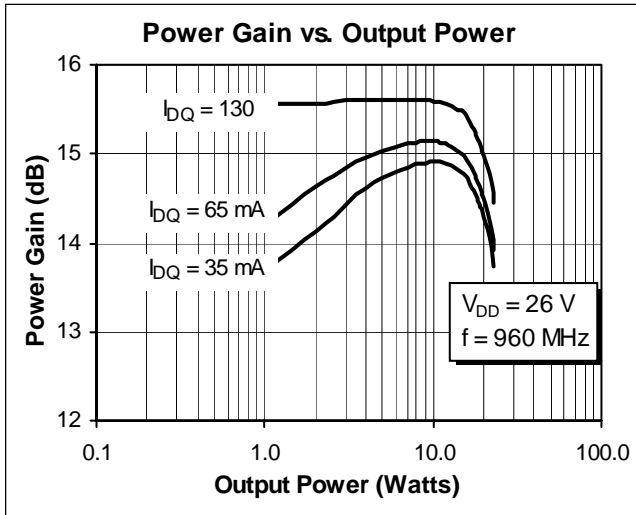

PTF 102028



Impedance Data

$V_{DD} = 26\text{ V}$, $P_{OUT} = 18\text{ W}$, $I_{DQ} = 130\text{ mA}$

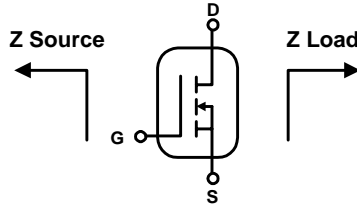

Frequency MHz	Z Source Ω		Z Load Ω	
	R	jX	R	jX
860	2.0	2.7	5.8	4.4
880	2.0	2.6	5.5	4.6
900	2.0	2.4	5.0	5.0
920	1.9	2.3	4.8	5.1
960	1.9	2.1	4.7	5.3

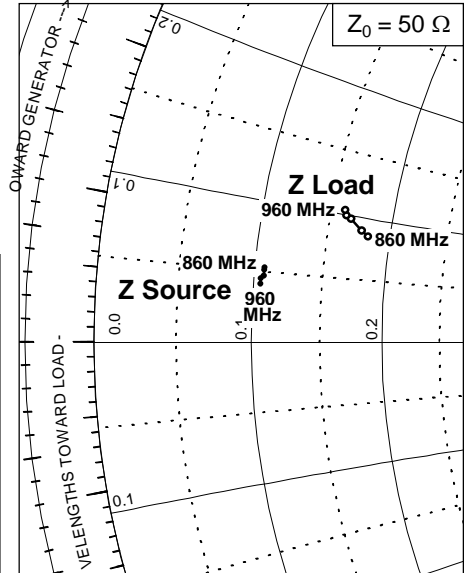

Typical Scattering Parameters
(V_{DS} = 26 V, I_D = 500 mA)

f (MHz)	S11		S21		S12		S22	
	Mag	Ang	Mag	Ang	Mag	Ang	Mag	Ang
100	0.828	-120	27.9	103	0.015	20.6	0.597	-65.9
150	0.821	-138	19.2	87.8	0.014	10.7	0.576	-79.6
200	0.817	-148	14.1	77.5	0.013	6.0	0.571	-91.7
250	0.825	-155	10.8	69.6	0.011	6.5	0.602	-102
300	0.836	-160	8.75	62.7	0.009	9.7	0.628	-110
350	0.847	-164	7.09	56.4	0.007	20.7	0.661	-118
400	0.859	-167	5.96	51.3	0.006	41.5	0.698	-124
450	0.870	-170	5.02	45.6	0.007	64.2	0.723	-130
500	0.883	-172	4.31	42.2	0.008	83.2	0.754	-135
550	0.892	-174	3.71	36.9	0.011	92.6	0.783	-140
600	0.902	-176	3.20	33.3	0.014	97.9	0.805	-144
650	0.909	-179	2.81	29.6	0.016	98.5	0.831	-149
700	0.919	180	2.48	26.7	0.020	98.6	0.845	-152
750	0.922	178	2.19	23.6	0.022	98.7	0.860	-155
800	0.930	176	1.97	21.1	0.025	99.3	0.880	-158
850	0.934	174	1.77	17.5	0.028	98.6	0.890	-161
900	0.941	173	1.61	16.3	0.032	98.3	0.904	-164
950	0.943	171	1.47	12.5	0.035	95.8	0.916	-166
1000	0.944	170	1.31	10.8	0.039	95.4	0.922	-168
1050	0.946	169	1.21	8.51	0.043	92.5	0.930	-171
1100	0.950	167	1.12	5.94	0.046	91.7	0.937	-172
1150	0.950	166	1.02	3.97	0.049	91.4	0.945	-174
1200	0.952	164	0.952	4.03	0.053	90.5	0.945	-176
1250	0.952	163	0.902	0.16	0.057	87.1	0.955	-178
1300	0.952	162	0.805	-0.92	0.060	87.6	0.951	-180
1350	0.953	160	0.781	-1.19	0.065	86.6	0.958	178
1400	0.956	159	0.732	-5.01	0.068	84.9	0.955	177
1450	0.954	157	0.688	-5.67	0.072	84.9	0.963	175
1500	0.952	156	0.660	-6.40	0.078	84.2	0.953	173
1550	0.952	154	0.619	-6.60	0.084	83.9	0.967	172
1600	0.949	153	0.573	-7.30	0.085	83.7	0.950	170
1650	0.948	151	0.591	-7.58	0.097	83.1	0.959	169
1700	0.947	150	0.523	-7.59	0.096	82.2	0.950	167
1750	0.946	148	0.492	-7.59	0.106	81.6	0.949	166
1800	0.945	147	0.498	-7.60	0.113	81.4	0.953	163
1850	0.943	145	0.453	-7.64	0.119	80.9	0.952	163
1900	0.942	143	0.442	-6.40	0.124	79.8	0.947	160
1950	0.945	142	0.433	-6.23	0.134	79.6	0.957	159
2000	0.947	140	0.406	-6.20	0.135	79.5	0.953	157
2050	0.949	139	0.401	-5.74	0.150	80.1	0.946	156
2100	0.951	137	0.392	-5.20	0.154	79.4	0.955	153
2150	0.952	136	0.376	-4.36	0.171	79.0	0.950	153
2200	0.956	134	0.357	-4.30	0.171	76.1	0.949	150

Test Circuit

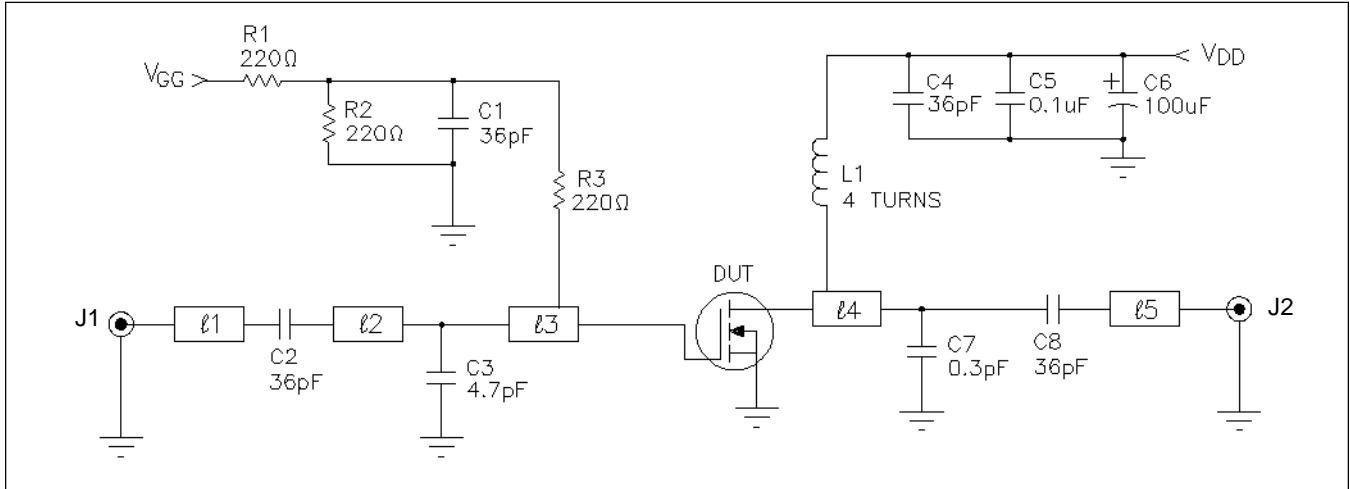

Test Circuit Schematic for $f = 960$ MHz

DUT	PTF 102028	C1, C2, C4, C8	Capacitor, 36 pF	ATC 100 B
l1	0.098λ 960 MHz Microstrip 50 Ω	C3	Capacitor, 4.7 pF	ATC 100 B
l2	0.050λ 960 MHz Microstrip 8.4 Ω	C5	Capacitor, 0.1, μ F, 50 V	Digi-Key P4525-ND
l3	0.139λ 960 MHz Microstrip 8.4 Ω	C6	Capacitor, 100 μ F, 50 V	Digi-Key P5182-ND
l4	0.256λ 960 MHz Microstrip 13.9 Ω	C7	Capacitor, 0.3 pF, 50 V	ATC 100 B
l5	0.040λ 960 MHz Microstrip 50 Ω	J1, J2	Connector, SMA, Female, Panel Mount	Ericsson, # RPM 513 412/53
		L1	4 Turns, 20 AWG, .120 Dia I.D.	N/A
		R1, R2, R3	Resistor, 220 ohm	Digi-Key 2.2 QBK
		Circuit Board	.031 " Thick, $\epsilon_r = 4.0$, AlliedSignal, G200,	2 oz. copper

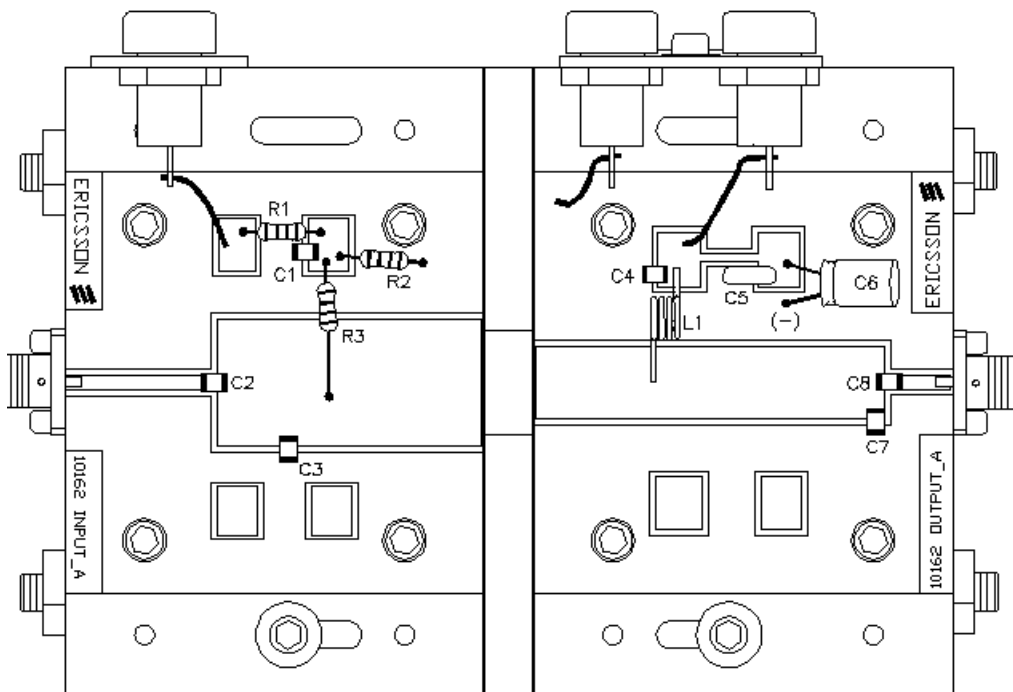

Assembly Diagram (not to scale)

Test Circuit

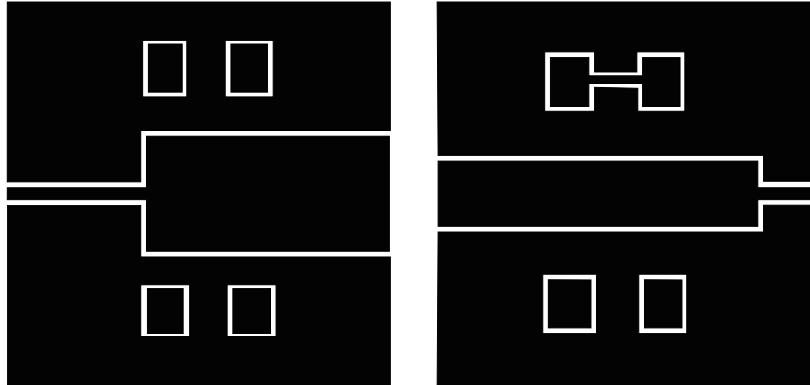

Artwork (not to scale)

Case Outline Specifications

