

IGBT SPseries Six-Pack 50A 1200V

PTMB50B12C

CIRCUIT

OUTLINE DRAWING

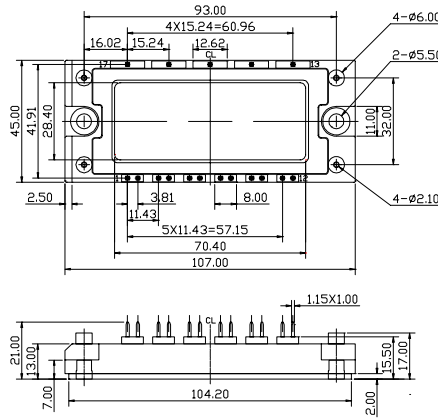
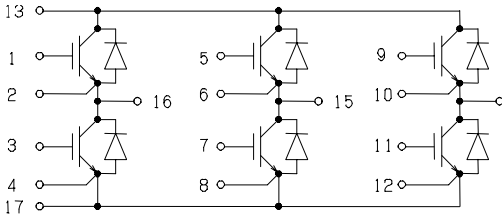

Dimension(mm)

Approximate Weight : 190g

MAXMUM RATINGS (Tc=25°C)

Item	Symbol	PTMB50B12C	Unit
Collector-Emitter Voltage	V _{CES}	1200	V
Gate - Emitter Voltage	V _{GES}	+/- 20	V
Collector Current	DC	I _C	50
	1 ms	I _{CP}	100
Collector Power Dissipation	P _C	250	W
Junction Temperature Range	T _j	-40 to +150	°C
Storage Temperature Range	T _{stg}	-40 to +125	°C
Isolation Voltage Terminal to Base AC, 1 min.)	V _{ISO}	2500	V
Mounting Torque	Module Base to Heatsink	F _{TOR}	2
	Bus Bar to Main Terminals		-

ELECTRICAL CHARACTERISTICS (Tc=25°C)

Characteristic	Symbol	Test Condition	Min.	Typ.	Max.	Unit
Collector-Emitter Cut-Off Current	I _{CES}	V _{CE} =1200V, V _{GE} =0V	-	-	1.0	mA
Gate-Emitter Leakage Current	I _{GES}	V _{GE} =+/- 20V, V _{CE} =0V	-	-	1.0	µA
Collector-Emitter Saturation Voltage	V _{CE(sat)}	I _C =50A, V _{GE} =15V	-	1.9	2.4	V
Gate-Emitter Threshold Voltage	V _{GE(th)}	V _{CE} =5V, I _C =50mA	4.0	-	8.0	V
Input Capacitance	C _{ies}	V _{CE} =10V, V _{GE} =0V, f=1MHz	-	4200	-	pF
Switching Time	Rise Time	V _{CC} = 600V R _L = 12 ohm R _G = 20 ohm V _{GE} = +/- 15V	-	0.25	0.45	µs
	Turn-on Time		-	0.40	0.70	
	Fall Time		-	0.25	0.35	
	Turn-off Time		-	0.80	1.10	

FREE WHEELING DIODES RATINGS & CHARACTERISTICS (Tc=25°C)

Item	Symbol	Rated Value	Unit
Forward Current	DC	I _F	50
	1 ms	I _{FM}	100

Characteristic	Symbol	Test Condition	Min.	Typ.	Max.	Unit
Peak Forward Voltage	V _F	I _F =50A, V _{GE} =0V	-	1.9	2.4	V
Reverse Recovery Time	t _{rr}	I _F =50A, V _{GE} =-10V, di/dt=100A/µs	-	0.2	0.3	µs

THERMAL CHARACTERISTICS

Characteristic	Symbol	Test Condition	Min.	Typ.	Max.	Unit
Thermal Impedance	IGBT	Junction to Case	-	-	0.5	°C/W
	DIODE		-	-	0.1	

PTMB50B12C

Fig.1- Output Characteristics (Typical)

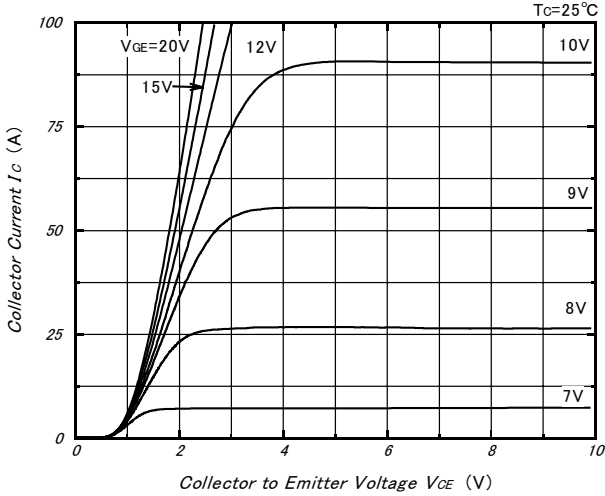

Fig.2- Collector to Emitter On Voltage vs. Gate to Emitter Voltage (Typical)

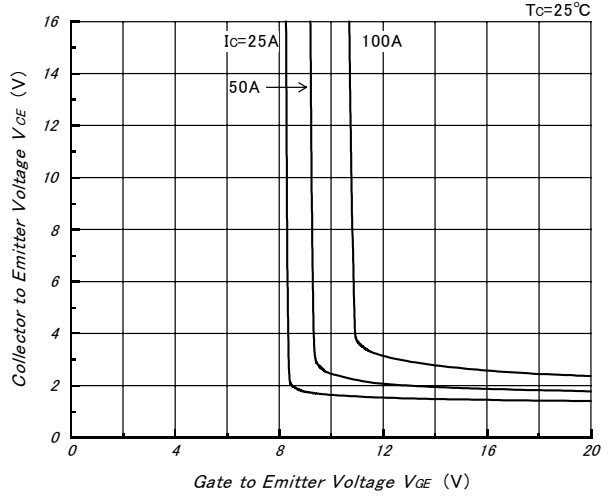

Fig.3- Collector to Emitter On Voltage vs. Gate to Emitter Voltage (Typical)

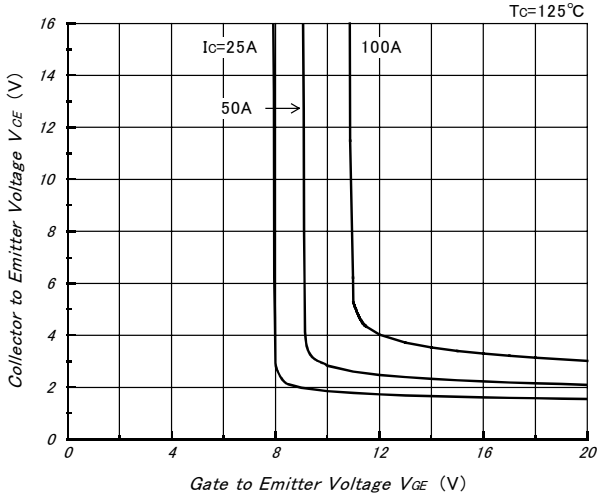

Fig.4- Gate Charge vs. Collector to Emitter Voltage (Typical)

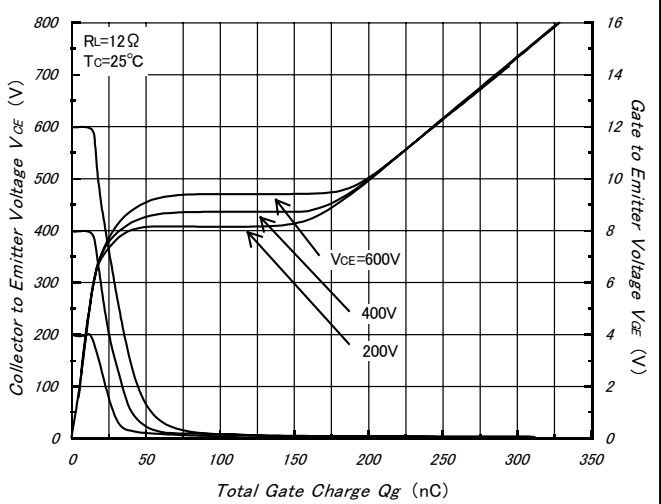

Fig.5- Capacitance vs. Collector to Emitter Voltage (Typical)

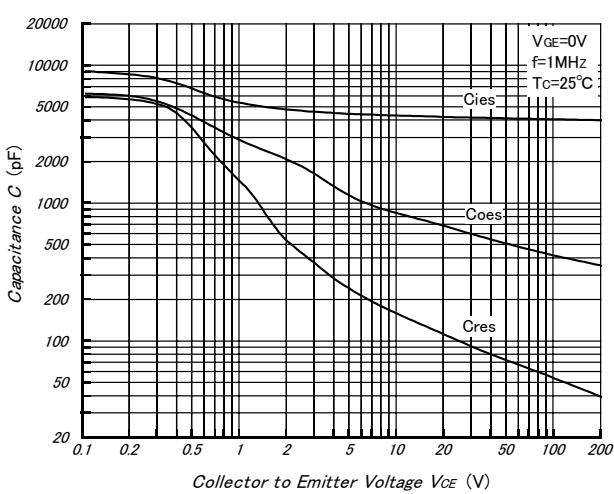
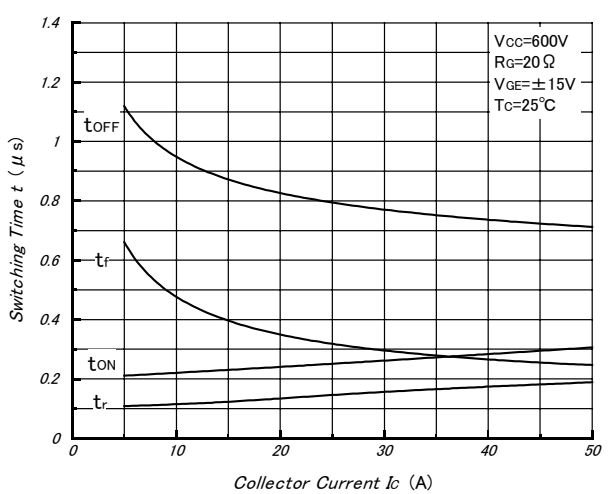

Fig.6- Collector Current vs. Switching Time (Typical)



PTMB50B12C

Fig.7- Series Gate Impedance vs. Switching Time (Typical)

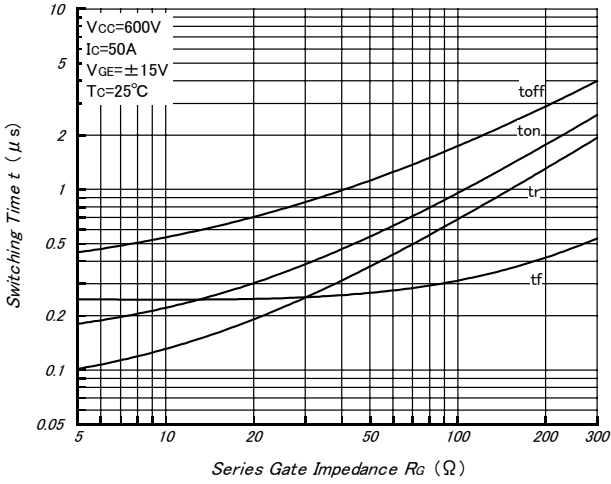

Fig.8- Forward Characteristics of Free Wheeling Diode (Typical)

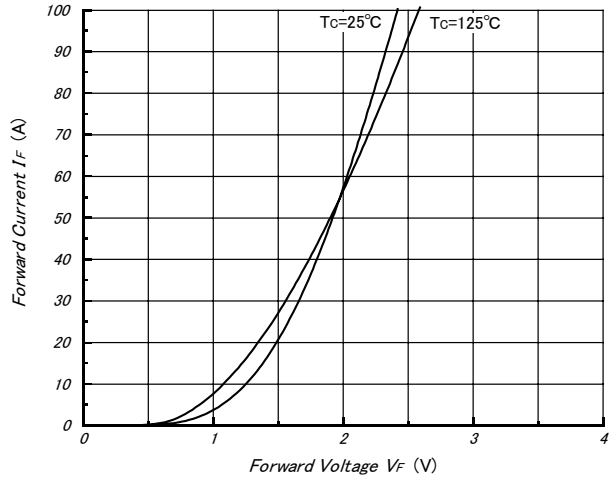

Fig.9- Reverse Recovery Characteristics (Typical)

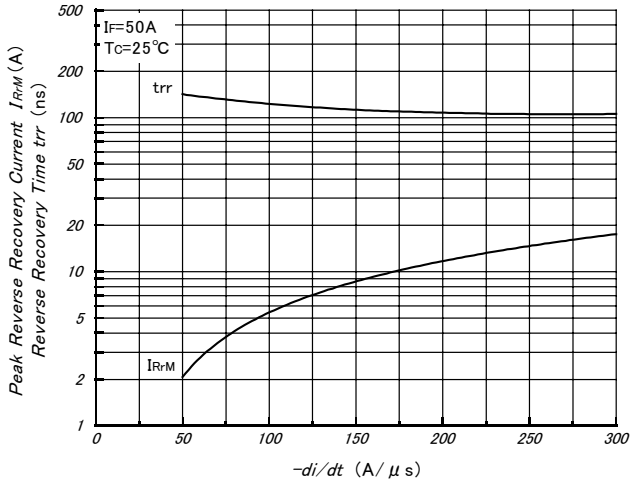

Fig.10- Reverse Bias Safe Operating Area (Typical)

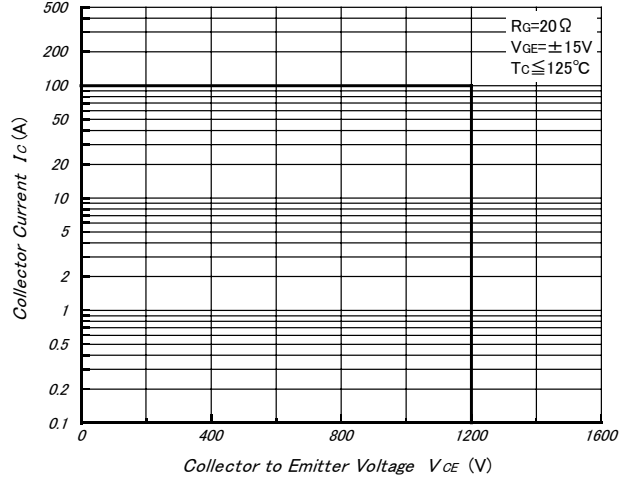

fig11-Tansient Thermal Impedance

