

Optocoupler, Photodarlington Output (Single, Dual, Quad Channel)

Features

- 125 mA Load Current Rating
- Fast Rise Time, 10 μ s
- Fast Fall Time, 35 μ s
- Single, Dual and Quad Channel
- Solid State Reliability
- Standard DIP Packages
- Lead-free component
- Component in accordance to RoHS 2002/95/EC and WEEE 2002/96/EC

Agency Approvals

- UL1577, File No. E52744 System Code H or J, Double Protection
- DIN EN 60747-5-2 (VDE0884)
DIN EN 60747-5-5 pending
Available with Option 1
- BSI IEC60950 IEC60065
- FIMKO

Description

The IL30/ IL31/ IL55 single, ILD30/ ILD31/ ILD55 dual, and ILQ30/ ILQ31/ ILQ55 quad are optically coupled isolators with Gallium Arsenide infrared emitters and silicon photodarlington sensors. Switching can be achieved while maintaining a high degree of isolation between driving and load circuits, with no crosstalk between channels. These optocouplers can be used to replace reed and mercury relays with advantages of long life, high speed switching and elimination of magnetic fields.

The IL30/ IL31/ IL55 are equivalent to MCA230/ MCA231/ MCA255. The ILD30/ ILD31/ ILD55 are designed to reduce board space requirements in high density applications.

Single Channel

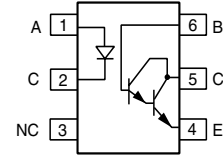
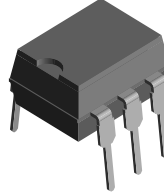

Dual Channel

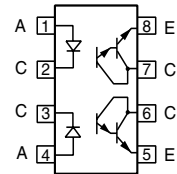
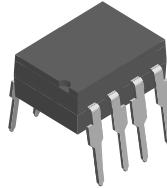

Quad Channel

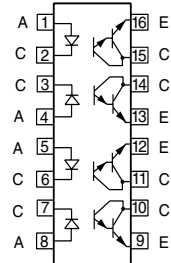
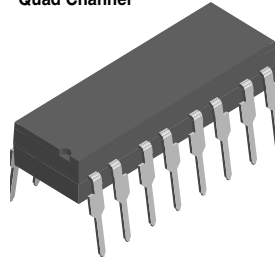

1179011



Order Information

Part	Remarks
IL30	CTR > 100 %, Single Channel DIP-6
IL31	CTR > 200 %, Single Channel DIP-6
IL55	CTR > 100 %, Single Channel DIP-6
ILD30	CTR > 100 %, Dual Channel DIP-8
ILD31	CTR > 200 %, Dual Channel DIP-8
ILD55	CTR > 100 %, Dual Channel DIP-8
ILQ30	CTR > 100 %, Quad Channel DIP-16
ILQ31	CTR > 200 %, Quad Channel DIP-16
ILQ55	CTR > 100 %, Quad Channel DIP-16
IL55-X009	CTR > 100 %, Single Channel SMD-6 (option 9)
ILD30-X009	CTR > 100 %, Dual Channel SMD-8 (option 9)
ILD31-X007	CTR > 200 %, Dual Channel SMD-8 (option 7)
ILD31-X009	CTR > 200 %, Dual Channel SMD-8 (option 9)
ILD55-X007	CTR > 100 %, Dual Channel SMD-8 (option 7)
ILD55-X009	CTR > 100 %, Dual Channel SMD-8 (option 9)
ILQ30-X009	CTR > 100 %, Quad Channel SMD-16 (option 9)
ILQ55-X007	CTR > 100 %, Quad Channel SMD-16 (option 7)
ILQ55-X009	CTR > 100 %, Quad Channel SMD-16 (option 9)

For additional information on the available options refer to Option Information.

Absolute Maximum Ratings

$T_{amb} = 25\text{ }^{\circ}\text{C}$, unless otherwise specified

Stresses in excess of the absolute Maximum Ratings can cause permanent damage to the device. Functional operation of the device is not implied at these or any other conditions in excess of those given in the operational sections of this document. Exposure to absolute Maximum Rating for extended periods of the time can adversely affect reliability.

Input

(each channel)

Parameter	Test condition	Symbol	Value	Unit
Peak reverse voltage		V_{RM}	3.0	V
Forward continuous current		I_F	60	mA
Power dissipation		P_{diss}	100	mW
Derate linearly from 25 °C			1.33	mW/°C

Output

Parameter	Test condition	Part	Symbol	Value	Unit
Collector-emitter breakdown voltage		IL30	BV_{CEO}	30	V
		ILD30	BV_{CEO}	30	V
		ILQ30	BV_{CEO}	30	V
		IL55	BV_{CEO}	55	V
		ILD55	BV_{CEO}	55	V
		ILD55	BV_{CEO}	55	V



Parameter	Test condition	Part	Symbol	Value	Unit
Collector (load) current			I_C	125	mA
Power dissipation			P_{diss}	150	mW
Derate linearly from 25 °C				2.0	mW/°C

Coupler

Parameter	Test condition	Part	Symbol	Value	Unit
Total package power dissipation		IL30	P_{tot}	250	mW
		IL31	P_{tot}	250	mW
		IL55	P_{tot}	250	mW
		ILD30	P_{tot}	400	mW
		ILD31	P_{tot}	400	mW
		ILD55	P_{tot}	400	mW
		ILQ30	P_{tot}	500	mW
		ILQ31	P_{tot}	500	mW
		ILQ55	P_{tot}	500	mW
Derate linearly from 25 °C		IL30		3.3	mW/°C
		IL31		3.3	mW/°C
		IL55		3.3	mW/°C
		ILD30		5.33	mW/°C
		ILD31		5.33	mW/°C
		ILD55		5.33	mW/°C
		ILQ30		6.67	mW/°C
		ILQ31		6.67	mW/°C
		ILQ55		6.67	mW/°C
Isolation test voltage			V_{ISO}	5300	V_{RMS}
Creepage				≥ 7.0	mm
Clearance				≥ 7.0	mm
Comparative tracking index				175	
Storage temperature			T_{stg}	- 55 to + 125	°C
Operating temperature			T_{amb}	- 55 to + 100	°C
Lead soldering time at 260 °C				10	sec.

Electrical Characteristics

$T_{amb} = 25\text{ °C}$, unless otherwise specified

Minimum and maximum values are testing requirements. Typical values are characteristics of the device and are the result of engineering evaluation. Typical values are for information only and are not part of the testing requirements.

Input

GaAs emitter (per channel)

Parameter	Test condition	Symbol	Min	Typ.	Max	Unit
Forward voltage	$I_F = 20\text{ mA}$	V_F		1.25	1.5	V
Reverse current	$V_R = 3.0\text{ V}$	I_R		0.1	10	μA
Capacitance	$V_R = 0\text{ V}$	C_O		25		pF

Output

per channel

Parameter	Test condition	Symbol	Min	Typ.	Max	Unit
Collector-emitter breakdown voltage	$I_C = 100 \mu\text{A}$	BV_{CEO}	30/55			V
Collector-emitter leakage current	$V_{CE} = 10 \text{ V}, I_F = 0$	I_{CEO}		1.0	100	nA
Collector-emitter capacitance	$V_{CE} = 10 \text{ V}, f = 1.0 \text{ MHz}$	C_{CE}		3.4		pF

Coupler

Parameter	Test condition	Symbol	Min	Typ.	Max	Unit
Collector-emitter saturation voltage	$I_C = 50 \text{ mA}, I_F = 50 \text{ mA}$	V_{CEsat}		0.9	1.0	V
Isolation test voltage			5300			V_{RMS}
Isolation resistance		R_{IO}		10^{12}		Ω
Capacitance (input-output)		C_{IO}		0.5		pF

Current Transfer Ratio

Parameter	Test condition	Part	Symbol	Min	Typ.	Max	Unit
Current Transfer Ratio	$I_F = 10 \text{ mA}, V_{CE} = 5.0 \text{ V}$	IL30	CTR	100	400		%
		IL55	CTR	100	400		%
		ILD30	CTR	100	400		%
		ILD55	CTR	100	400		%
		ILQ30	CTR	100	400		%
		ILQ55	CTR	100	400		%
		IL31	CTR	200	400		%
		ILD31	CTR	200	400		%
		ILQ31	CTR	200	400		%



Switching Characteristics

Parameter	Test condition	Symbol	Min	Typ.	Max	Unit
Rise time	$V_{CC} = 13.5\text{ V}$, $I_F = 50\text{ mA}$, $R_L = 100\ \Omega$	t_r		10		μs
Fall time	$V_{CC} = 13.5\text{ V}$, $I_F = 50\text{ mA}$, $R_L = 100\ \Omega$	t_f		35		μs

Typical Characteristics ($T_{amb} = 25\text{ }^\circ\text{C}$ unless otherwise specified)

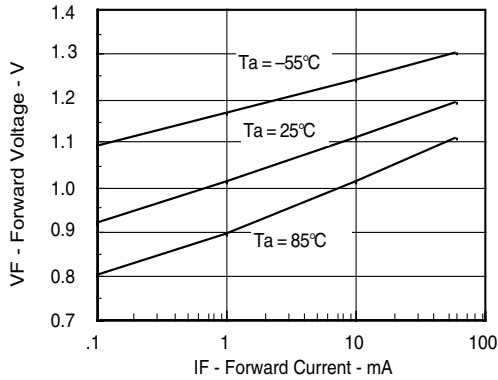

830_01

Figure 1. Forward Voltage vs. Forward Current

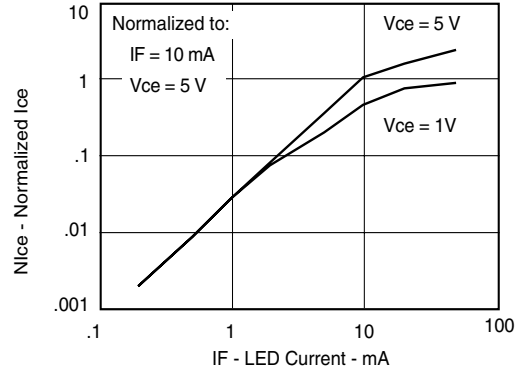

830_03

Figure 3. Normalized Non-Saturated and Saturated Collector-Emitter Current vs. LED Current

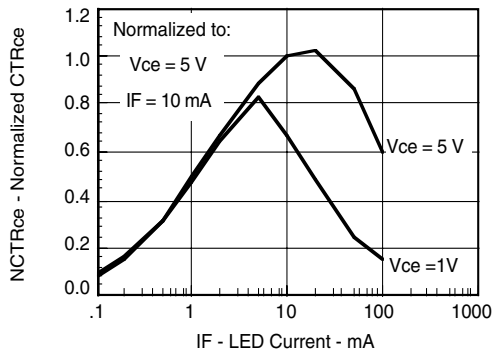

830_02

Figure 2. Normalized Non-Saturated and Saturated CTR_{CE} vs. LED Current

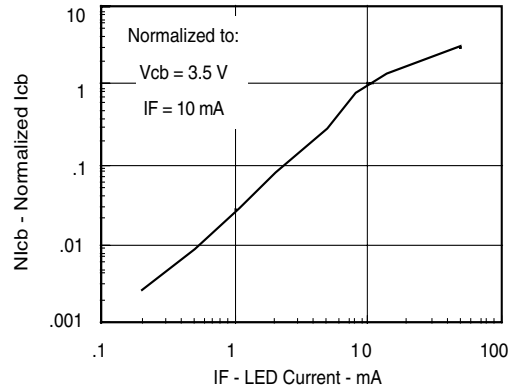

830_04

Figure 4. Normalized Collector-Base Photocurrent vs. LED Current

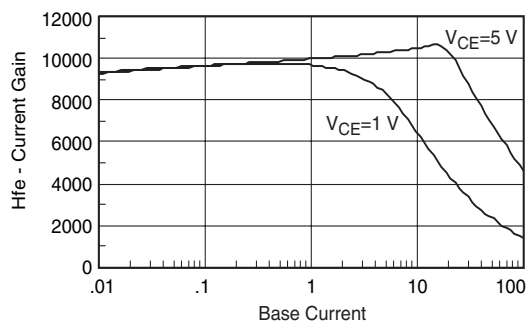

830_05

Figure 5. HFE Current Gain vs. Base Current

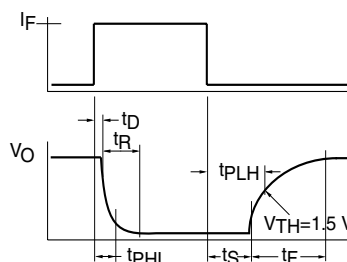

830_08

Figure 8. Switching Waveform

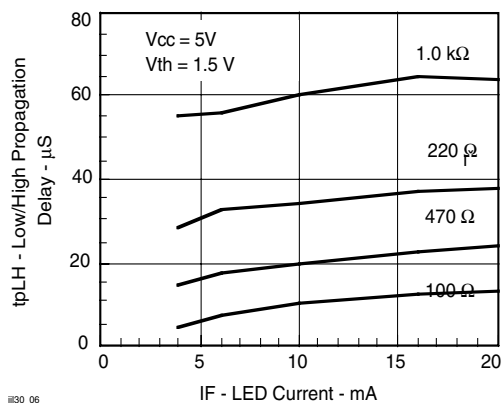

830_06

Figure 6. Low to High Propagation Delay vs. Collector Load Resistance and LED Current

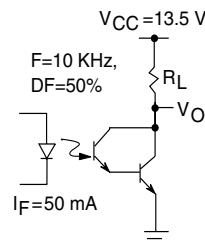

830_09

Figure 9. Switching Schematic

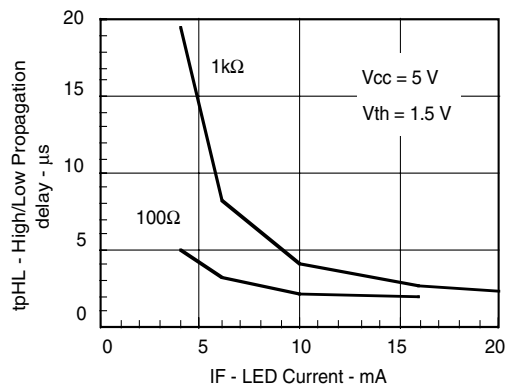

830_07

Figure 7. High to low Propagation Delay vs. Collector Load Resistance and LED Current



Package Dimensions in Inches (mm)

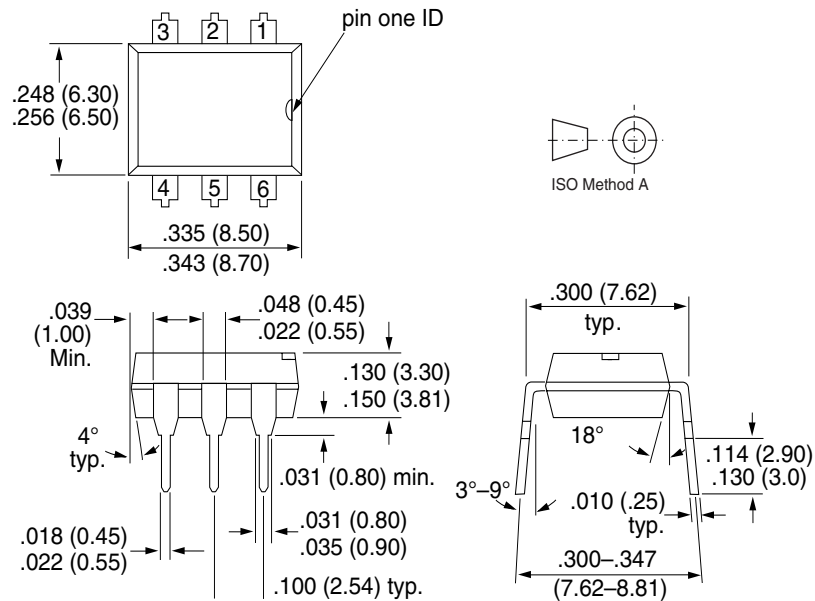

i178004

Package Dimensions in Inches (mm)

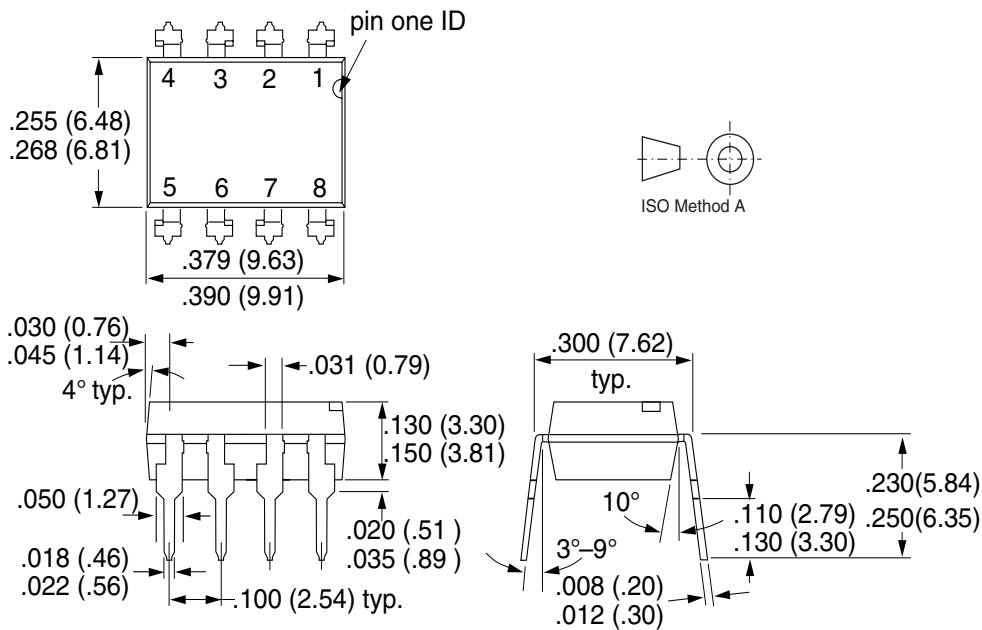

i178006

IL30/ 31/ 55/ ILD30/ 31/ 55/ ILQ30/ 31/ 55



Vishay Semiconductors

Package Dimensions in Inches (mm)

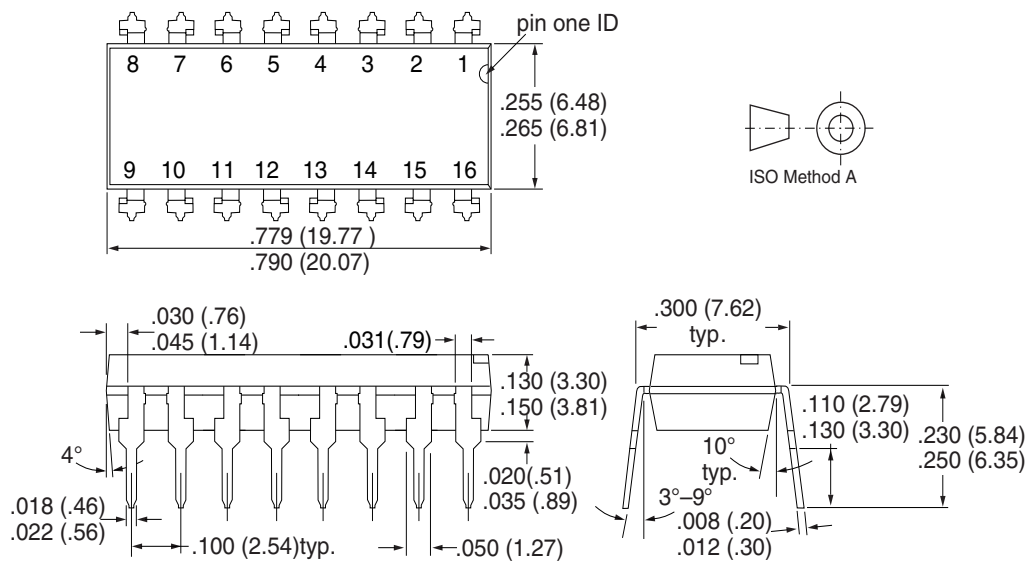

i178007

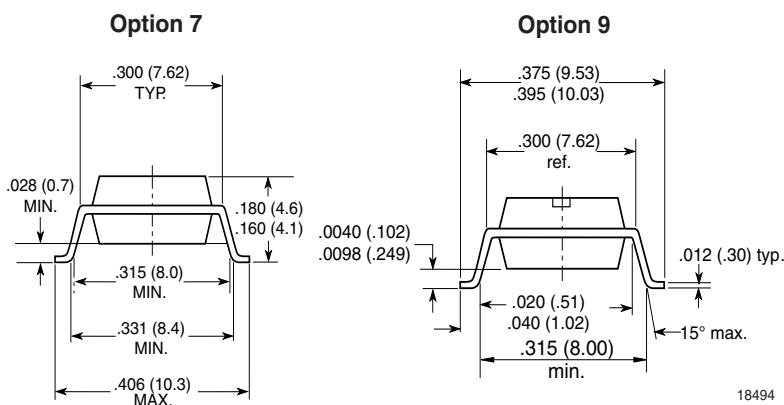



Ozone Depleting Substances Policy Statement

It is the policy of Vishay Semiconductor GmbH to

1. Meet all present and future national and international statutory requirements.
2. Regularly and continuously improve the performance of our products, processes, distribution and operating systems with respect to their impact on the health and safety of our employees and the public, as well as their impact on the environment.

It is particular concern to control or eliminate releases of those substances into the atmosphere which are known as ozone depleting substances (ODSs).

The Montreal Protocol (1987) and its London Amendments (1990) intend to severely restrict the use of ODSs and forbid their use within the next ten years. Various national and international initiatives are pressing for an earlier ban on these substances.

Vishay Semiconductor GmbH has been able to use its policy of continuous improvements to eliminate the use of ODSs listed in the following documents.

1. Annex A, B and list of transitional substances of the Montreal Protocol and the London Amendments respectively
2. Class I and II ozone depleting substances in the Clean Air Act Amendments of 1990 by the Environmental Protection Agency (EPA) in the USA
3. Council Decision 88/540/EEC and 91/690/EEC Annex A, B and C (transitional substances) respectively.

Vishay Semiconductor GmbH can certify that our semiconductors are not manufactured with ozone depleting substances and do not contain such substances.

We reserve the right to make changes to improve technical design and may do so without further notice.

Parameters can vary in different applications. All operating parameters must be validated for each customer application by the customer. Should the buyer use Vishay Semiconductors products for any unintended or unauthorized application, the buyer shall indemnify Vishay Semiconductors against all claims, costs, damages, and expenses, arising out of, directly or indirectly, any claim of personal damage, injury or death associated with such unintended or unauthorized use.

Vishay Semiconductor GmbH, P.O.B. 3535, D-74025 Heilbronn, Germany
Telephone: 49 (0)7131 67 2831, Fax number: 49 (0)7131 67 2423

Copyright © Each Manufacturing Company.

All Datasheets cannot be modified without permission.

This datasheet has been download from :

www.AllDataSheet.com

100% Free DataSheet Search Site.

Free Download.

No Register.

Fast Search System.

www.AllDataSheet.com