

SIEMENS

NPN Silicon Transistors for High Voltages

SMBTA 42
SMBTA 43

- High breakdown voltage
- Low collector-emitter saturation voltage
- Complementary types: SMBTA 92, SMBTA 93 (PNP)

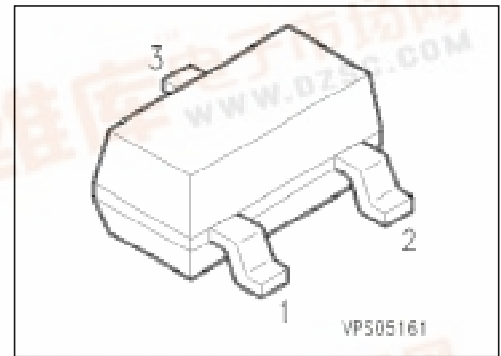

Type	Marking	Ordering Code (tape and reel)	Pin Configuration			Package ¹⁾
			1	2	3	
SMBTA 42	s1D	Q68000-A6478	B	E	C	SOT-23
SMBTA 43	s1E	Q68000-A6482				

Maximum Ratings

Parameter	Symbol	Values		Unit
		SMBTA 42	SMBTA 43	
Collector-emitter voltage	V_{CE0}	300	200	V
Collector-base voltage	V_{CB0}	300	200	
Emitter-base voltage	V_{EB0}	6		
Collector current	I_C	500		mA
Base current	I_B	100		
Total power dissipation, $T_s = 74\text{ °C}$	P_{tot}	360		mW
Junction temperature	T_j	150		
Storage temperature range	T_{stg}	- 65 ... + 150		

Thermal Resistance

Junction - ambient ²⁾	$R_{th JA}$	≤ 280	K/W
Junction - soldering point	$R_{th JS}$	≤ 210	

1) For detailed information see chapter Package Outlines.

2) Package mounted on epoxy pcb 40 mm × 40 mm × 1.5 mm/6 cm² Cu.



Electrical Characteristics

at $T_A = 25\text{ °C}$, unless otherwise specified.

Parameter	Symbol	Values			Unit
		min.	typ.	max.	

DC characteristics

Collector-emitter breakdown voltage $I_C = 1\text{ mA}$	SMBTA 42 SMBTA 43	$V_{(BR)CE0}$	300 200	— —	— —	V
Collector-base breakdown voltage $I_C = 100\text{ }\mu\text{A}$	SMBTA 42 SMBTA 43	$V_{(BR)CB0}$	300 200	— —	— —	
Emitter-base breakdown voltage $I_E = 100\text{ }\mu\text{A}$		$V_{(BR)EB0}$	6	—	—	
Collector-base cutoff current $V_{CB} = 200\text{ V}$ $V_{CB} = 160\text{ V}$ $V_{CB} = 200\text{ V}, T_A = 150\text{ °C}$ $V_{CB} = 160\text{ V}, T_A = 150\text{ °C}$	SMBTA 42 SMBTA 43 SMBTA 42 SMBTA 43	I_{CB0}	— — — —	— — — —	100 100 20 20	nA nA μA μA
Emitter-base cutoff current $V_{EB} = 3\text{ V}$		I_{EB0}	—	—	100	nA
DC current gain $I_C = 1\text{ mA}, V_{CE} = 10\text{ V}$ $I_C = 10\text{ mA}, V_{CE} = 10\text{ V}^{1)}$ $I_C = 30\text{ mA}, V_{CE} = 10\text{ V}^{1)}$	SMBTA 42 SMBTA 43	h_{FE}	25 40 40 40	— — — —	— — — —	—
Collector-emitter saturation voltage ¹⁾ $I_C = 20\text{ mA}, I_B = 2\text{ mA}$	SMBTA 42 SMBTA 43	V_{CEsat}	— —	— —	0.5 0.4	V
Base-emitter saturation voltage ¹⁾ $I_C = 20\text{ mA}, I_B = 2\text{ mA}$		V_{BEsat}	—	—	0.9	

AC characteristics

Transition frequency $I_C = 10\text{ mA}, V_{CE} = 20\text{ V}, f = 100\text{ MHz}$		f_t	50	—	—	MHz
Output capacitance $V_{CB} = 20\text{ V}, f = 1\text{ MHz}$	SMBTA 42 SMBTA 43	C_{obo}	— —	— —	3 4	pF

¹⁾ Pulse test conditions: $t \leq 300\text{ }\mu\text{s}, D = 2\%$.

Total power dissipation $P_{tot} = f(T_A^*; T_S)$
* Package mounted on epoxy

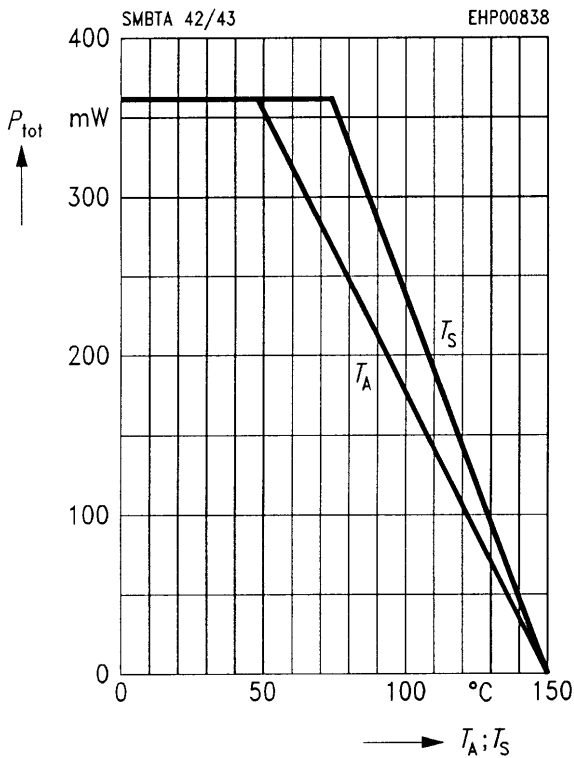

Transition frequency $f_T = f(I_C)$
 $V_{CE} = 10\text{ V}, f = 100\text{ MHz}$

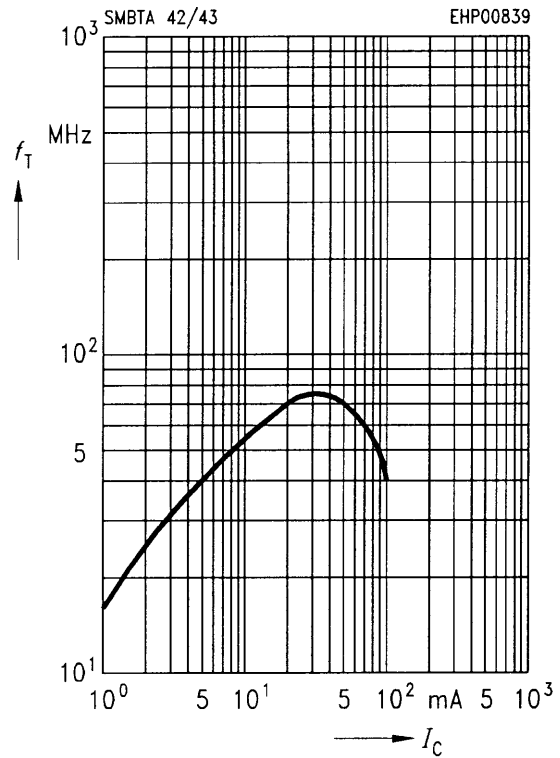

Permissible pulse load $P_{tot\ max}/P_{tot\ DC} = f(t_p)$

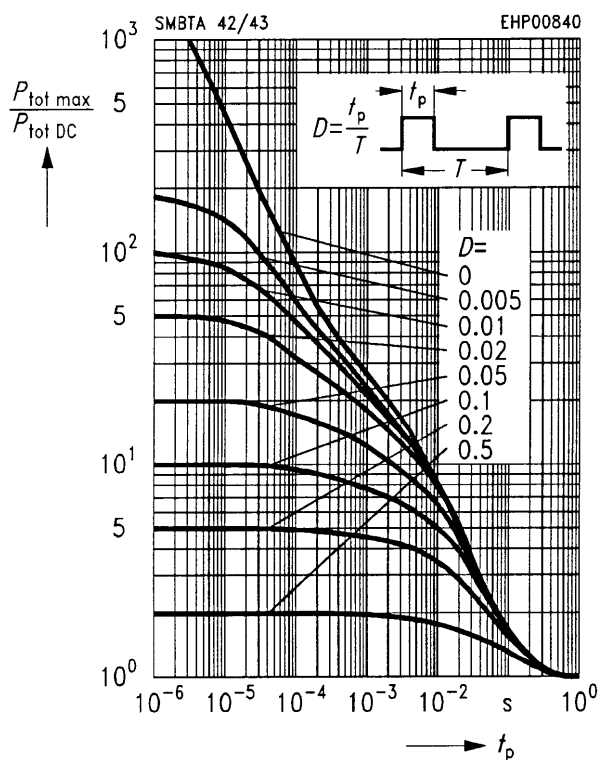

Operating range $I_C = f(V_{CE0})$
 $T_A = 25\text{ °C}, D = 0$

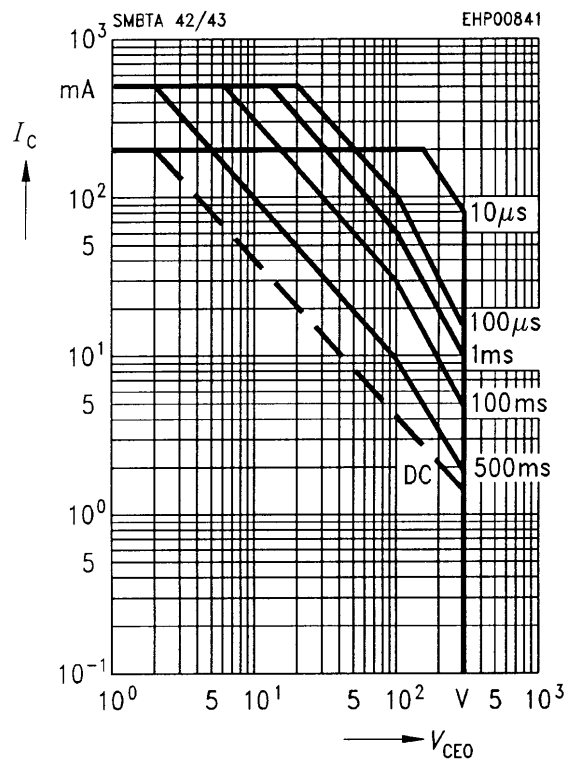

Collector cutoff current $I_{CB0} = f(T_A)$
 $V_{CB} = 160 \text{ V}$

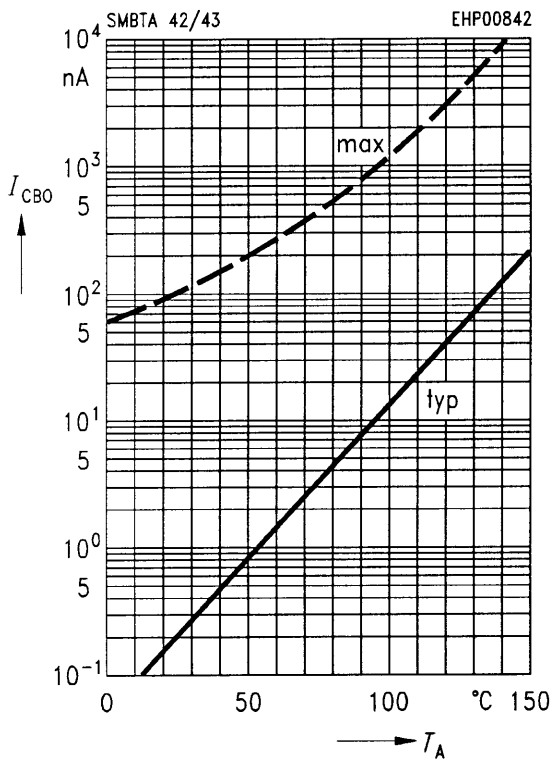

Collector current $I_C = f(V_{BE})$
 $V_{CE} = 10 \text{ V}$

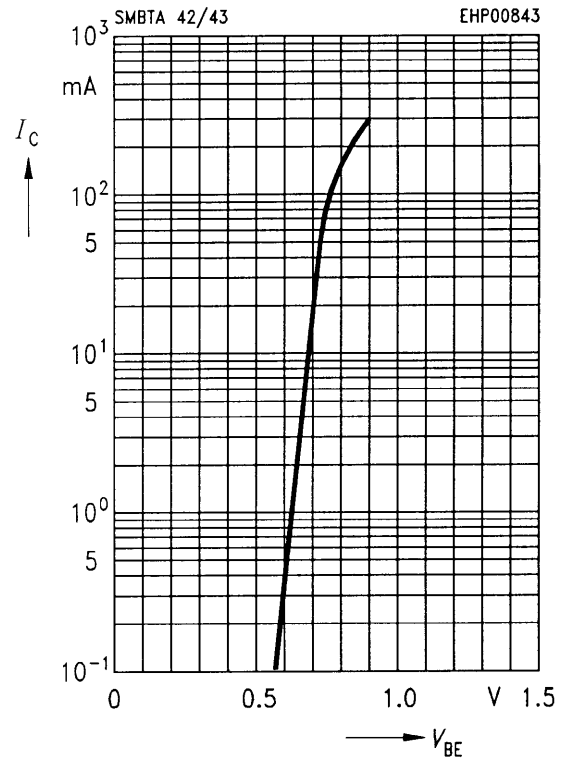

DC current gain $h_{FE} = f(I_C)$
 $V_{CE} = 10 \text{ V}$

