

QED233

QED234

PACKAGE DIMENSIONS

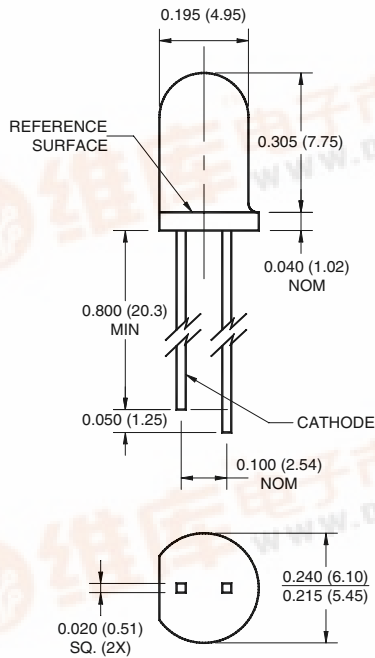

NOTES:

1. Dimensions for all drawings are in inches (mm).
2. Tolerance of $\pm .010 (.25)$ on all non-nominal dimensions unless otherwise specified.



SCHEMATIC

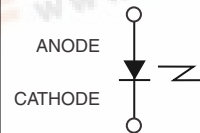

DESCRIPTION

The QED233 / QED234 is a 940 nm GaAs / AlGaAs LED encapsulated in a clear untinted, plastic T-1 3/4 package.

FEATURES

- $\lambda = 940$ nm
- Chip material = GaAs with AlGaAs window
- Package type: T-1 3/4 (5mm lens diameter)
- Matched Photosensor: QSD122/123/124
- Medium Emission Angle, 40°
- High Output Power
- Package material and color: Clear, untinted, plastic
- Ideal for remote control applications



QED233

QED234

ABSOLUTE MAXIMUM RATINGS ($T_A = 25^\circ\text{C}$ unless otherwise specified)

Parameter	Symbol	Rating	Unit
Operating Temperature	T_{OPR}	-40 to +100	$^\circ\text{C}$
Storage Temperature	T_{STG}	-40 to +100	$^\circ\text{C}$
Soldering Temperature (Iron) ^(2,3,4)	$T_{\text{SOL-I}}$	240 for 5 sec	$^\circ\text{C}$
Soldering Temperature (Flow) ^(2,3)	$T_{\text{SOL-F}}$	260 for 10 sec	$^\circ\text{C}$
Continuous Forward Current	I_F	100	mA
Reverse Voltage	V_R	5	V
Power Dissipation ⁽¹⁾	P_D	200	mW
Peak Forward Current	I_{FP}	1.5	A

1. Derate power dissipation linearly 2.67 mW/ $^\circ\text{C}$ above 25 $^\circ\text{C}$.
2. RMA flux is recommended.
3. Methanol or isopropyl alcohols are recommended as cleaning agents.
4. Soldering iron 1/16" (1.6mm) minimum from housing.
5. Pulse conditions; $t_p = 100 \mu\text{s}$, $T = 10 \text{ ms}$.

ELECTRICAL / OPTICAL CHARACTERISTICS ($T_A = 25^\circ\text{C}$)

PARAMETER	TEST CONDITIONS	DEVICE	SYMBOL	MIN	TYP	MAX	UNITS
Peak Emission Wavelength	$I_F = 20 \text{ mA}$	ALL	λ_{PE}	—	940	—	nm
Spectral Bandwidth	$I_F = 20 \text{ mA}$	ALL	—	50	—	nm	
Temp. Coefficient of λ_{PE}	$I_F = 100 \text{ mA}$	ALL	TC_λ	—	0.2	—	nm/K
Emission Angle	$I_F = 100 \text{ mA}$	ALL	$2\theta_{1/2}$	—	40	—	Deg.
Forward Voltage	$I_F = 100 \text{ mA}$, $t_p = 20 \text{ ms}$	ALL	V_F	—	—	1.6	V
Temp. Coefficient of V_F	$I_F = 100 \text{ mA}$	ALL	TC_V	—	-1.5	—	mV/K
Reverse Current	$V_R = 5 \text{ V}$	ALL	I_R	—	—	10	μA
Radiant Intensity	$I_F = 100 \text{ mA}$, $t_p = 20 \text{ ms}$	QED233	I_E	10	—	50	mW/sr
		QED234		27	—	—	
Temp. Coefficient of I_E	$I_F = 20 \text{ mA}$	ALL	TC_I	—	-0.6	—	%/K
Rise Time	$I_F = 100 \text{ mA}$	ALL	t_r	—	1000	—	ns
Fall Time		ALL	t_f	—	1000	—	

QED233

QED234

TYPICAL PERFORMANCE CURVES TBD

Fig. 1 Normalized Radiant Intensity vs. Forward Current

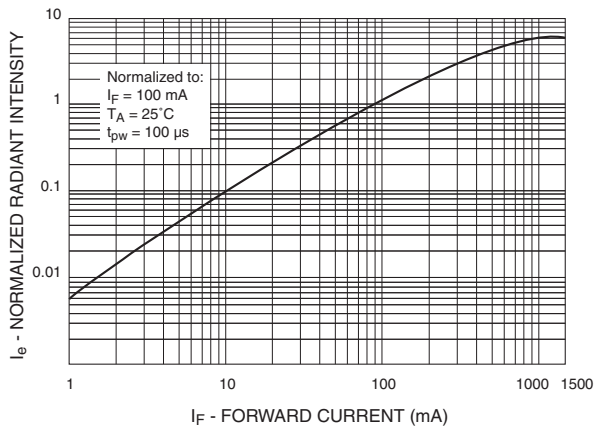

Fig. 2 Forward Voltage Vs. Ambient Temperature

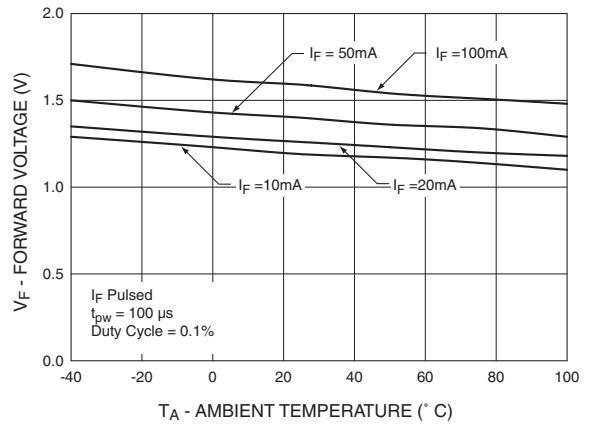

Fig. 3 Normalized Radiant Intensity vs. Wavelength

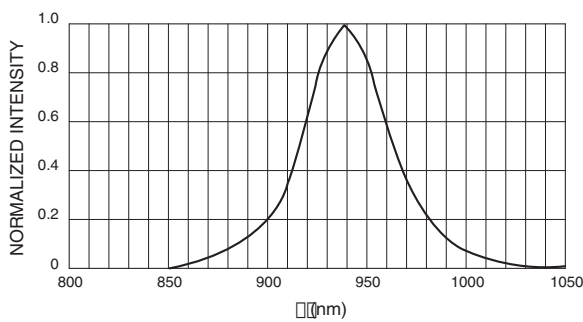

Fig. 4 Radiation Diagram

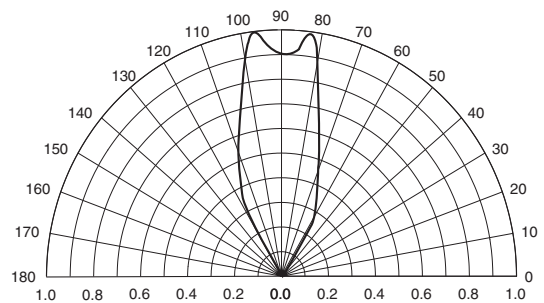
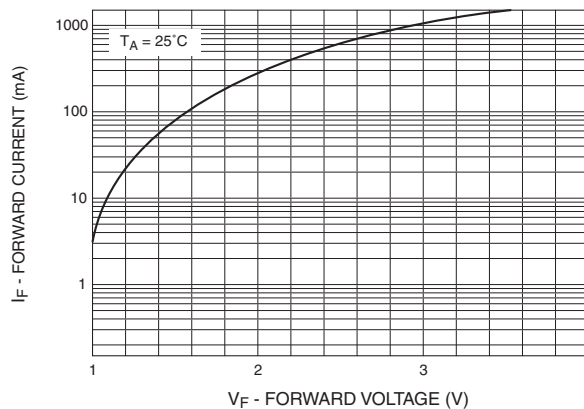

Fig. 5 Forward Current vs. Forward Voltage



QED233

QED234

DISCLAIMER

FAIRCHILD SEMICONDUCTOR RESERVES THE THE RIGHT TO MAKE CHANGES WITHOUT FURTHER NOTICE TO ANY PRODUCTS HEREIN TO IMPROVE RELIABILITY, FUNCTION OR DESIGN. FAIRCHILD DOES NOT ASSUME ANY LIABILITY ARISING OUT OF THE APPLICATION OR USE OF ANY PRODUCT OR CIRCUIT DESCRIBED HEREIN; NEITHER DOES IT CONVEY ANY LICENSE UNDER ITS PATENT RIGHTS, NOR THE RIGHTS OF OTHERS.

LIFE SUPPORT POLICY

FAIRCHILD'S PRODUCTS ARE NOT AUTHORIZED FOR USE AS CRITICAL COMPONENTS IN LIFE SUPPORT DEVICES OR SYSTEMS WITHOUT THE EXPRESS WRITTEN APPROVAL OF THE PRESIDENT OF FAIRCHILD SEMICONDUCTOR CORPORATION. As used herein:

1. Life support devices or systems are devices or systems which, (a) are intended for surgical implant into the body, or (b) support or sustain life, and (c) whose failure to perform when properly used in accordance with instructions for use provided in labeling, can be reasonably expected to result in a significant injury of the user.
2. A critical component in any component of a life support device or system whose failure to perform can be reasonably expected to cause the failure of the life support device or system, or to affect its safety or effectiveness.