

SBVS026C – JULY 2001

DMOS 100mA Low-Dropout Regulator

FEATURES

- **NEW DMOS TOPOLOGY:**
 Ultra Low Dropout Voltage:
 60mV typ at 100mA
 Output capacitor NOT required for stability
- **FAST TRANSIENT RESPONSE**
- **VERY LOW NOISE:** 23 μ Vrms
- **HIGH ACCURACY:** \pm 1.5% max
- **HIGH EFFICIENCY:**
 $I_{GND} = 500\mu A$ at $I_{OUT} = 100mA$
 Not Enabled: $I_{GND} = 10nA$
- **2.5V, 2.8V, 2.85V, 3.0V, 3.3V, 5.0V, AND
 ADJUSTABLE OUTPUT VERSIONS**
- **OTHER OUTPUT VOLTAGES AVAILABLE UPON
 REQUEST**
- **FOLDBACK CURRENT LIMIT**
- **THERMAL PROTECTION**
- **SMALL SURFACE-MOUNT PACKAGES:**
 SOT23-5 and SO-8

APPLICATIONS

- **PORTABLE COMMUNICATION DEVICES**
- **BATTERY-POWERED EQUIPMENT**
- **PERSONAL DIGITAL ASSISTANTS**
- **MODEMS**
- **BAR-CODE SCANNERS**
- **BACKUP POWER SUPPLIES**

DESCRIPTION

The REG101 is a family of low-noise, low-dropout linear regulators with low ground pin current. Its new DMOS topology provides significant improvement over previous designs, including low dropout voltage (only 60mV typ at full load), and better transient performance. In addition, no output capacitor is required for stability, unlike conventional low-dropout regulators that are difficult to compensate and require expensive low ESR capacitors greater than 1 μ F.

Typical ground pin current is only 500 μ A (at $I_{OUT} = 100mA$) and drops to 10nA when not in enabled mode. Unlike regulators with PNP pass devices, quiescent current remains relatively constant over load variation and under dropout conditions.

The REG101 has very low output noise (typically 23 μ Vrms for $V_{OUT} = 3.3V$ with $C_{NR} = 0.01\mu F$), making it ideal for use in portable communications equipment. Accuracy is maintained over temperature, line, and load variations. Key parameters are tested over the specified temperature range ($-40^{\circ}C$ to $+85^{\circ}C$).

The REG101 is well protected—internal circuitry provides a current limit that protects the load from damage. Thermal protection circuitry keeps the chip from being damaged by excessive temperature. The REG101 is available in the SOT23-5 and the SO-8 packages.

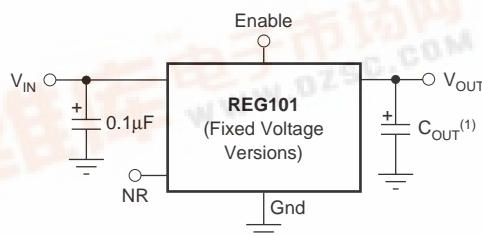

NR = Noise Reduction

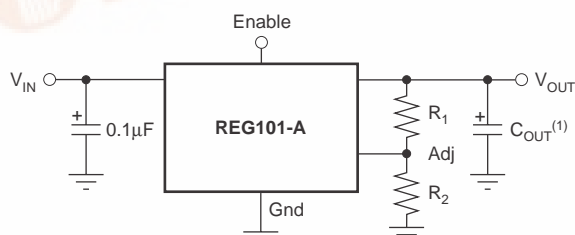

NOTE: (1) Optional.

Please be aware that an important notice concerning availability, standard warranty, and use in critical applications of Texas Instruments semiconductor products and disclaimers thereto appears at the end of this data sheet.

ABSOLUTE MAXIMUM RATINGS⁽¹⁾

Supply Input Voltage, V_{IN}	-0.3V to 12V
Enable Input	-0.3V to V_{IN}
Output Short-Circuit Duration	Indefinite
Operating Temperature Range (T_J)	-55°C to +125°C
Storage Temperature Range (T_A)	-65°C to +150°C
Lead Temperature (soldering, 3s, SOT23-5, and SO-8)	+240°C

NOTE: (1) Stresses above these ratings may cause permanent damage. Exposure to absolute maximum conditions for extended periods may degrade device reliability.



ELECTROSTATIC DISCHARGE SENSITIVITY

This integrated circuit can be damaged by ESD. Texas Instruments recommends that all integrated circuits be handled with appropriate precautions. Failure to observe proper handling and installation procedures can cause damage.

ESD damage can range from subtle performance degradation to complete device failure. Precision integrated circuits may be more susceptible to damage because very small parametric changes could cause the device not to meet its published specifications.

PACKAGE/ORDERING INFORMATION

PRODUCT	PACKAGE	PACKAGE DRAWING NUMBER	PACKAGE MARKING	ORDERING NUMBER ⁽¹⁾	TRANSPORT MEDIA
5V Output					
REG101NA-5	SOT23-5	331	R01B	REG101NA-5/250	Tape and Reel
"	"	"	"	REG101NA-5/3K	Tape and Reel
REG101UA-5	SO-8	182	REG101U50	REG101UA-5	Rails
"	"	"	"	REG101UA-5/2K5	Tape and Reel
3.3V Output					
REG101NA-3.3	SOT23-5	331	R01C	REG101NA-3.3/250	Tape and Reel
"	"	"	"	REG101NA-3.3/3K	Tape and Reel
REG101UA-3.3	SO-8	182	REG101U33	REG101UA-3.3	Rails
"	"	"	"	REG101UA-3.3/2K5	Tape and Reel
3V Output					
REG101NA-3	SOT23-5	331	R01D	REG101NA-3/250	Tape and Reel
"	"	"	"	REG101NA-3/3K	Tape and Reel
REG101UA-3	SO-8	182	REG101U30	REG101UA-3	Rails
"	"	"	"	REG101UA-3/2K5	Tape and Reel
2.85V Output					
REG101NA-2.85	SOT23-5	331	R01N	REG101NA-2.85/250	Tape and Reel
"	"	"	"	REG101NA-2.85/3K	Tape and Reel
REG101UA-2.85	SO-8	182	REG101285	REG101UA-2.85	Rails
"	"	"	"	REG101UA-2.85/2K5	Tape and Reel
2.8V Output					
REG101NA-2.8	SOT23-5	331	R01E	REG101NA-2.8/250	Tape and Reel
"	"	"	"	REG101NA-2.8/3K	Tape and Reel
REG101UA-2.8	SO-8	182	REG101U28	REG101UA-2.8	Rails
"	"	"	"	REG101UA-2.8/2K5	Tape and Reel
2.5V Output					
REG101NA-2.5	SOT23-5	331	R01G	REG101NA-2.5/250	Tape and Reel
"	"	"	"	REG101NA-2.5/3K	Tape and Reel
REG101UA-2.5	SO-8	182	REG101U25	REG101UA-2.5	Rails
"	"	"	"	REG101UA-2.5/2K5	Tape and Reel
Adjustable Output					
REG101NA-A	SOT23-5	331	R01A	REG101NA-A/250	Tape and Reel
"	"	"	"	REG101NA-A/3K	Tape and Reel
REG101UA-A	SO-8	182	REG101UA	REG101UA-A	Rails
"	"	"	"	REG101UA-A/2K5	Tape and Reel

NOTE: (1) Models with a slash (/) are available only in Tape and Reel in the quantities indicated (e.g., /2K5 indicates 2500 devices per reel). Ordering 2500 pieces of "REG101UA-5/2K5" will get a single 2500-piece Tape and Reel.

Many custom output voltage versions, from 2.5V to 5.1V in 50mV increments, are available upon request. Minimum order quantities apply. Contact factory for details.

ELECTRICAL CHARACTERISTICS

Boldface limits apply over the specified temperature range, $T_J = -40^{\circ}\text{C}$ to $+85^{\circ}\text{C}$.

At $T_J = +25^{\circ}\text{C}$, $V_{IN} = V_{OUT} + 1\text{V}$ ($V_{OUT} = 2.5\text{V}$ for REG101-A), $V_{ENABLE} = 1.8\text{V}$, $I_{OUT} = 2\text{mA}$, $C_{NR} = 0.01\mu\text{F}$, and $C_{OUT} = 0.1\mu\text{F}^{(1)}$, unless otherwise noted.

PARAMETER	CONDITION	REG101NA REG101UA			UNITS	
		MIN	TYP	MAX		
OUTPUT VOLTAGE						
Output Voltage	V_{OUT}				V	
REG101-2.5			2.5		V	
REG101-2.8			2.8		V	
REG101-2.85			2.85		V	
REG101-3.0			3.0		V	
REG101-3.3			3.3		V	
REG101-5			5		V	
REG101-A		2.5		5.5	V	
Reference Voltage	V_{REF}		1.267		V	
Adjust Pin Current	I_{ADJ}		0.2	1	μA	
Accuracy			± 0.5	± 1.5	%	
Over Temperature vs Temperature	dV_{OUT}/dT		50	± 2.2	%	
Includes Line and Load		$I_{OUT} = 2\text{mA}$ to 100mA , $V_{IN} = (V_{OUT} + 0.4\text{V})$ to 10V	± 0.8	± 2.0	%	
Over Temperature		$V_{IN} = (V_{OUT} + 0.6\text{V})$ to 10V		± 2.7	%	
DC DROPOUT VOLTAGE⁽²⁾	V_{DROP}				mV	
For all models		$I_{OUT} = 2\text{mA}$	4	10	mV	
		$I_{OUT} = 100\text{mA}$	60	100	mV	
Over Temperature		$I_{OUT} = 100\text{mA}$		130	mV	
VOLTAGE NOISE	V_n	$f = 10\text{Hz}$ to 100kHz			μVrms	
Without C_{NR}		$C_{NR} = 0$, $C_{OUT} = 0$	23 $\mu\text{Vrms/V} \cdot V_{OUT}$		μVrms	
With C_{NR} (all fixed voltage models)		$C_{NR} = 0.01\mu\text{F}$, $C_{OUT} = 10\mu\text{F}$	7 $\mu\text{Vrms/V} \cdot V_{OUT}$		μVrms	
OUTPUT CURRENT						
Current Limit ⁽³⁾	I_{CL}		130	170	220	mA
Over Temperature			110		240	mA
Short-Circuit Current	I_{SC}			60		mA
RIPPLE REJECTION						
$f = 120\text{Hz}$		$I_{OUT} = 100\text{mA}$		65		dB
ENABLE CONTROL						
V_{ENABLE} High (output enabled)	V_{ENABLE}		1.8		V_{IN}	V
V_{ENABLE} Low (output disabled)			-0.2		0.5	V
I_{ENABLE} High (output enabled)	I_{ENABLE}	$V_{ENABLE} = 1.8\text{V}$ to V_{IN} , $V_{IN} = 1.8\text{V}$ to $6.5^{(4)}$		1	100	nA
I_{ENABLE} Low (output disabled)		$V_{ENABLE} = 0\text{V}$ to 0.5V		2	100	nA
Output Disable Time		$C_{OUT} = 1.0\mu\text{F}$, $R_{LOAD} = 33\Omega$		200		μs
Output Enable Time		$C_{OUT} = 1.0\mu\text{F}$, $R_{LOAD} = 33\Omega$		1.5		ms
THERMAL SHUTDOWN						
Junction Temperature Shutdown				160		$^{\circ}\text{C}$
Reset from Shutdown				140		$^{\circ}\text{C}$
GROUND PIN CURRENT						
Ground Pin Current	I_{GND}	$I_{OUT} = 2\text{mA}$		400	500	μA
		$I_{OUT} = 100\text{mA}$		500	650	μA
Enable Pin Low		$V_{ENABLE} \leq 0.5\text{V}$		0.01	0.2	μA
INPUT VOLTAGE	V_{IN}					
Operating Input Voltage Range ⁽⁵⁾			1.8		10	V
Specified Input Voltage Range		$V_{IN} > 1.8\text{V}$	$V_{OUT} + 0.4$		10	V
Over Temperature		$V_{IN} > 1.8\text{V}$	$V_{OUT} + 0.6$		10	V
TEMPERATURE RANGE						
Specified Range	T_J		-40		+85	$^{\circ}\text{C}$
Operating Range	T_J		-55		+125	$^{\circ}\text{C}$
Storage Range	T_A		-65		+150	$^{\circ}\text{C}$
Thermal Resistance						
SOT23-5 Surface Mount	θ_{JA}	Junction-to-Ambient		200		$^{\circ}\text{C/W}$
SO-8 Surface Mount	θ_{JA}	Junction-to-Ambient		150		$^{\circ}\text{C/W}$

NOTES: (1) The REG101 does not require a minimum output capacitor for stability. However, transient response can be improved with proper capacitor selection. (2) Dropout voltage is defined as the input voltage minus the output voltage that produces a 2% change in the output voltage from the value at $V_{IN} = V_{OUT} + 1\text{V}$ at fixed load. (3) Current limit is the output current that produces a 10% change in output voltage from $V_{IN} = V_{OUT} + 1\text{V}$ and $I_{OUT} = 2\text{mA}$. (4) For $V_{ENABLE} > 6.5\text{V}$, see typical characteristic " I_{ENABLE} vs V_{ENABLE} ". (5) The REG101 no longer regulates when $V_{IN} < V_{OUT} + V_{DROP(MAX)}$. In drop-out, the impedance from V_{IN} to V_{OUT} is typically less than 1Ω at $T_J = +25^{\circ}\text{C}$.

PIN CONFIGURATIONS

Top View

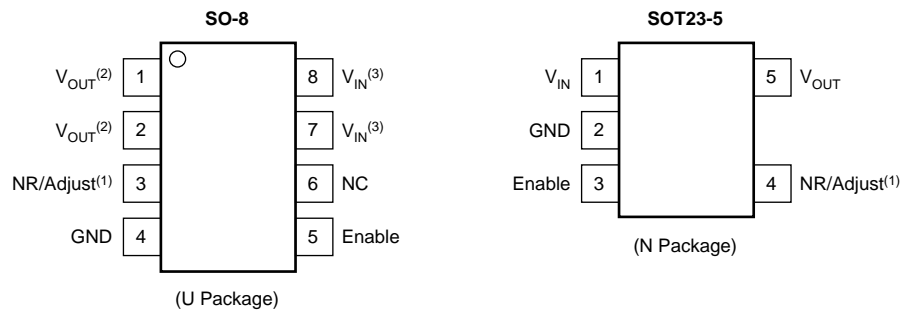

NOTE: (1) For REG101A-A: voltage setting resistor pin. All other models: noise reduction capacitor pin.
(2) Both pin 1 and pin 2 must be connected.
(3) Both pin 7 and pin 8 must be connected.

TYPICAL CHARACTERISTICS

For all models, at $T_J = +25^\circ\text{C}$ and $V_{\text{ENABLE}} = 1.8\text{V}$, unless otherwise noted.

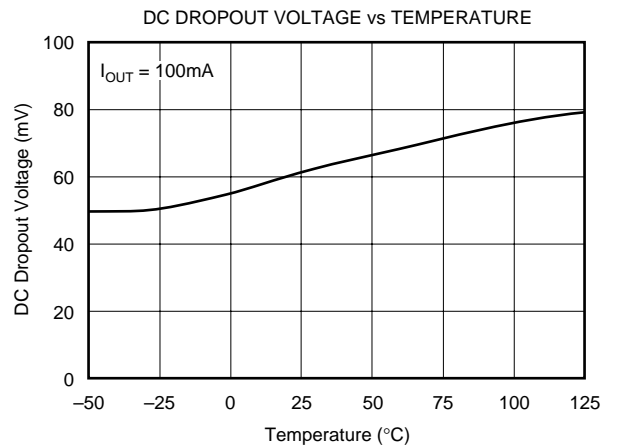
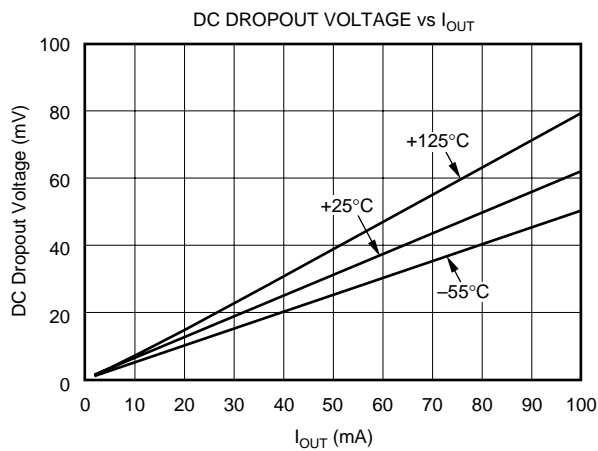
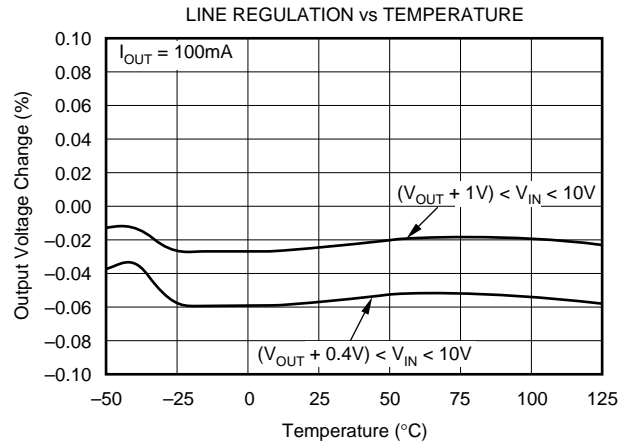
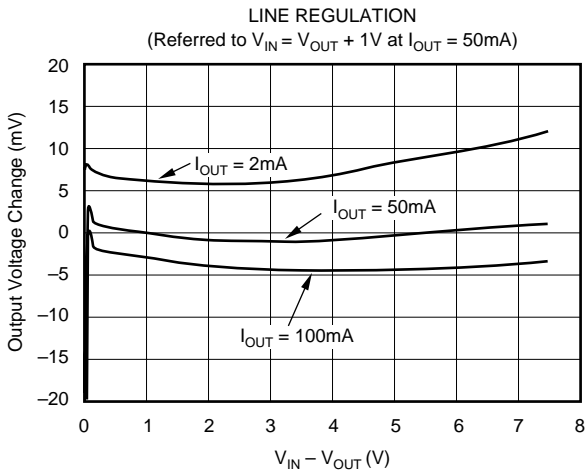
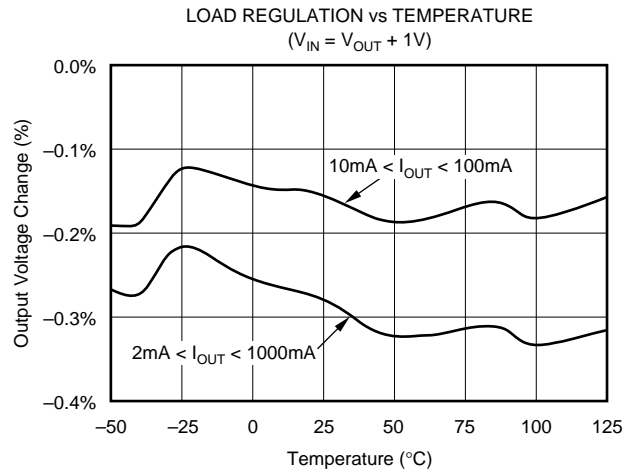
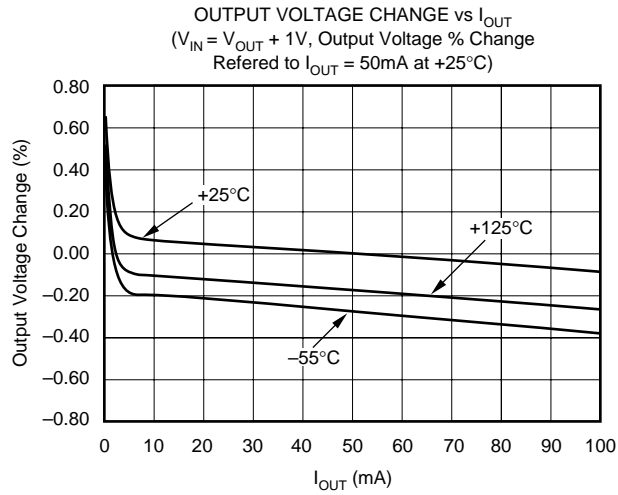

TYPICAL CHARACTERISTICS (Cont.)

For all models, at $T_J = +25^\circ\text{C}$ and $V_{\text{ENABLE}} = 1.8\text{V}$, unless otherwise noted.

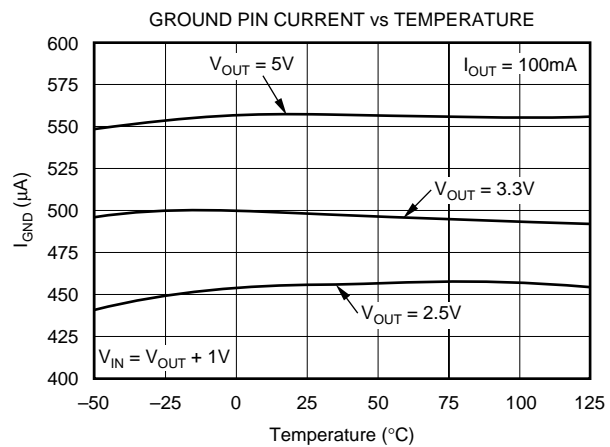
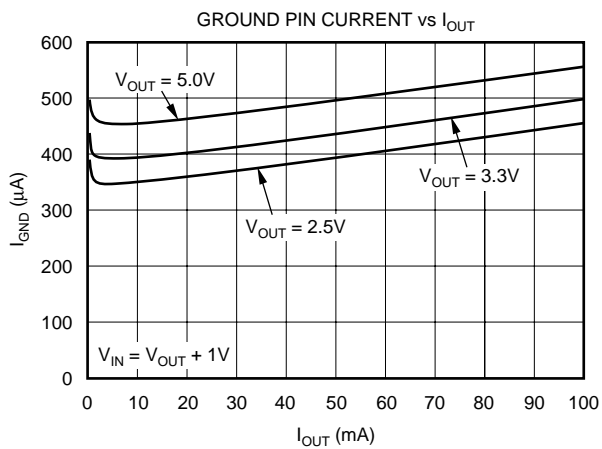
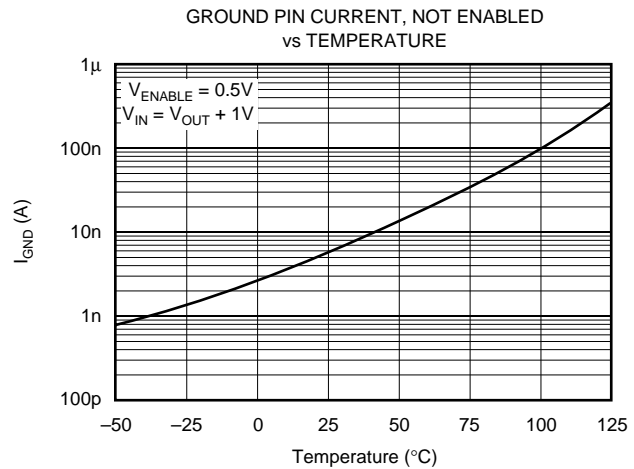
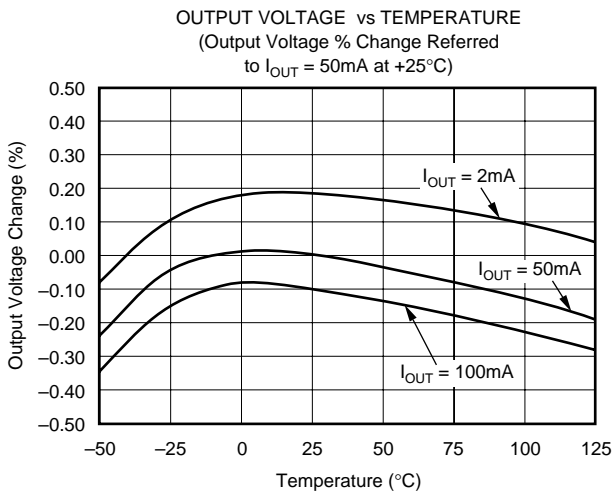
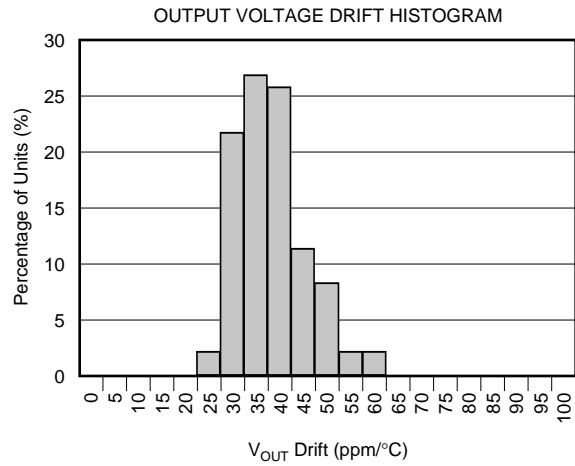
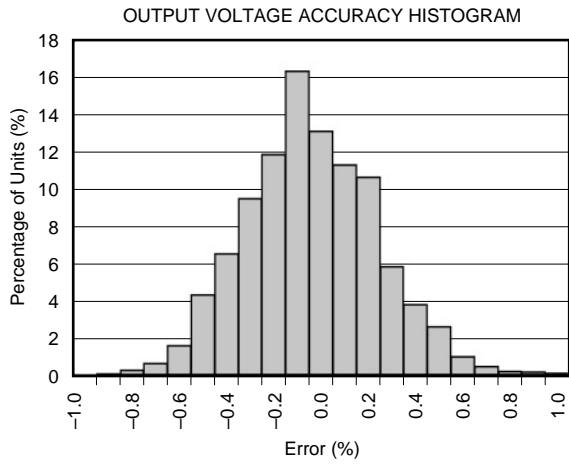

TTYPICAL CHARACTERISTICS (Cont.)

For all models, at $T_J = +25^\circ\text{C}$ and $V_{\text{ENABLE}} = 1.8\text{V}$, unless otherwise noted.

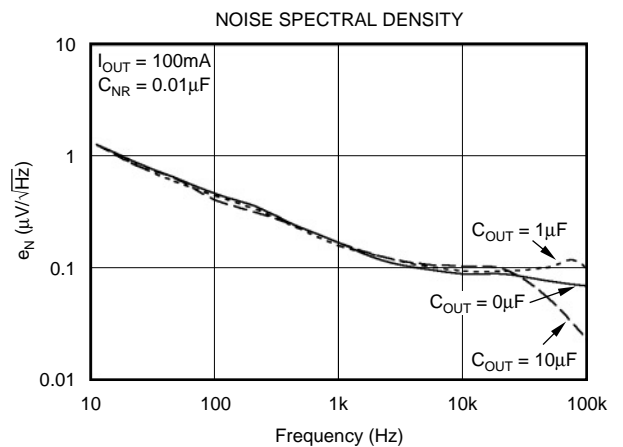
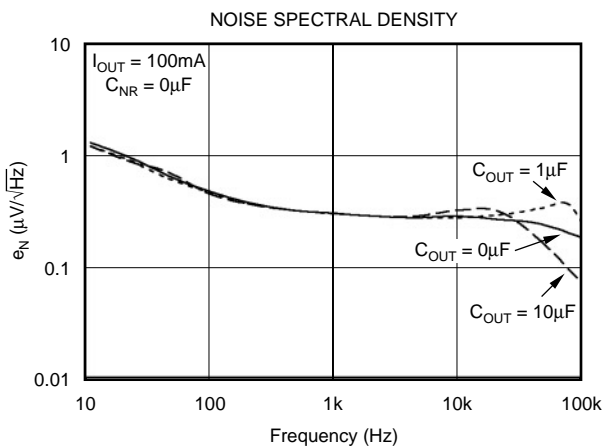
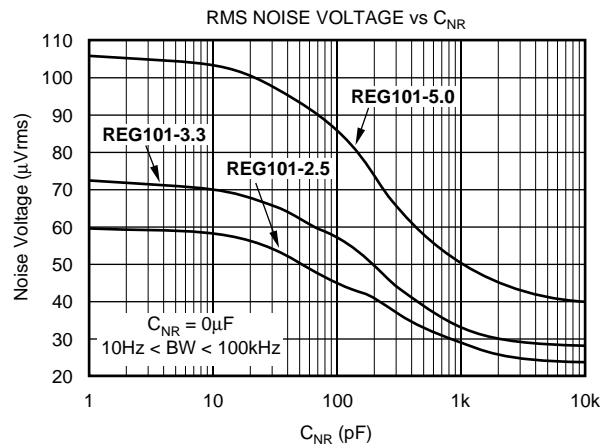
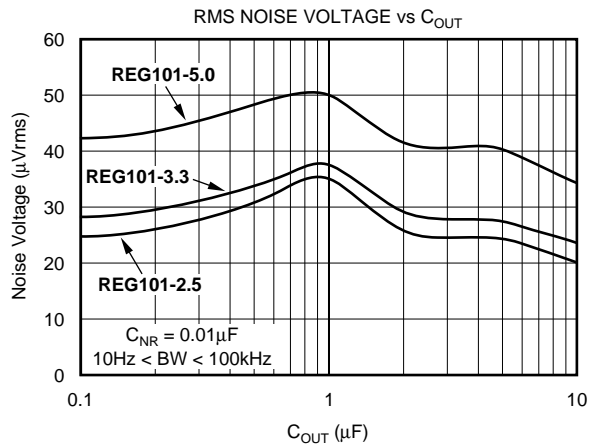
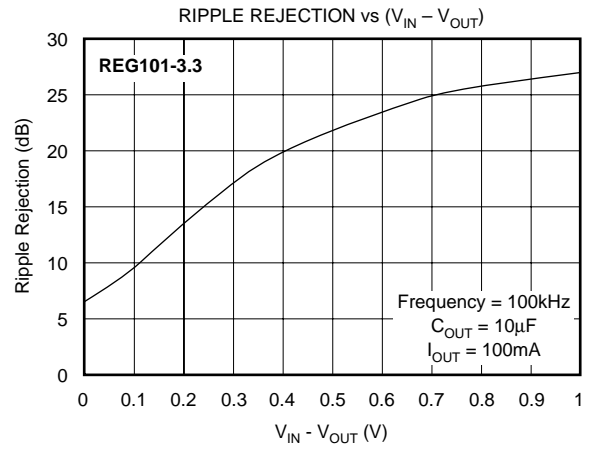
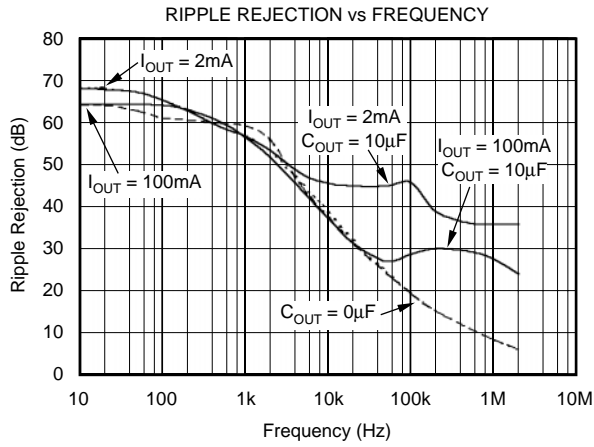

TYPICAL CHARACTERISTICS (Cont.)

For all models, at $T_J = +25^\circ\text{C}$ and $V_{\text{ENABLE}} = 1.8\text{V}$, unless otherwise noted.

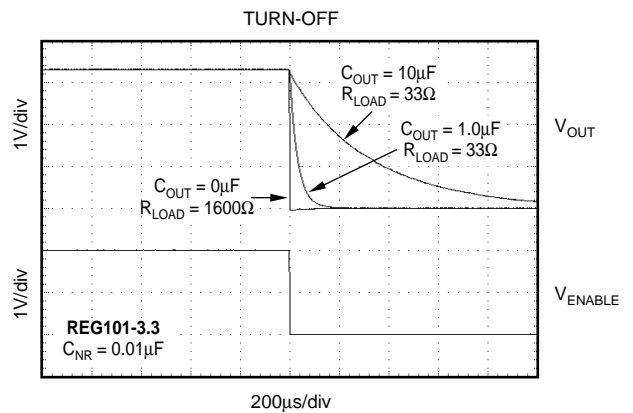
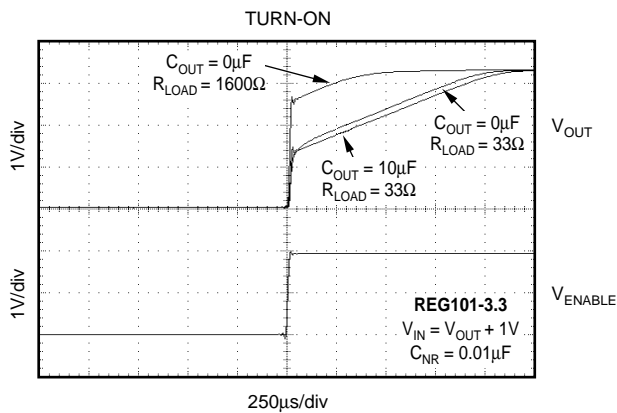
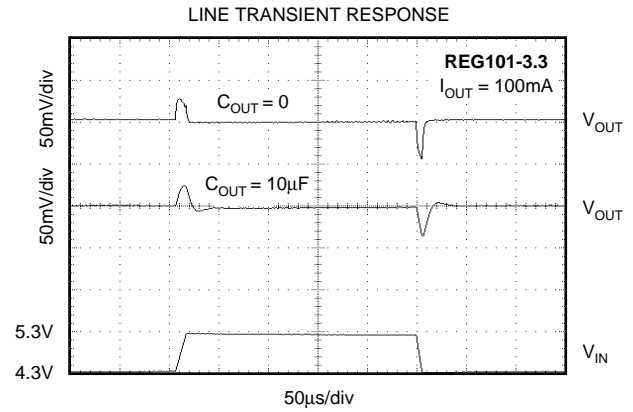
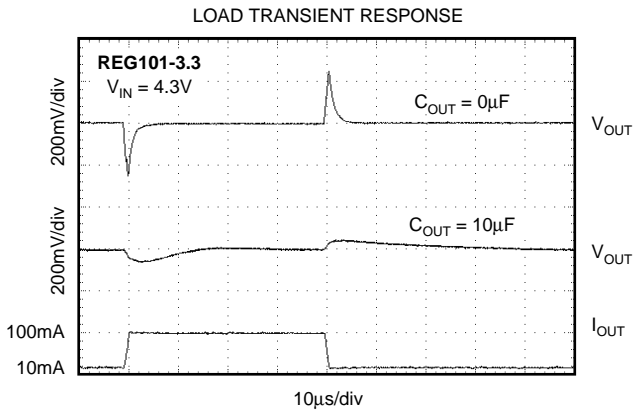
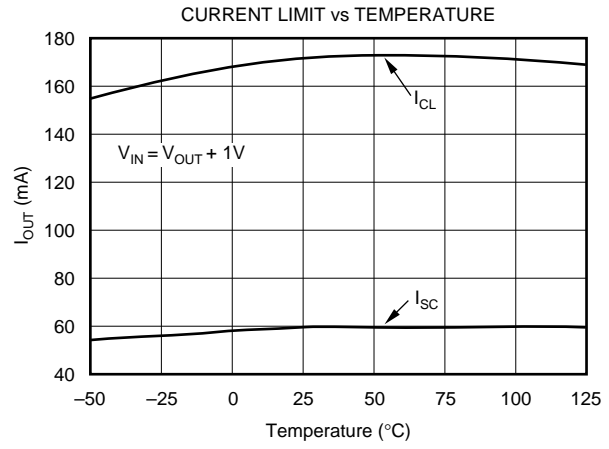
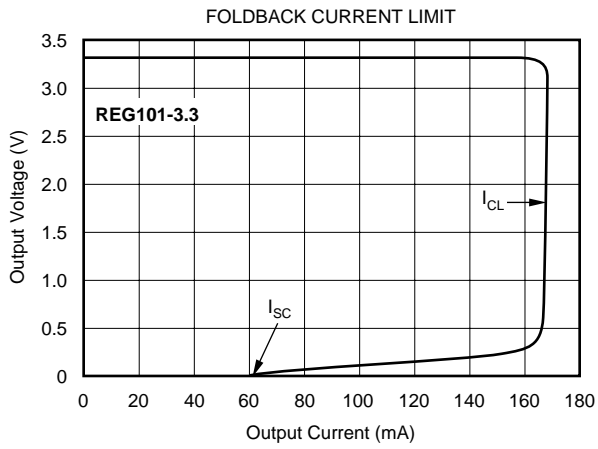

TYPICAL CHARACTERISTICS (Cont.)

For all models, at $T_J = +25^\circ\text{C}$ and $V_{\text{ENABLE}} = 1.8\text{V}$, unless otherwise noted.

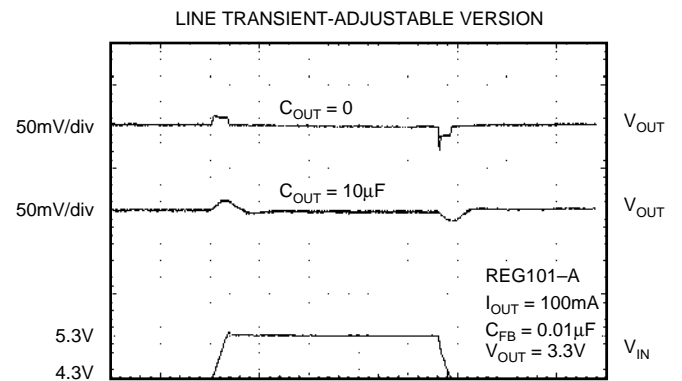
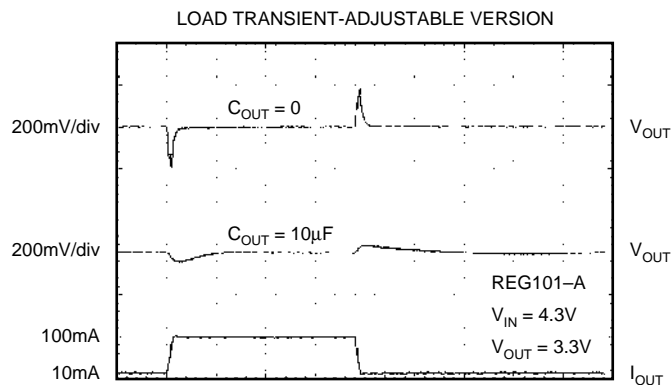
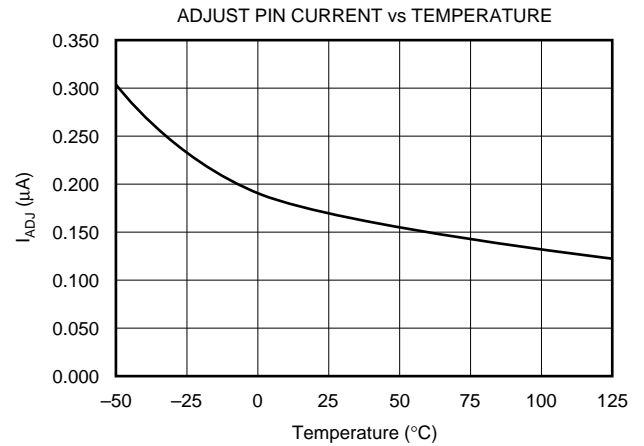
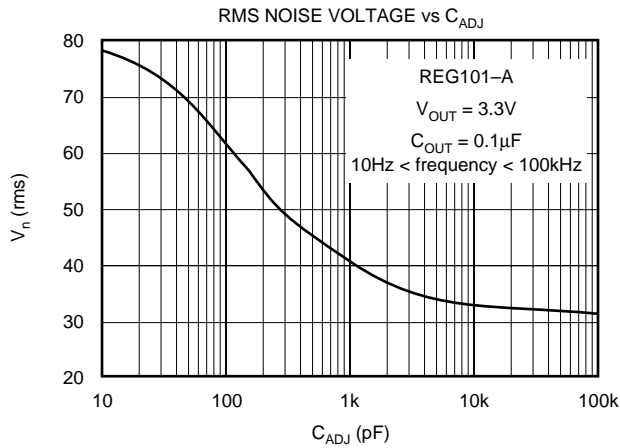
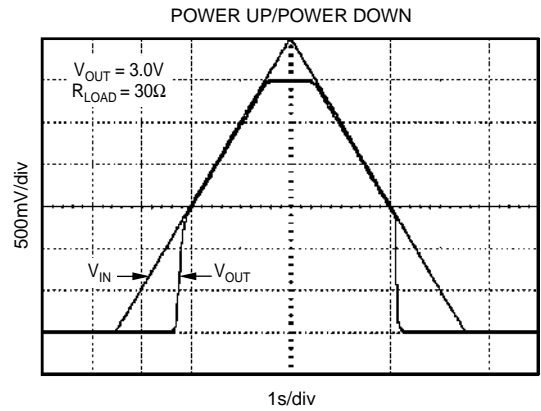
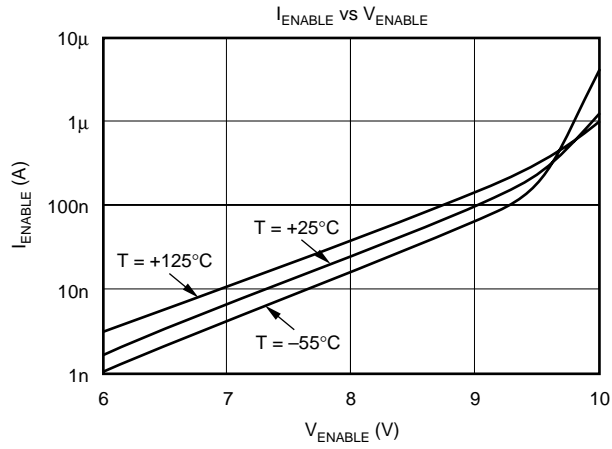

BASIC OPERATION

The REG101 series of LDO (Low Drop-Out) linear regulators offers a wide selection of fixed output voltage versions and an adjustable output version. The REG101 belongs to a family of new generation LDO regulators that utilize a DMOS pass transistor to achieve ultra-low dropout performance and freedom from output capacitor constraints. Ground pin current remains under 650µA over all line, load, and temperature conditions. All versions have thermal and over-current protection, including foldback current limit.

The REG101 does not require an output capacitor for regulator stability and is stable over most output currents and with almost any value and type of output capacitor up to 10µF or more. For applications where the regulator output current drops below several milliamps, stability can be enhanced by: adding a 1kΩ to 2kΩ load resistor; using capacitance values less than 10µF; or keeping the effective series resistance greater than 0.05Ω including the capacitor's ESR and parasitic resistance in printed circuit board traces, solder joints, and sockets.

Although an input capacitor is not required, it is good analog design practice to connect a 0.1µF low ESR capacitor across

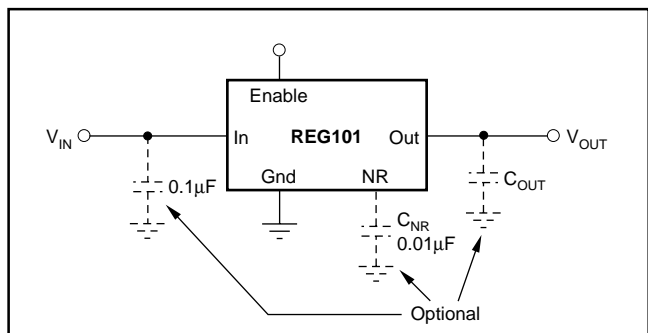

FIGURE 1. Fixed Voltage Nominal Circuit for REG101.

the input supply voltage. This is recommended to improve ripple rejection by reducing input voltage ripple.

Figure 1 shows the basic circuit connections for the fixed voltage models. Figure 2 gives the connections for the adjustable output version (REG101A) and example resistor values for some commonly used output voltages. Values for other voltages can be calculated from the equation shown in Figure 2.

INTERNAL CURRENT LIMIT

The REG101 internal current limit has a typical value of 170mA. A foldback feature limits the short-circuit current to a typical short-circuit value of 60mA. This helps to protect the regulator from damage under all load conditions. A characteristic of V_{OUT} versus I_{OUT} is given in Figure 3 and in the Typical Characteristics section.

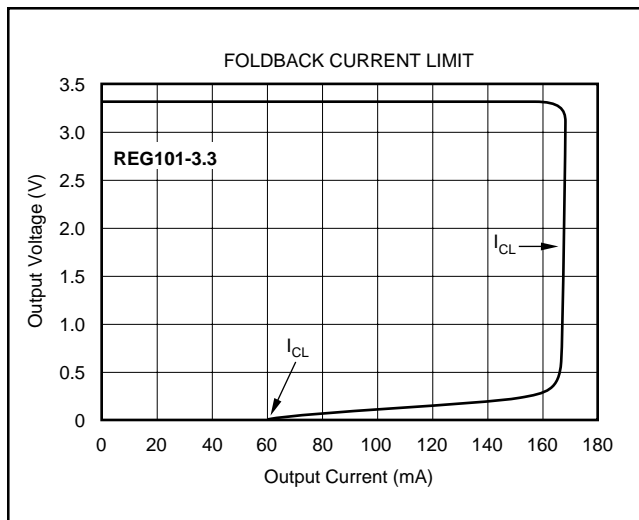

FIGURE 3. Foldback Current Limit of the REG101-3.3 at 25°C.

Pin numbers for SOT23 package.

$$V_{OUT} = (1 + R_1/R_2) \cdot 1.267V$$

To reduce current through divider, increase resistor values (see table at right).
As the impedance of the resistor divider increases, I_{ADJ} (~200nA) may introduce an error.
C_{FB} improves noise and transient response.

EXAMPLE RESISTOR VALUES		
V _{OUT} (V)	R ₁ (W) ⁽¹⁾	R ₂ (Ω) ⁽¹⁾
2.5	11.3k 1.13k	11.5k 1.15k
3.0	15.8k 1.58k	11.5k 1.15k
3.3	18.7k 1.87k	11.5k 1.15k
5.0	34.0k 3.40k	11.5k 1.15k

NOTE: (1) Resistors are standard 1% values.

FIGURE 2. Adjustable Voltage Circuit for REG101A.

ENABLE

The Enable pin is active HIGH and compatible with standard TTL-CMOS levels. Inputs below 0.5V (max) turn the regulator off and all circuitry is disabled. Under this condition, ground pin current drops to approximately 10nA. When a pull-up resistor is used, and operation down to $V_{IN} = 1.8V$ is required, use values $< 50k\Omega$.

OUTPUT NOISE

A precision band-gap reference is used for the internal reference voltage, V_{REF} . This reference is the dominant noise source within the REG101 and it generates approximately $29\mu V_{rms}$ in the 10Hz to 100kHz bandwidth at the reference output. The regulator control loop gains up the reference noise, so that the noise voltage of the regulator is approximately given by:

$$V_N = 29\mu V_{rms} \frac{R_1 + R_2}{R_2} = 29\mu V_{rms} \cdot \frac{V_{OUT}}{V_{REF}}$$

Since the value of V_{REF} is 1.267V, this relationship reduces to:

$$V_N = 23 \frac{\mu V_{rms}}{V} \cdot V_{OUT}$$

Connecting a capacitor, C_{NR} , from the Noise Reduction (NR) pin to ground, as shown in Figure 4, forms a low-pass filter for the voltage reference. For $C_{NR} = 10nF$, the total noise in the 10Hz to 100kHz bandwidth is reduced by approximately a factor of 2.8 for $V_O = 3.3V$. This noise reduction effect is shown in Figure 5 and as "RMS Noise Voltage vs CNR" in the Typical Characteristics section.

Noise can be further reduced by carefully choosing an output capacitor, C_{OUT} . Best overall noise performance is

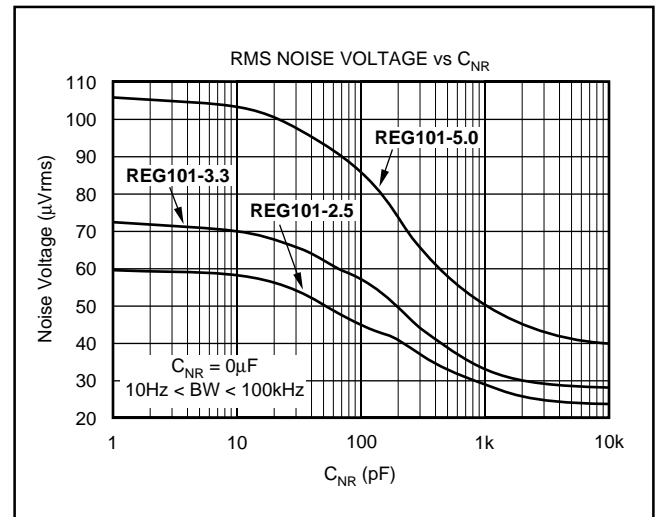

FIGURE 5. Output Noise versus Noise Reduction Capacitor.

achieved with very low ($< 0.22\mu F$) or very high ($> 2.2\mu F$) values of C_{OUT} . See "RMS Noise Voltage vs C_{OUT} " in the Typical Characteristics section.

The REG101 utilizes an internal charge pump to develop an internal supply voltage sufficient to drive the gate of the DMOS pass element above V_{IN} . The charge-pump switching noise (nominal switching frequency = 2MHz) is not measurable at the output of the regulator over most values of C_{OUT} and I_{OUT} .

The REG101 adjustable version does not have the noise-reduction pin available, however, the adjust pin is the summing junction of the error amplifier. A capacitor, C_{FB} , connected from the output to the adjust pin will reduce both the output noise and the peak error from a load transient. See the typical characteristics for output noise performance.

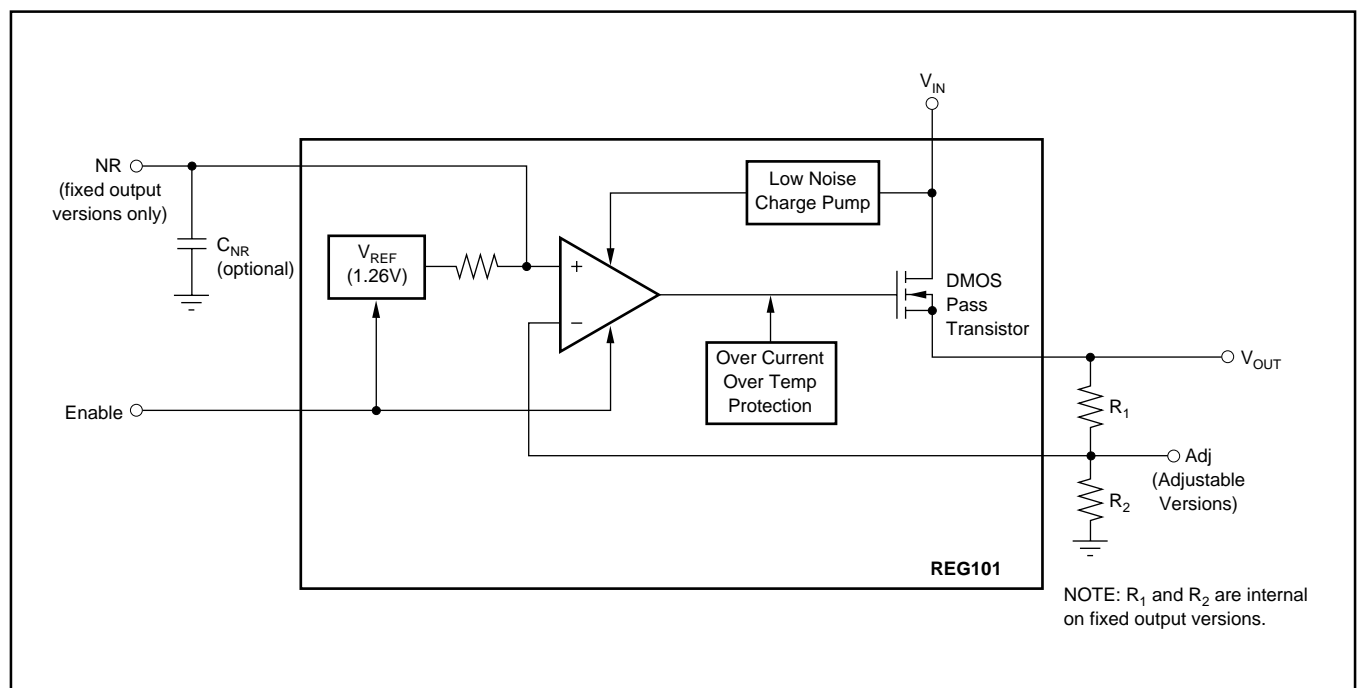

FIGURE 4. Block Diagram.

DROP-OUT VOLTAGE

The REG101 uses an N-channel DMOS as the “pass” element. When the input voltage is within a few tens of millivolts of the output voltage, the DMOS device behaves like a resistor. Therefore, for low values of V_{IN} to V_{OUT} , the regulator’s input-to-output resistance is the R_{dsON} of the DMOS pass element (typically $600m\Omega$). For static (DC) loads, the REG101 will typically maintain regulation down to V_{IN} to V_{OUT} voltage drop of $60mV$ at full rated output current. In Figure 6, the bottom line (DC dropout) shows the minimum V_{IN} to V_{OUT} voltage drop required to prevent drop-out under DC load conditions.

For large step changes in load current, the REG101 requires a larger voltage drop across it to avoid degraded transient response. The boundary of this “transient drop-out” region is shown as the top line in Figure 6. Values of V_{IN} to V_{OUT} voltage drop above this line insure normal transient response.

In the transient dropout region between “DC” and “Transient”, transient response recovery time increases. The time required to recover from a load transient is a function of both the magnitude and rate of the step change in load current and the available “headroom” V_{IN} to V_{OUT} voltage drop. Under worst-case conditions (full-scale load change with V_{IN} to V_{OUT} voltage drop close to DC dropout levels), the REG101 can take several hundred microseconds to re-enter the specified window of regulation.

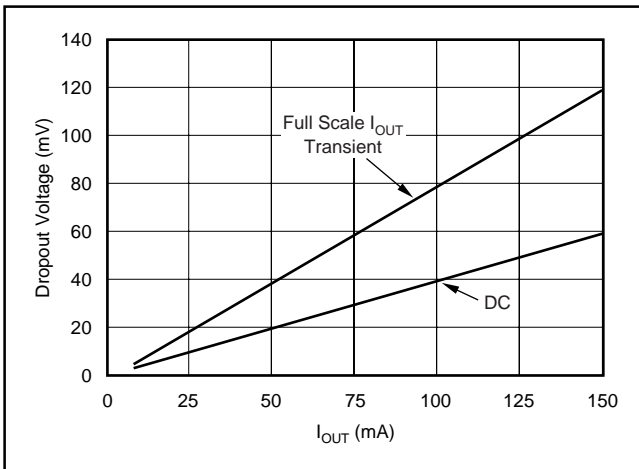

FIGURE 6. Transient and DC Dropout.

TRANSIENT RESPONSE

The REG101 response to transient line and load conditions improves at lower output voltages. The addition of a capacitor (nominal value $0.47\mu F$) from the output pin to ground may improve the transient response. In the adjustable version, the addition of a capacitor, C_{FB} (nominal value $10nF$), from the output to the adjust pin will also improve the transient response.

THERMAL PROTECTION

The REG101 has thermal shutdown circuitry that protects the regulator from damage. The thermal protection circuitry disables the output when the junction temperature reaches approximately $160^{\circ}C$, allowing the device to cool. When the junction temperature cools to approximately $140^{\circ}C$, the output circuitry is again enabled. Depending on various conditions, the thermal protection circuit may cycle on and off. This limits the dissipation of the regulator, but may have an undesirable effect on the load.

Any tendency to activate the thermal protection circuit indicates excessive power dissipation or an inadequate heat sink. For reliable operation, junction temperature should be limited to $125^{\circ}C$, maximum. To estimate the margin of safety in a complete design (including heat sink), increase the ambient temperature until the thermal protection is triggered. Use worst-case loads and signal conditions. For good reliability, thermal protection should trigger more than $35^{\circ}C$ above the maximum expected ambient condition of your application. This produces a worst-case junction temperature of $125^{\circ}C$ at the highest expected ambient temperature and worst-case load.

The internal protection circuitry of the REG101 has been designed to protect against overload conditions. It was not intended to replace proper heat sinking. Continuously running the REG101 into thermal shutdown will degrade reliability.

POWER DISSIPATION

The REG101 is available in two different package configurations. The ability to remove heat from the die is different for each package type and, therefore, presents different considerations in the printed circuit-board layout. The PCB area around the device that is free of other components moves the heat from the device to the ambient air. While it is difficult-to-impossible to quantify all of the variables in a thermal design of this type, performance data for several configurations are shown in Figure 7.

Power dissipation depends on input voltage, load condition, and duty cycle. Power dissipation is equal to the product of the average output current times the voltage across the output element, V_{IN} to V_{OUT} voltage drop.

$$P_D = (V_{IN} - V_{OUT}) \cdot I_{OUT(AVG)}$$

Power dissipation can be minimized by using the lowest possible input voltage necessary to assure the required output voltage.

REGULATOR MOUNTING

Solder pad footprint recommendations for the various REG101 devices are presented in the Application Bulletin AB-132, "Solder Pad Recommendations for Surface-Mount Devices" (SBFA015), available from the Texas Instruments web site (www.ti.com).

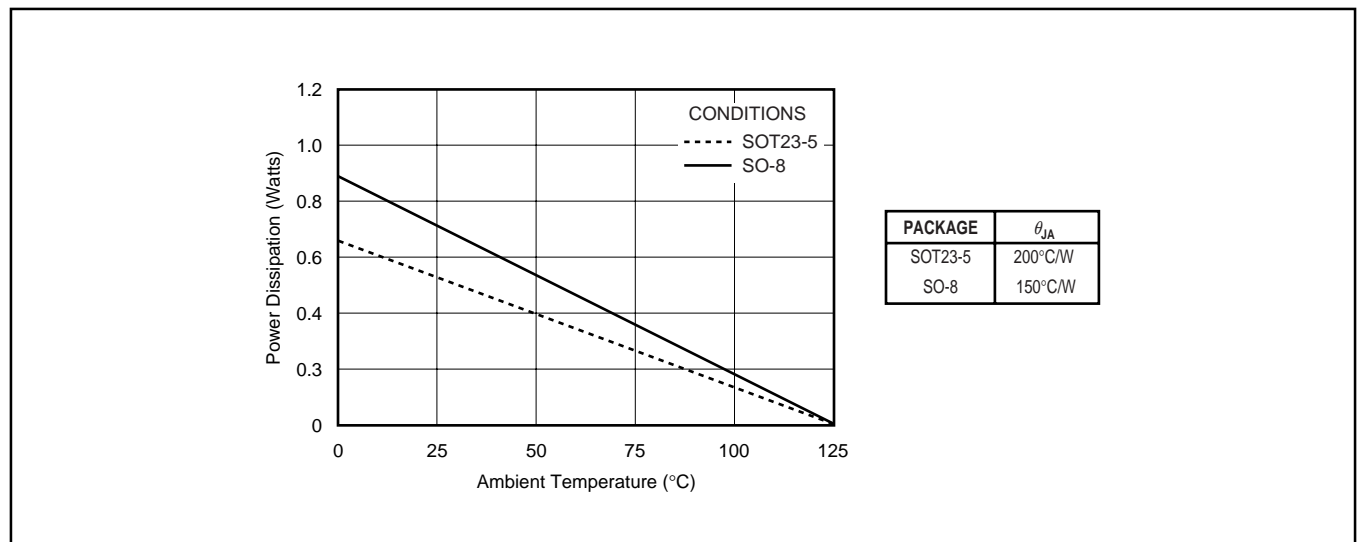

FIGURE 7. Maximum Power Dissipation versus Ambient Temperature for the Various Packages.

PACKAGING INFORMATION

ORDERABLE DEVICE	STATUS(1)	PACKAGE TYPE	PACKAGE DRAWING	PINS	PACKAGE QTY
REG101NA-2.5/250	ACTIVE	SOP	DBV	5	250
REG101NA-2.5/3K	ACTIVE	SOP	DBV	5	3000
REG101NA-2.8/250	ACTIVE	SOP	DBV	5	250
REG101NA-2.8/3K	ACTIVE	SOP	DBV	5	3000
REG101NA-2.85/250	ACTIVE	SOP	DBV	5	250
REG101NA-2.85/3K	ACTIVE	SOP	DBV	5	3000
REG101NA-3.3/250	ACTIVE	SOP	DBV	5	250
REG101NA-3.3/3K	ACTIVE	SOP	DBV	5	3000
REG101NA-3/250	ACTIVE	SOP	DBV	5	250
REG101NA-3/3K	ACTIVE	SOP	DBV	5	3000
REG101NA-5/250	ACTIVE	SOP	DBV	5	250
REG101NA-5/3K	ACTIVE	SOP	DBV	5	3000
REG101NA-A/250	ACTIVE	SOP	DBV	5	250
REG101NA-A/3K	ACTIVE	SOP	DBV	5	3000
REG101UA-2.5	ACTIVE	SOIC	D	8	100
REG101UA-2.5/2K5	ACTIVE	SOIC	D	8	2500
REG101UA-2.8	ACTIVE	SOIC	D	8	100
REG101UA-2.8/2K5	ACTIVE	SOIC	D	8	2500
REG101UA-2.85	ACTIVE	SOIC	D	8	100
REG101UA-2.85/2K5	ACTIVE	SOIC	D	8	2500
REG101UA-3	ACTIVE	SOIC	D	8	100
REG101UA-3.3	ACTIVE	SOIC	D	8	100
REG101UA-3.3/2K5	ACTIVE	SOIC	D	8	2500
REG101UA-3/2K5	ACTIVE	SOIC	D	8	2500
REG101UA-5	ACTIVE	SOIC	D	8	100
REG101UA-5/2K5	ACTIVE	SOIC	D	8	2500
REG101UA-A	ACTIVE	SOIC	D	8	100
REG101UA-A/2K5	ACTIVE	SOIC	D	8	2500

(1) The marketing status values are defined as follows:

ACTIVE: Product device recommended for new designs.

LIFEBUY: TI has announced that the device will be discontinued, and a lifetime-buy period is in effect.

NRND: Not recommended for new designs. Device is in production to support existing customers, but TI does not recommend using this part in a new design.

PREVIEW: Device has been announced but is not in production. Samples may or may not be available.

OBSOLETE: TI has discontinued the production of the device.

IMPORTANT NOTICE

Texas Instruments Incorporated and its subsidiaries (TI) reserve the right to make corrections, modifications, enhancements, improvements, and other changes to its products and services at any time and to discontinue any product or service without notice. Customers should obtain the latest relevant information before placing orders and should verify that such information is current and complete. All products are sold subject to TI's terms and conditions of sale supplied at the time of order acknowledgment.

TI warrants performance of its hardware products to the specifications applicable at the time of sale in accordance with TI's standard warranty. Testing and other quality control techniques are used to the extent TI deems necessary to support this warranty. Except where mandated by government requirements, testing of all parameters of each product is not necessarily performed.

TI assumes no liability for applications assistance or customer product design. Customers are responsible for their products and applications using TI components. To minimize the risks associated with customer products and applications, customers should provide adequate design and operating safeguards.

TI does not warrant or represent that any license, either express or implied, is granted under any TI patent right, copyright, mask work right, or other TI intellectual property right relating to any combination, machine, or process in which TI products or services are used. Information published by TI regarding third-party products or services does not constitute a license from TI to use such products or services or a warranty or endorsement thereof. Use of such information may require a license from a third party under the patents or other intellectual property of the third party, or a license from TI under the patents or other intellectual property of TI.

Reproduction of information in TI data books or data sheets is permissible only if reproduction is without alteration and is accompanied by all associated warranties, conditions, limitations, and notices. Reproduction of this information with alteration is an unfair and deceptive business practice. TI is not responsible or liable for such altered documentation.

Resale of TI products or services with statements different from or beyond the parameters stated by TI for that product or service voids all express and any implied warranties for the associated TI product or service and is an unfair and deceptive business practice. TI is not responsible or liable for any such statements.

Following are URLs where you can obtain information on other Texas Instruments products and application solutions:

Products		Applications	
Amplifiers	amplifier.ti.com	Audio	www.ti.com/audio
Data Converters	dataconverter.ti.com	Automotive	www.ti.com/automotive
DSP	dsp.ti.com	Broadband	www.ti.com/broadband
Interface	interface.ti.com	Digital Control	www.ti.com/digitalcontrol
Logic	logic.ti.com	Military	www.ti.com/military
Power Mgmt	power.ti.com	Optical Networking	www.ti.com/opticalnetwork
Microcontrollers	microcontroller.ti.com	Security	www.ti.com/security
		Telephony	www.ti.com/telephony
		Video & Imaging	www.ti.com/video
		Wireless	www.ti.com/wireless

Mailing Address: Texas Instruments
Post Office Box 655303 Dallas, Texas 75265