

International IR Rectifier

IRGMC30U

INSULATED GATE BIPOLAR TRANSISTOR

Ultra Fast Speed IGBT

Features

- Electrically Isolated and Hermetically Sealed
- Simple Drive Requirements
- Latch-proof
- Fast Speed operation > 10 kHz
- Switching-loss rating includes all "tail" losses

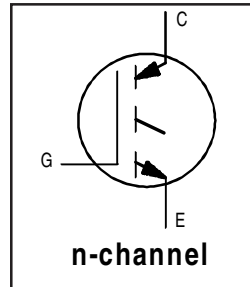

$V_{CES} = 600V$
$V_{CE(on) max} = 3.0V$
@ $V_{GE} = 15V, I_C = 8.0A$

Description

Insulated Gate Bipolar Transistors (IGBTs) from International Rectifier have higher usable current densities than comparable bipolar transistors, while at the same time having simpler gate-drive requirements of the familiar power MOSFET. They provide substantial benefits to a host of high-voltage, high-current applications.

The performance of various IGBTs varies greatly with frequency. Note that IR now provides the designer with a speed benchmark ($f_{IC/2}$, or the "half-current frequency"), as well as an indication of the current handling capability of the device.

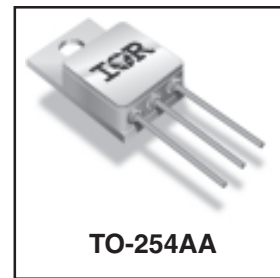

Absolute Maximum Ratings

	Parameter	Max.	Units
V_{CES}	Collector-to-Emitter Breakdown Voltage	600	V
$I_C @ T_C = 25^\circ C$	Continuous Collector Current	17	A
$I_C @ T_C = 100^\circ C$	Continuous Collector Current	8.0	
I_{CM}	Pulsed Collector Current ①	68	
I_{LM}	Clamped Inductive Load Current ②	68	
V_{GE}	Gate-to-Emitter Voltage	± 20	V
$P_D @ T_C = 25^\circ C$	Maximum Power Dissipation	75	W
$P_D @ T_C = 100^\circ C$	Maximum Power Dissipation	30	
T_J	Operating Junction and Storage Temperature Range	-55 to + 150	°C
T_{STG}			
	Lead Temperature	300 (0.063in./1.6mm from case for 10s)	
	Weight	9.3 (typical)	g

Thermal Resistance

	Parameter	Min	Typ	Max	Units	Test Conditions
R_{thJC}	Junction-to-Case	—	—	1.67	°C/W	
R_{thCS}	Case-to-Sink	—	0.21	—		
R_{thJA}	Junction-to-Ambient	—	—	48		

For footnotes refer to the last page
www.irf.com

Electrical Characteristics @ $T_J = 25^\circ\text{C}$ (unless otherwise specified)

	Parameter	Min.	Typ.	Max.	Units	Conditions
$V_{(BR)CES}$	Collector-to-Emitter Breakdown Voltage	600	—	—	V	$V_{GE} = 0V, I_C = 1.0\text{ mA}$
$V_{(BR)ECS}$	Emitter-to-Collector Breakdown Voltage ③	15	—	—	V	$V_{GE} = 0V, I_C = 1.0\text{ A}$
$\Delta V_{(BR)CES}/\Delta T_J$	Temperature Coeff. of Breakdown Voltage	—	0.63	—	$V/^\circ\text{C}$	$V_{GE} = 0V, I_C = 1.0\text{ mA}$
$V_{CE(ON)}$	Collector-to-Emitter Saturation Voltage	—	—	3.0	V	$I_C = 8.0\text{ A}$ $V_{GE} = 15\text{ V}$
		—	2.7	—		$I_C = 17\text{ A}$ See Fig.5
		—	2.4	—		$I_C = 8.0\text{ A}, T_J = 125^\circ\text{C}$
$V_{GE(th)}$	Gate Threshold Voltage	3.0	—	5.5		$V_{CE} = V_{GE}, I_C = 250\ \mu\text{A}$
$\Delta V_{GE(th)}/\Delta T_J$	Temperature Coeff. of Threshold Voltage	—	-11	—	$\text{mV}/^\circ\text{C}$	$V_{CE} = V_{GE}, I_C = 250\ \mu\text{A}$
g_{fe}	Forward Transconductance ④	3.1	—	—	S	$V_{CE} \geq 15\text{ V}, I_C = 8.0\text{ A}$
I_{CES}	Zero Gate Voltage Collector Current	—	—	50	μA	$V_{GE} = 0V, V_{CE} = 480\text{ V}$
		—	—	1000		$V_{GE} = 0V, V_{CE} = 480\text{ V}, T_J = 125^\circ\text{C}$
I_{GES}	Gate-to-Emitter Leakage Current	—	—	± 500	nA	$V_{GE} = \pm 20\text{ V}$

Switching Characteristics @ $T_J = 25^\circ\text{C}$ (unless otherwise specified)

	Parameter	Min.	Typ.	Max.	Units	Conditions
Q_g	Total Gate Charge (turn-on)	—	28	56	nC	$I_C = 8.0\text{ A}$
Q_{ge}	Gate - Emitter Charge (turn-on)	—	5.0	10		$V_{CC} = 300\text{ V}$ See Fig. 8
Q_{gc}	Gate - Collector Charge (turn-on)	—	12	24		$V_{GE} = 15\text{ V}$
$t_{d(on)}$	Turn-On Delay Time	—	—	48	ns	$I_C = 8.0\text{ A}, V_{CC} = 480\text{ V}$
t_r	Rise Time	—	—	30		$V_{GE} = 15\text{ V}, R_G = 7.5\ \Omega$
$t_{d(off)}$	Turn-Off Delay Time	—	—	200		Energy losses include "tail"
t_f	Fall Time	—	—	190		See Fig. 9, 10, 13
E_{on}	Turn-On Switching Loss	—	0.18	—		mJ
E_{off}	Turn-off Switching Loss	—	0.41	—		
E_{ts}	Total Switching Loss	—	0.59	1.2		
$t_{d(on)}$	Turn-On Delay Time	—	24	—	ns	$T_J = 125^\circ\text{C}$
t_r	Rise Time	—	15	—		$I_C = 8.0\text{ A}, V_{CC} = 480\text{ V}$
$t_{d(off)}$	Turn-Off Delay Time	—	160	—		$V_{GE} = 15\text{ V}, R_G = 7.5\ \Omega$
t_f	Fall Time	—	200	—		Energy losses include "tail"
E_{ts}	Total Switching Loss	—	1.2	—		See Fig. 11, 13
L_C+L_E	Total Inductance	—	6.8	—	nH	Measured from Collector lead (6mm/0.25in. from package) to Emitter lead (6mm / 0.25in. from package)
C_{ies}	Input Capacitance	—	660	—	pF	$V_{GE} = 0\text{ V}$
C_{oes}	Output Capacitance	—	100	—		$V_{CC} = 30\text{ V}$ See Fig. 7
C_{res}	Reverse Transfer Capacitance	—	11	—		$f = 1.0\text{ MHz}$

Note: Corresponding Spice and Saber models are available on the Website.

For footnotes refer to the last page

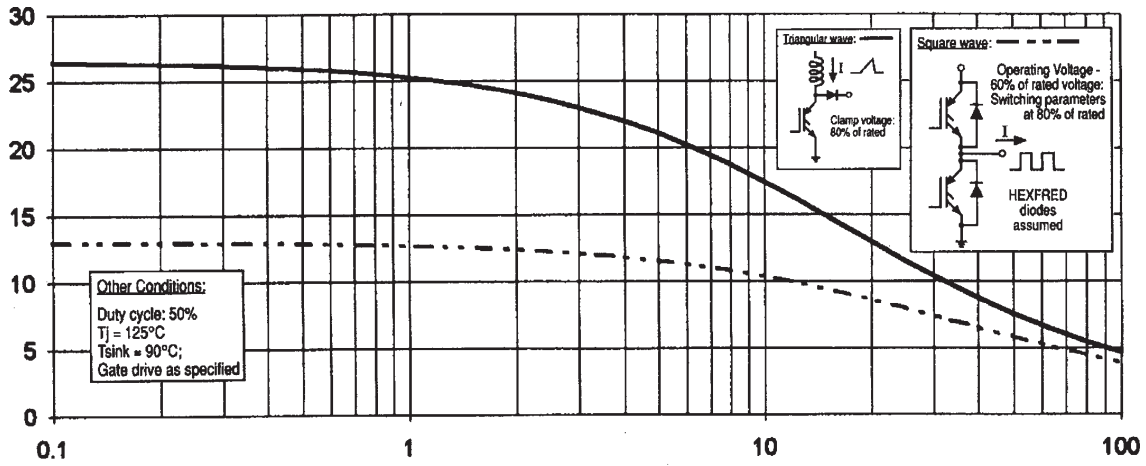

Fig. 1 - Typical Load Current vs. Frequency
(For square wave, $I = I_{RMS}$ of fundamental; for triangular wave, $I = I_{PK}$)

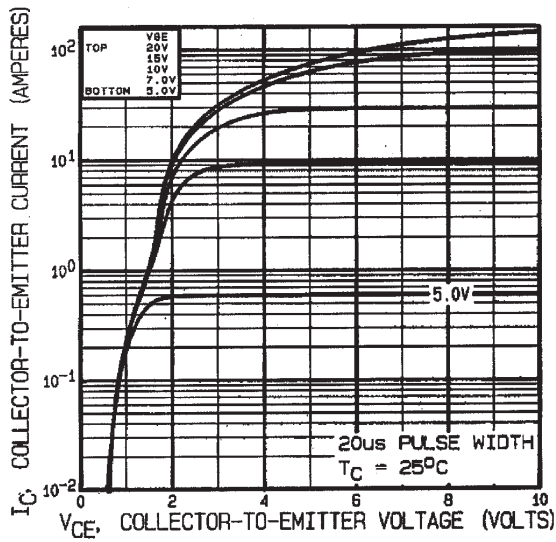

Fig. 2 - Typical Output Characteristics

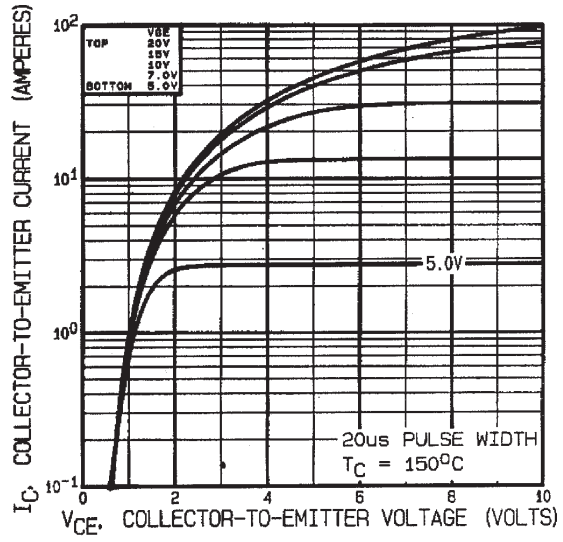

Fig. 3 - Typical Transfer Characteristics

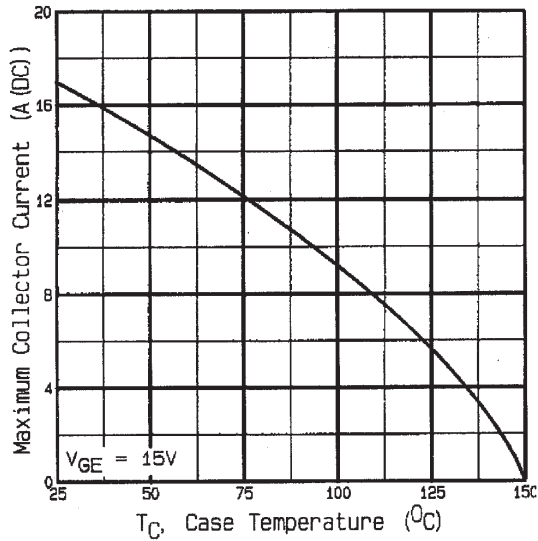

Fig. 4 - Maximum Collector Current vs. Case Temperature

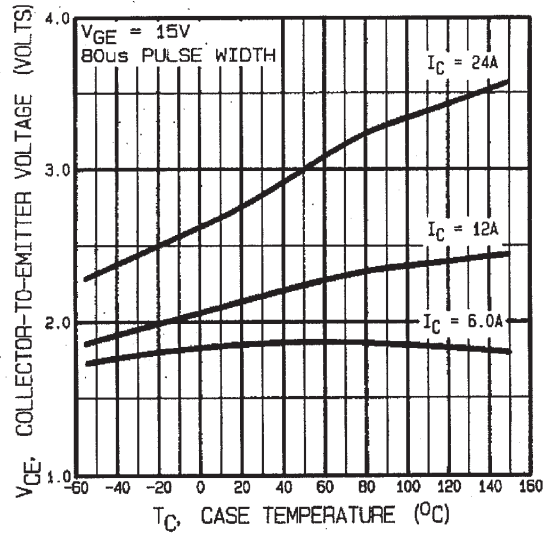

Fig. 5 - Collector-to-Emitter Voltage vs. Junction Temperature

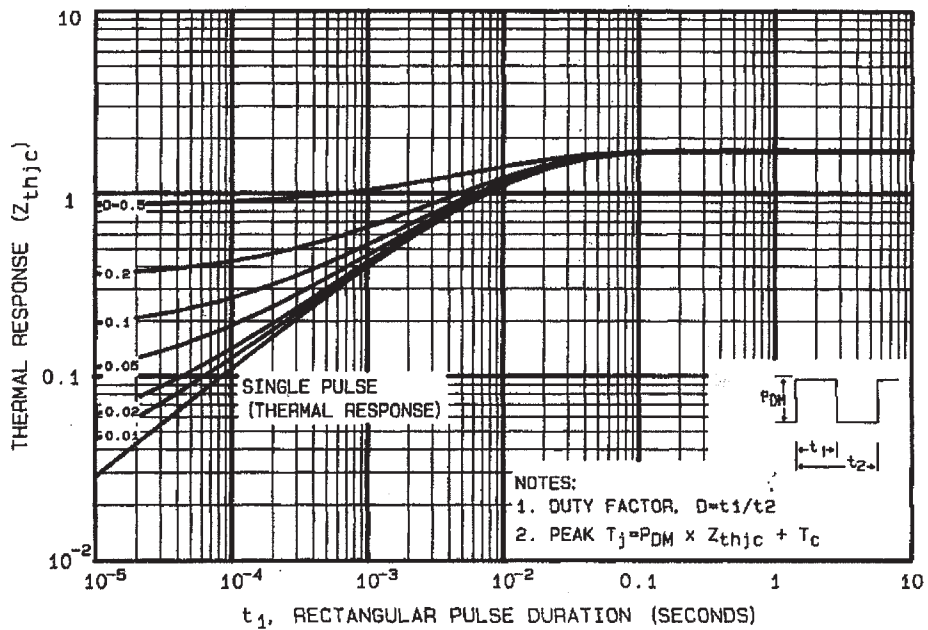

Fig. 6 - Maximum Effective Transient Thermal Impedance, Junction-to-Case

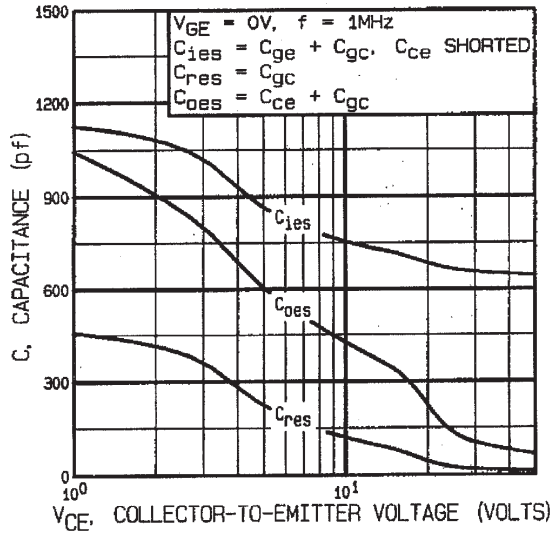

Fig. 7 - Typical Capacitance vs. Collector-to-Emitter Voltage

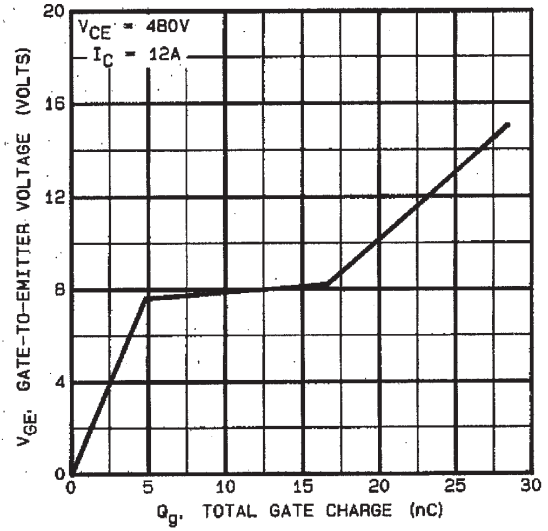

Fig. 8 - Typical Gate Charge vs. Gate-to-Emitter Voltage

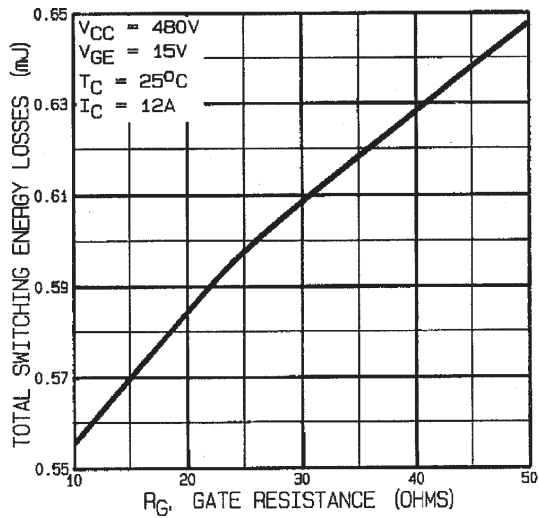

Fig. 9 - Typical Switching Losses vs. Gate Resistance

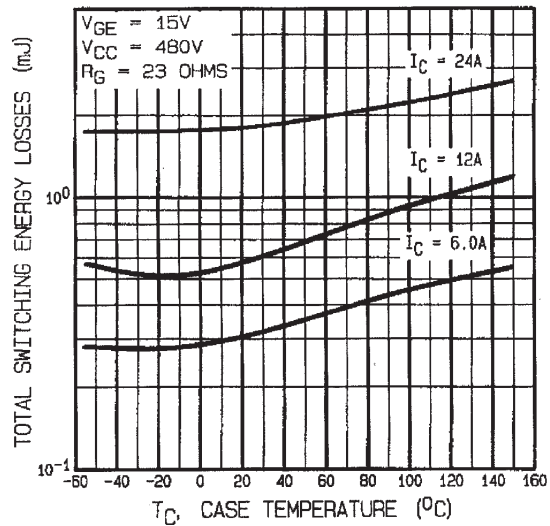

Fig. 10 - Typical Switching Losses vs. Junction Temperature

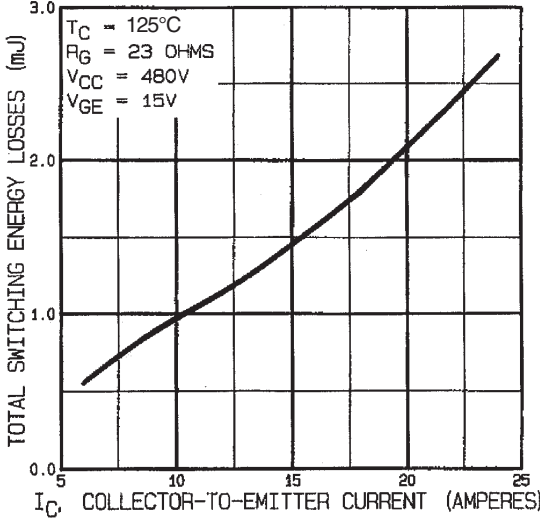

Fig. 11 - Typical Switching Losses vs. Collector-to-Emitter Current

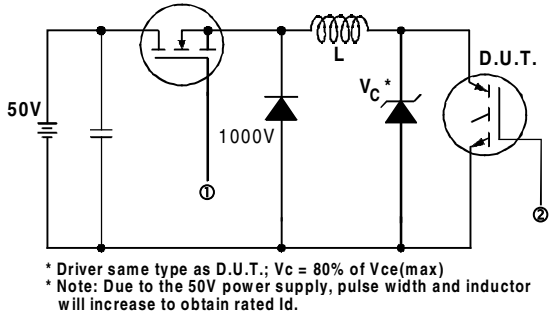

Fig. 12a - Clamped Inductive Load Test Circuit

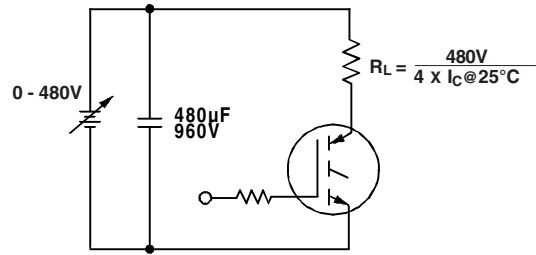

Fig. 12b - Pulsed Collector Current Test Circuit

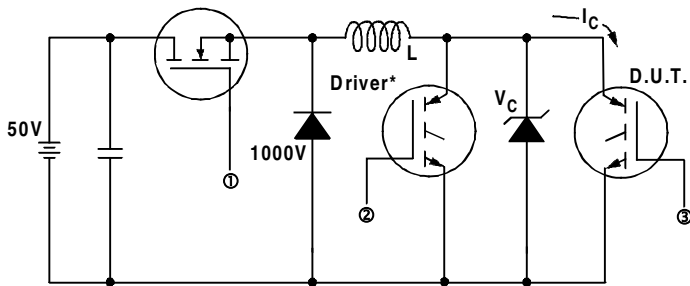

Fig. 13a - Switching Loss Test Circuit

* Driver same type as D.U.T., $V_C = 480V$

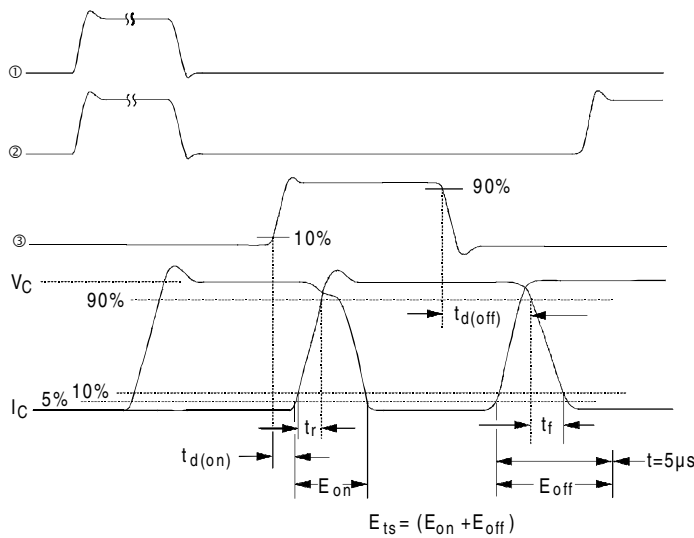

Fig. 13b - Switching Loss Waveforms

IRGMC30U

International
IR Rectifier

Notes:

- ① Repetitive rating; $V_{GE} = 20V$, pulse width limited by max. junction temperature.
- ② $V_{CC} = 80\%(V_{CES})$, $V_{GE} = 20V$, $L = 10\mu H$, $R_G = 10\Omega$
- ③ Pulse width $\leq 80\mu s$; duty factor $\leq 0.1\%$.
- ④ Pulse width $5.0\mu s$, single shot.

Case Outline and Dimensions — TO-254AA

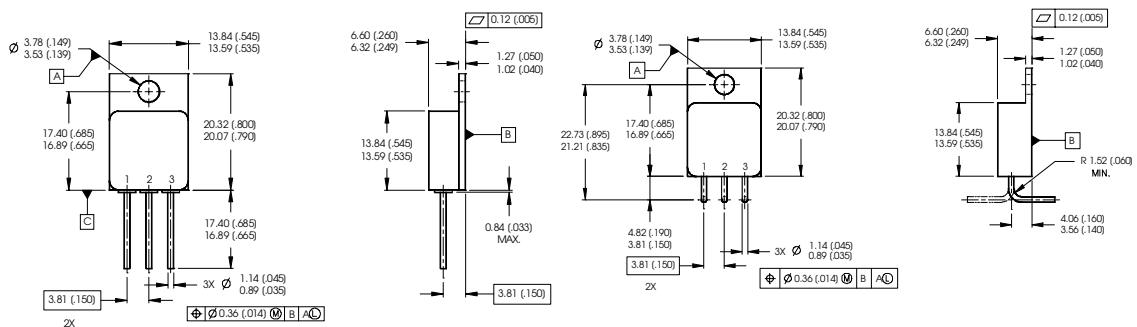

NOTES:

1. DIMENSIONING & TOLERANCING PER ASME Y14.5M-1994.
2. ALL DIMENSIONS ARE SHOWN IN MILLIMETERS (INCHES).
3. CONTROLLING DIMENSION: INCH.
4. CONFORMS TO JEDEC OUTLINE TO-254AA.

LEGEND

- 1 = COLLECTOR
- 2 = EMITTER
- 3 = GATE

CAUTION

BERYLLIA WARNING PER MIL-PRF-19500

Packages containing beryllia shall not be ground, sandblasted, machined or have other operations performed on them which will produce beryllia or beryllium dust. Furthermore, beryllium oxide packages shall not be placed in acids that will produce fumes containing beryllium.

International
IR Rectifier

IR WORLD HEADQUARTERS: 233 Kansas St., El Segundo, California 90245, USA Tel: (310) 252-7105
TAC Fax: (310) 252-7903

Visit us at www.irf.com for sales contact information.

Data and specifications subject to change without notice. 02/02

Copyright © Each Manufacturing Company.

All Datasheets cannot be modified without permission.

This datasheet has been download from :

www.AllDataSheet.com

100% Free DataSheet Search Site.

Free Download.

No Register.

Fast Search System.

www.AllDataSheet.com