



INSULATED GATE BIPOLAR TRANSISTOR

IRGB30B60K
IRGS30B60K
IRGSL30B60K

Features

- Low VCE (on) Non Punch Through IGBT Technology.
- 10µs Short Circuit Capability.
- Square RBSOA.
- Positive VCE (on) Temperature Coefficient.
- Maximum Junction Temperature rated at 175°C.

Benefits

- Benchmark Efficiency for Motor Control.
- Rugged Transient Performance.
- Low EMI.
- Excellent Current Sharing in Parallel Operation.

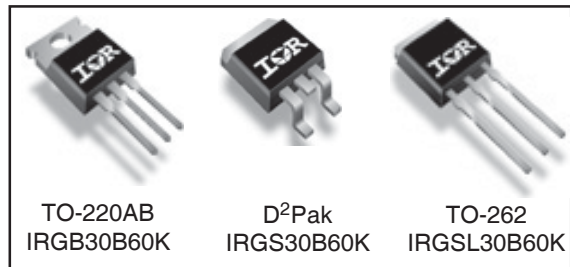
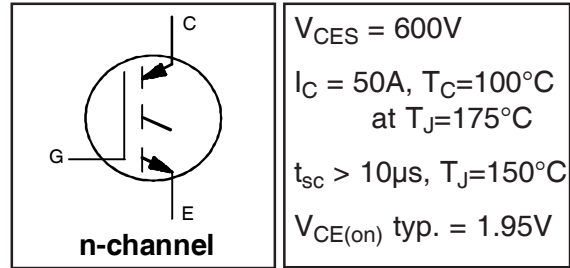

Absolute Maximum Ratings

	Parameter	Max.	Units
V_{CES}	Collector-to-Emitter Voltage	600	V
$I_C @ T_C = 25^\circ C$	Continuous Collector Current	78 ^⑤	A
$I_C @ T_C = 100^\circ C$	Continuous Collector Current	50	
I_{CM}	Pulse Collector Current (Ref.Fig.C.T.5)	120	
I_{LM}	Clamped Inductive Load current ①	120	
V_{ISOL}	RMS Isolation Voltage, Terminal to Case, t=1 min.	2500	V
V_{GE}	Gate-to-Emitter Voltage	±20	
$P_D @ T_C = 25^\circ C$	Maximum Power Dissipation	370	W
$P_D @ T_C = 100^\circ C$	Maximum Power Dissipation	180	
T_J	Operating Junction and	-55 to +175	°C
T_{STG}	Storage Temperature Range		
	Soldering Temperature, for 10 sec.	300 (0.063 in. (1.6mm) from case)	
	Mounting Torque, 6-32 or M3 Screw	10 lbf-in (1.1 N·m)	

Thermal / Mechanical Characteristics

	Parameter	Min.	Typ.	Max.	Units
$R_{\theta JC}$	Junction-to-Case- IGBT	—	—	0.41	°C/W
$R_{\theta CS}$	Case-to-Sink, flat, greased surface	—	0.50	—	
$R_{\theta JA}$	Junction-to-Ambient, typical socket mount ②	—	—	62	
$R_{\theta JA}$	Junction-to-Ambient (PCB Mount, Steady State) ③	—	—	40	
Wt	Weight	—	1.44	—	g

Electrical Characteristics @ T_J = 25°C (unless otherwise specified)

	Parameter	Min.	Typ.	Max.	Units	Conditions	Ref.Fig.
V _{(BR)CES}	Collector-to-Emitter Breakdown Voltage	600	—	—	V	V _{GE} = 0V, I _C = 500μA	
ΔV _{(BR)CES/ΔT_J}	Temperature Coeff. of Breakdown Voltage	—	0.40	—	V/°C	V _{GE} = 0V, I _C = 1mA (25°C-150°C)	
V _{CE(on)}	Collector-to-Emitter Voltage	—	1.95	2.35	V	I _C = 30A, V _{GE} = 15V, T _J = 25°C	5,6,7
		—	2.40	2.75		I _C = 30A, V _{GE} = 15V, T _J = 150°C	8,9,10
		—	2.6	2.95		I _C = 30A, V _{GE} = 15V, T _J = 175°C	
V _{GE(th)}	Gate Threshold Voltage	3.5	4.5	5.5	V	V _{CE} = V _{GE} , I _C = 250μA	8,9,10
ΔV _{GE(th)/ΔT_J}	Threshold Voltage temp. coefficient	—	-10	—	mV/°C	V _{CE} = V _{GE} , I _C = 1.0mA (25°C-150°C)	11
g _{fe}	Forward Transconductance	—	18	—	S	V _{CE} = 50V, I _C = 50A, PW = 80μs	
I _{CES}	Zero Gate Voltage Collector Current	—	5.0	250	μA	V _{GE} = 0V, V _{CE} = 600V	
		—	1000	2000		V _{GE} = 0V, V _{CE} = 600V, T _J = 150°C	
		—	1830	3000		V _{GE} = 0V, V _{CE} = 600V, T _J = 175°C	
I _{GES}	Gate-to-Emitter Leakage Current	—	—	±100	nA	V _{GE} = ±20V, V _{CE} = 0V	

Switching Characteristics @ T_J = 25°C (unless otherwise specified)

	Parameter	Min.	Typ.	Max.	Units	Conditions	Ref.Fig.
Q _g	Total Gate Charge (turn-on)	—	102	153	nC	I _C = 30A	17
Q _{ge}	Gate-to-Emitter Charge (turn-on)	—	14	21		V _{CC} = 400V	CT1
Q _{gc}	Gate-to-Collector Charge (turn-on)	—	44	66		V _{GE} = 15V	
E _{on}	Turn-On Switching Loss	—	350	620	μJ	I _C = 30A, V _{CC} = 400V	CT4
E _{off}	Turn-Off Switching Loss	—	825	955		V _{GE} = 15V, R _G = 10Ω, L = 200μH	
E _{tot}	Total Switching Loss	—	1175	1575		T _J = 25°C ⊕	
t _{d(on)}	Turn-On delay time	—	46	60	ns	I _C = 30A, V _{CC} = 400V	CT4
t _r	Rise time	—	28	39		V _{GE} = 15V, R _G = 10Ω, L = 200μH	
t _{d(off)}	Turn-Off delay time	—	185	200		T _J = 25°C	
t _f	Fall time	—	31	40			
E _{on}	Turn-On Switching Loss	—	635	1085		I _C = 30A, V _{CC} = 400V	
E _{off}	Turn-Off Switching Loss	—	1150	1350	μJ	V _{GE} = 15V, R _G = 10Ω, L = 200μH	12,14
E _{tot}	Total Switching Loss	—	1785	2435		T _J = 150°C ⊕	WF1,WF2
t _{d(on)}	Turn-On delay time	—	46	60		I _C = 30A, V _{CC} = 400V	13,15
t _r	Rise time	—	28	39	ns	V _{GE} = 15V, R _G = 10Ω, L = 200μH	CT4
t _{d(off)}	Turn-Off delay time	—	205	235		T _J = 150°C	WF1
t _f	Fall time	—	32	42			WF2
L _E	Internal Emitter Inductance	—	7.5	—	nH	Measured 5mm from package	
C _{ies}	Input Capacitance	—	1750	2500	pF	V _{GE} = 0V	16
C _{oes}	Output Capacitance	—	160	255		V _{CC} = 30V	
C _{res}	Reverse Transfer Capacitance	—	60	90		f = 1.0MHz	
RBSOA	Reverse Bias Safe Operating Area	FULL SQUARE				T _J = 150°C, I _C = 120A, V _p = 600V V _{CC} =500V, V _{GE} = +15V to 0V, R _G = 10Ω	4 CT2
SCSOA	Short Circuit Safe Operating Area	10	—	—	μs	T _J = 150°C, V _p = 600V, R _G = 10Ω V _{CC} =360V, V _{GE} = +15V to 0V	CT3 WF3
I _{SC (Peak)}	Peak Short Circuit Collector Current	—	200	—	A		WF3

Note ① to ⑤ are on page 13

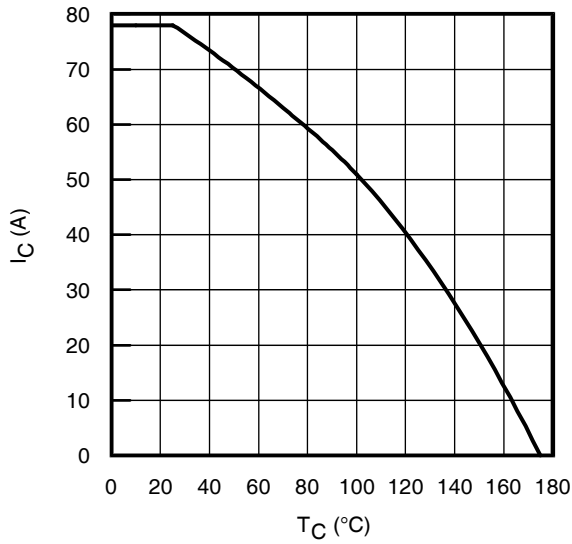

Fig. 1 - Maximum DC Collector Current vs. Case Temperature

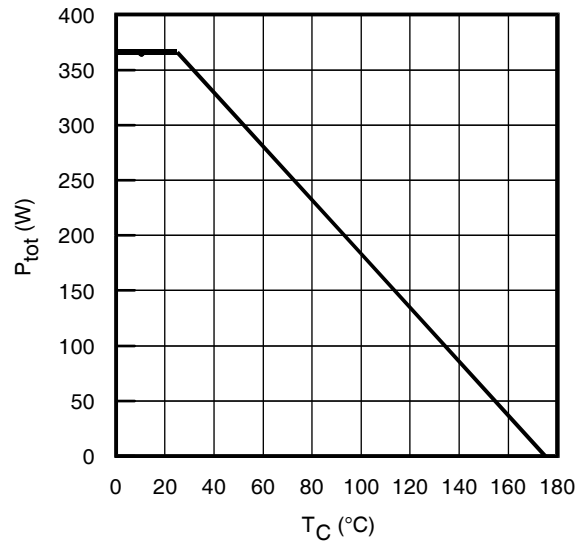

Fig. 2 - Power Dissipation vs. Case Temperature

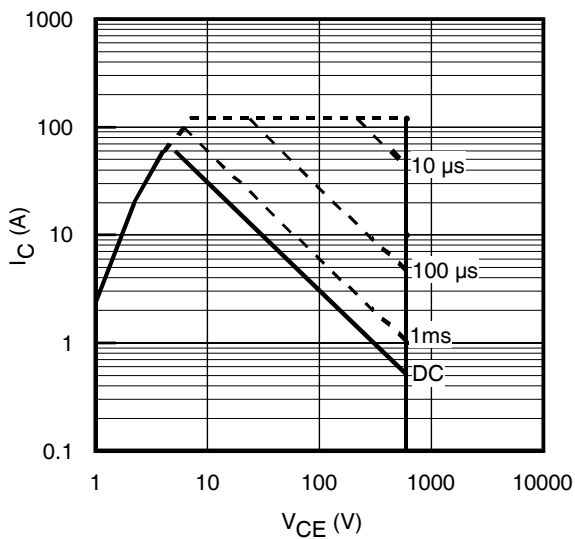

Fig. 3 - Forward SOA
 $T_C = 25^{\circ}C$; $T_J \leq 150^{\circ}C$

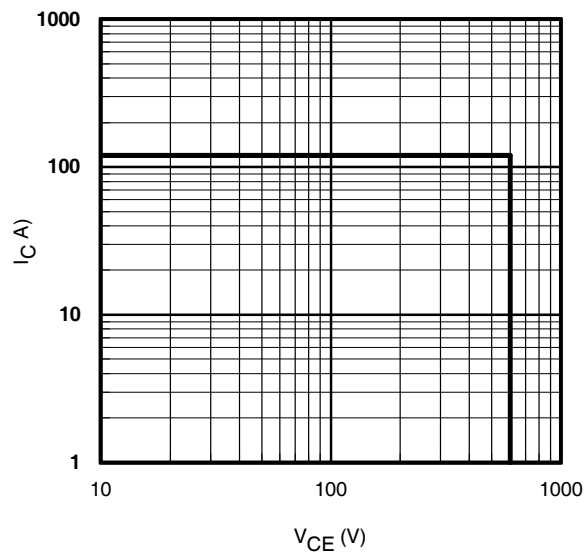

Fig. 4 - Reverse Bias SOA
 $T_J = 150^{\circ}C$; $V_{GE} = 15V$

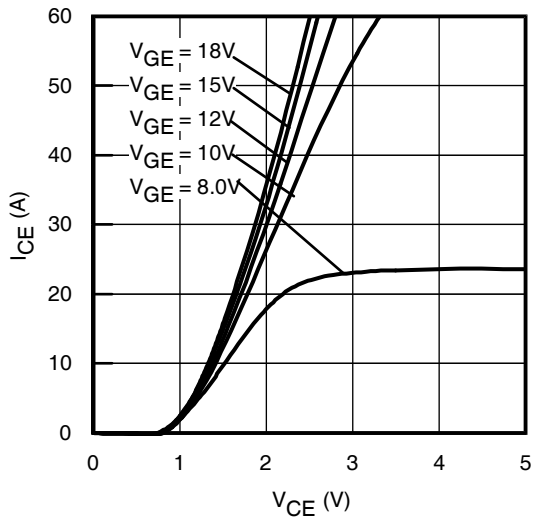

Fig. 5 - Typ. IGBT Output Characteristics
 $T_J = -40^\circ\text{C}$; $t_p = 80\mu\text{s}$

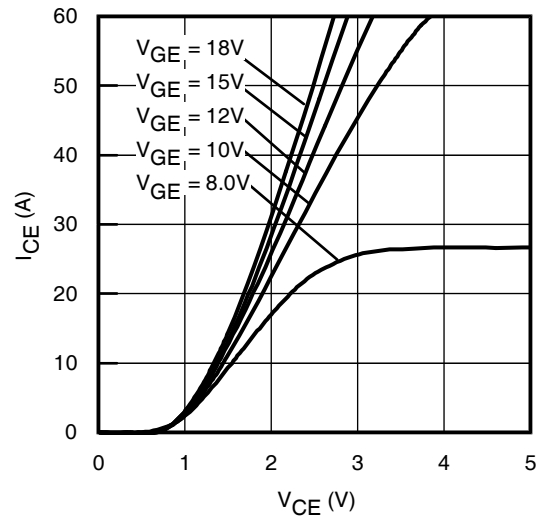

Fig. 6 - Typ. IGBT Output Characteristics
 $T_J = 25^\circ\text{C}$; $t_p = 80\mu\text{s}$

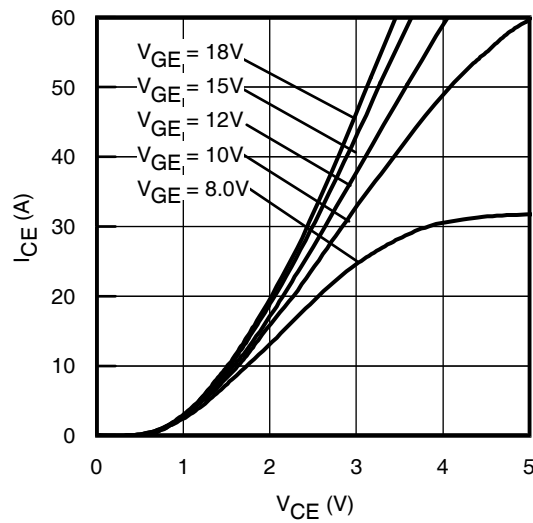

Fig. 7 - Typ. IGBT Output Characteristics
 $T_J = 150^\circ\text{C}$; $t_p = 80\mu\text{s}$

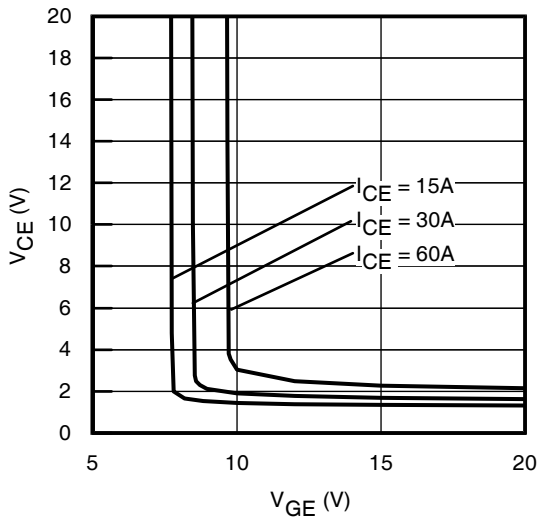

Fig. 8 - Typical V_{CE} vs. V_{GE}
 $T_J = -40^\circ\text{C}$

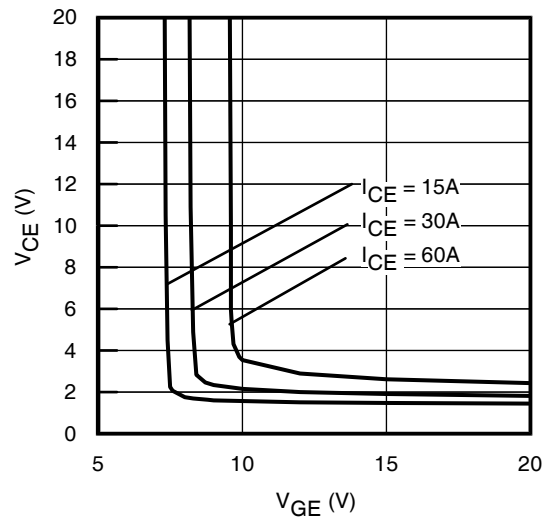

Fig. 9 - Typical V_{CE} vs. V_{GE}
 $T_J = 25^\circ\text{C}$

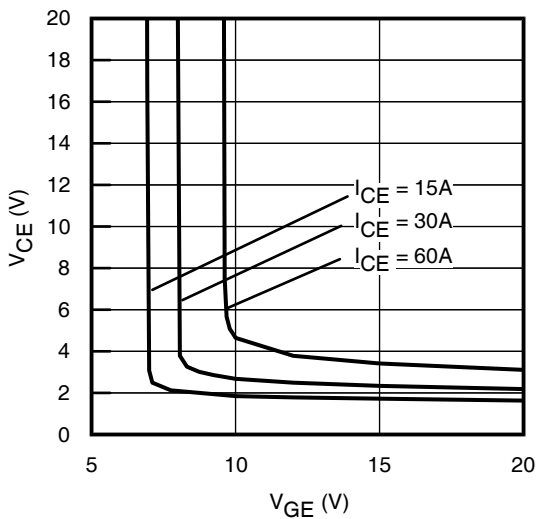

Fig. 10 - Typical V_{CE} vs. V_{GE}
 $T_J = 150^\circ\text{C}$

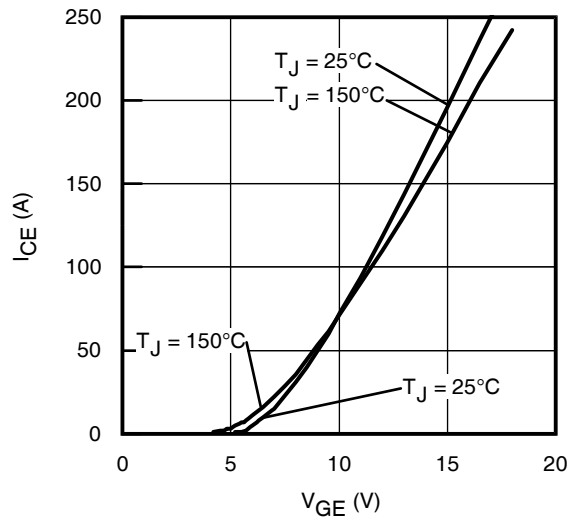

Fig. 11 - Typ. Transfer Characteristics
 $V_{CE} = 50\text{V}$; $t_p = 10\mu\text{s}$

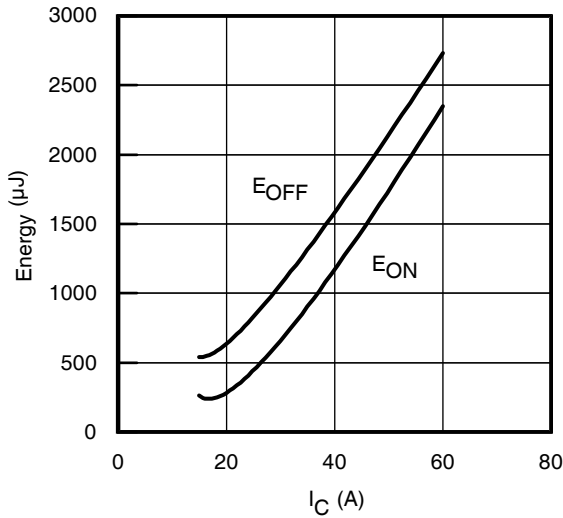

Fig. 12 - Typ. Energy Loss vs. I_C
 $T_J = 150^\circ\text{C}$; $L=200\mu\text{H}$; $V_{CE}= 400\text{V}$,
 $R_G= 10\Omega$; $V_{GE}= 15\text{V}$

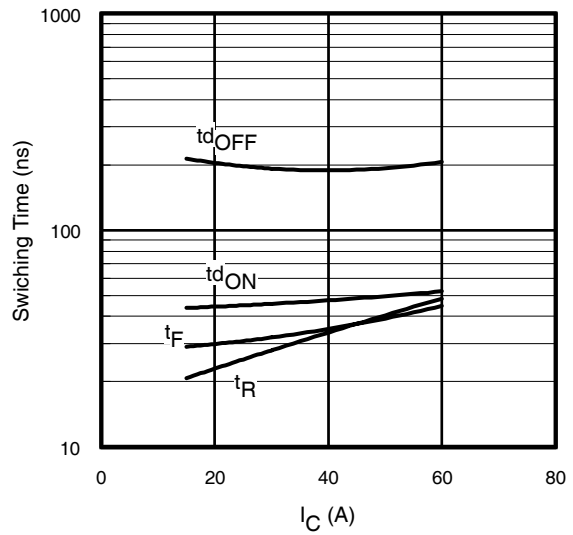

Fig. 13 - Typ. Switching Time vs. I_C
 $T_J = 150^\circ\text{C}$; $L=200\mu\text{H}$; $V_{CE}= 400\text{V}$
 $R_G= 10\Omega$; $V_{GE}= 15\text{V}$

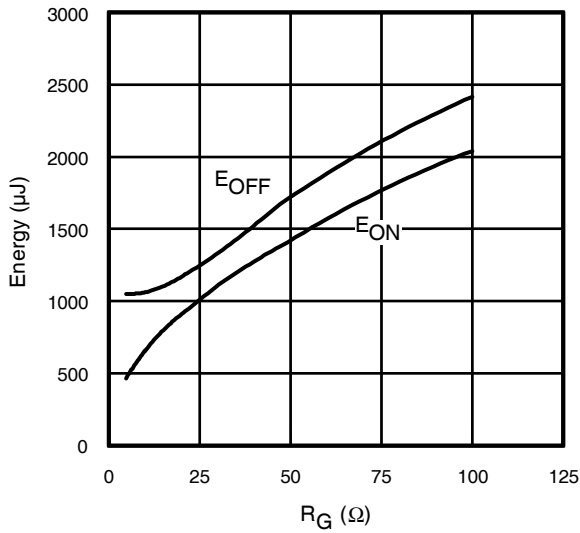

Fig. 14 - Typ. Energy Loss vs. R_G
 $T_J = 150^\circ\text{C}$; $L=200\mu\text{H}$; $V_{CE}= 400\text{V}$
 $I_{CE}= 30\text{A}$; $V_{GE}= 15\text{V}$

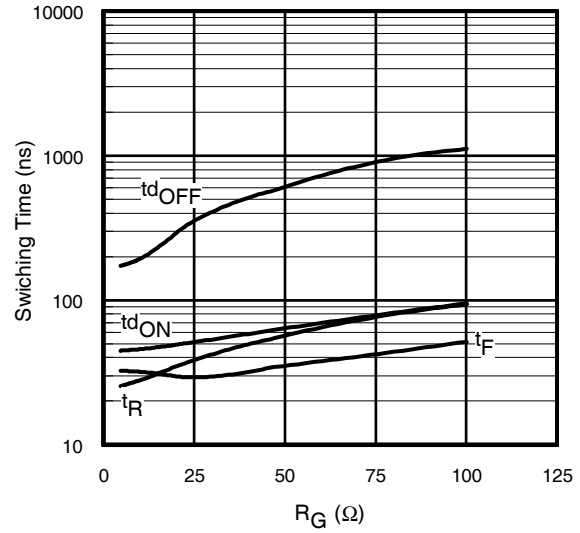

Fig. 15 - Typ. Switching Time vs. R_G
 $T_J = 150^\circ\text{C}$; $L=200\mu\text{H}$; $V_{CE}= 400\text{V}$
 $I_{CE}= 30\text{A}$; $V_{GE}= 15\text{V}$

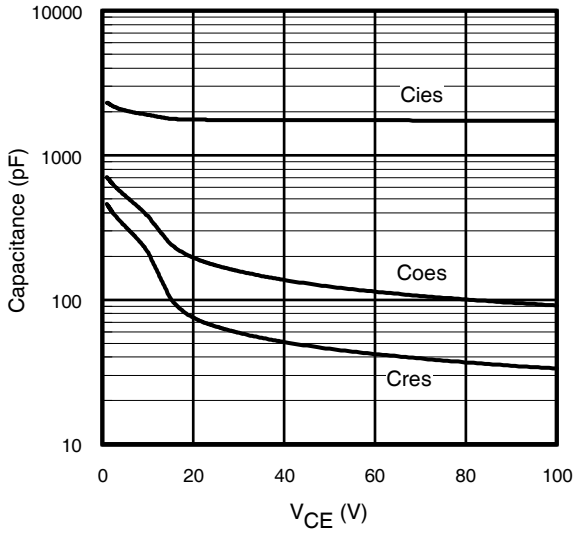

Fig. 16- Typ. Capacitance vs. V_{CE}
V_{GE} = 0V; f = 1MHz

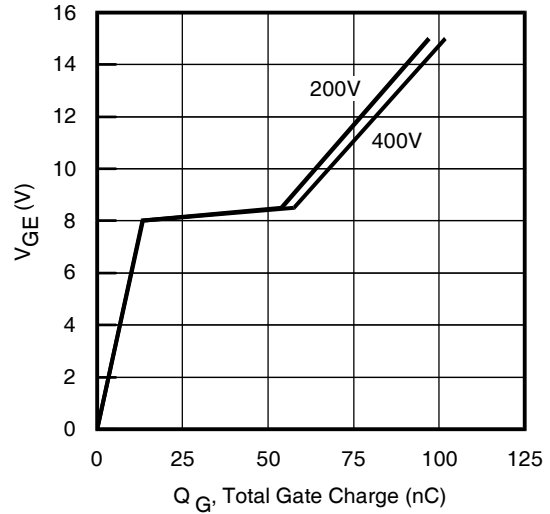

Fig. 17 - Typical Gate Charge vs. V_{GE}
I_{CE} = 30A; L = 600μH

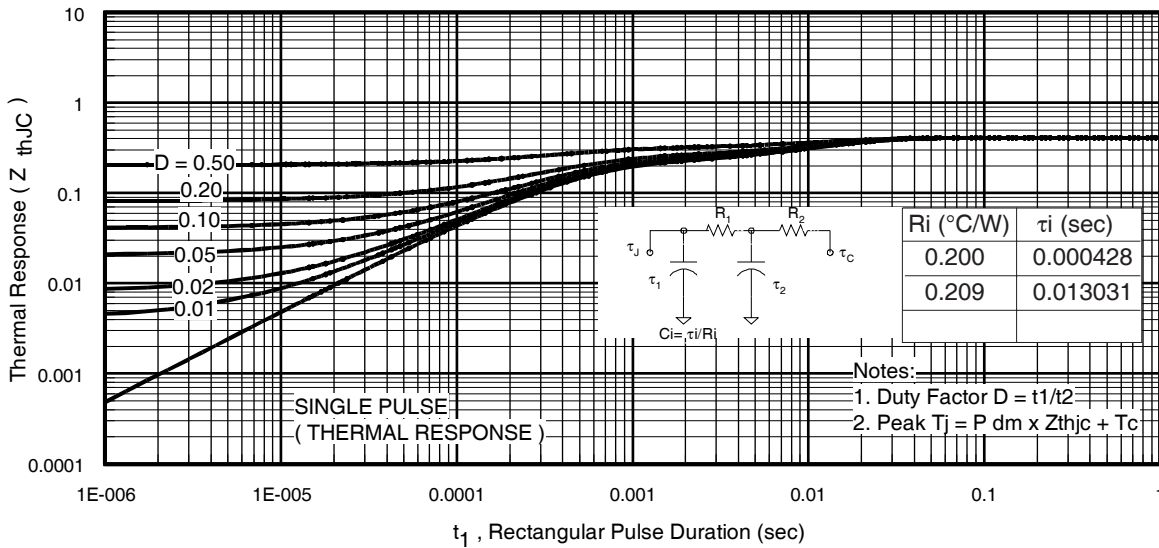

Fig 18. Maximum Transient Thermal Impedance, Junction-to-Case (IGBT)

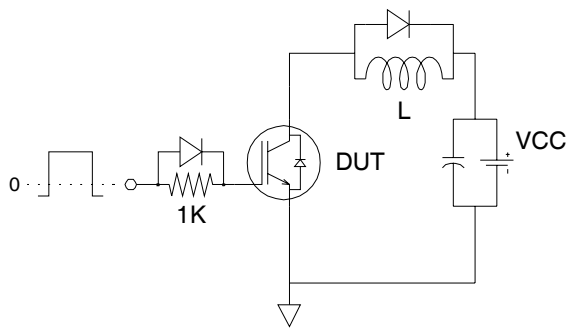

Fig.C.T.1 - Gate Charge Circuit (turn-off)

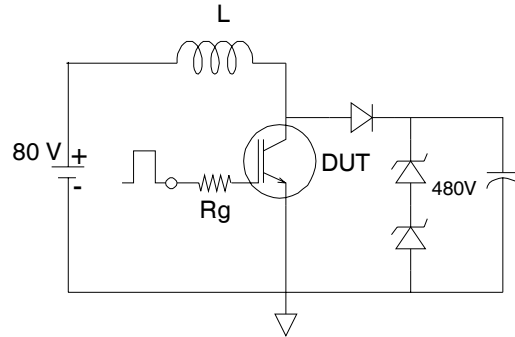

Fig.C.T.2 - RBSOA Circuit

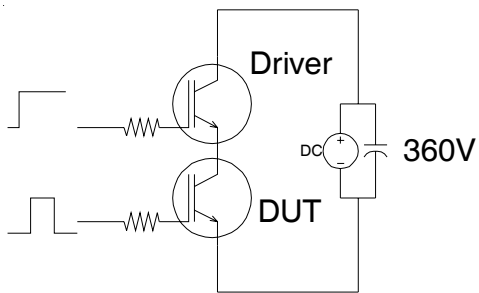

Fig.C.T.3 - S.C.SOA Circuit

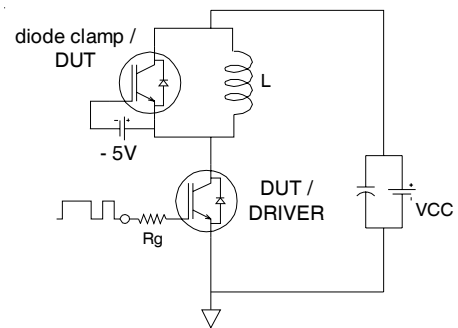

Fig.C.T.4 - Switching Loss Circuit

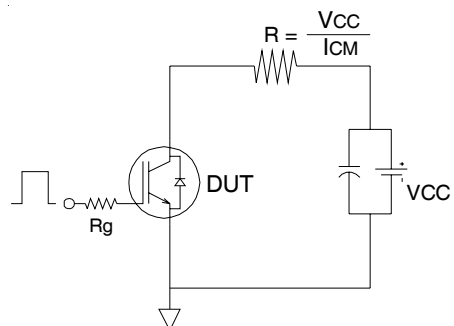

Fig.C.T.5 - Resistive Load Circuit

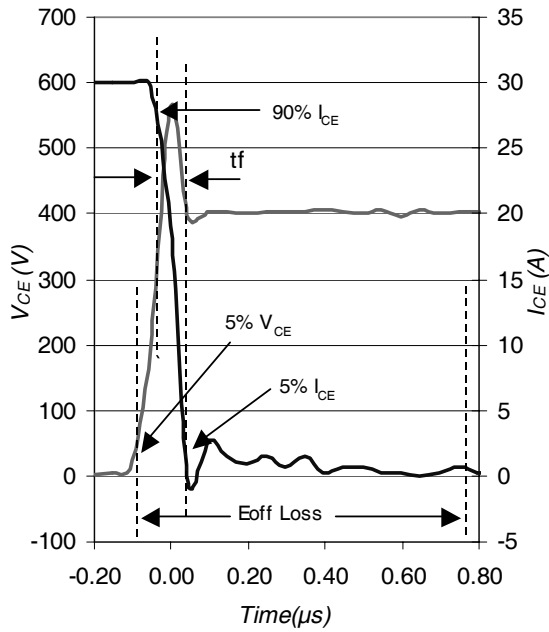

Fig. WF1- Typ. Turn-off Loss Waveform
@ $T_J = 150^\circ\text{C}$ using Fig. CT.4

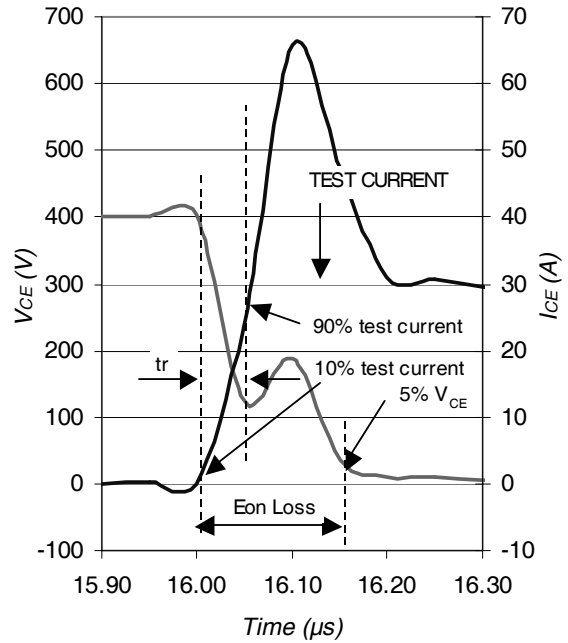

Fig. WF2- Typ. Turn-on Loss Waveform
@ $T_J = 150^\circ\text{C}$ using Fig. CT.4

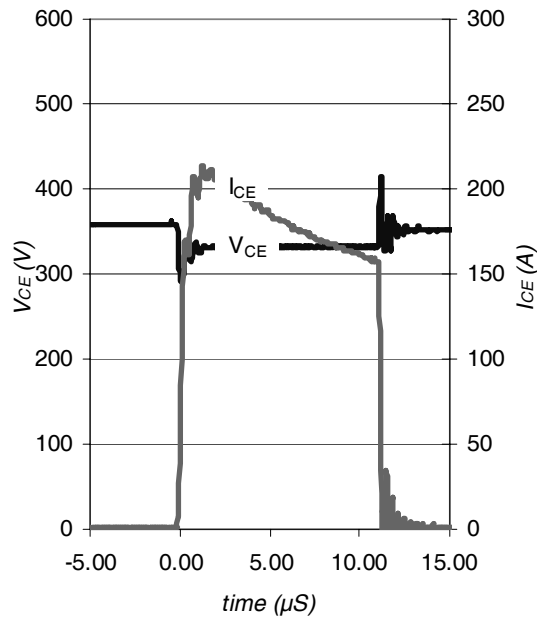
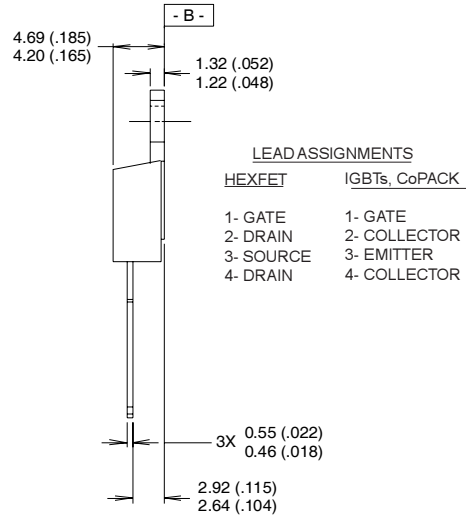
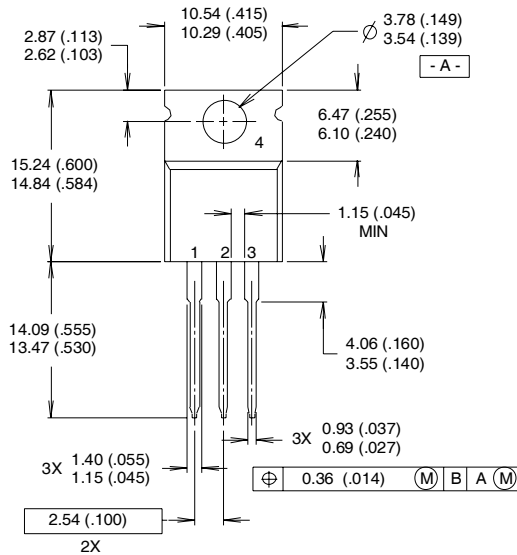

Fig. WF3- Typ. S.C Waveform
@ $T_C = 150^\circ\text{C}$ using Fig. CT.3

IRGB/S/SL30B60K

TO-220AB Package Outline

Dimensions are shown in millimeters (inches)



NOTES:

- 1 DIMENSIONING & TOLERANCING PER ANSI Y14.5M, 1982.
- 2 CONTROLLING DIMENSION : INCH

- 3 OUTLINE CONFORMS TO JEDEC OUTLINE TO-220AB.
- 4 HEATSINK & LEAD MEASUREMENTS DO NOT INCLUDE BURRS.

TO-220AB Part Marking Information

EXAMPLE: THIS IS AN IRF1010
 LOT CODE 1789
 ASSEMBLED ON WW 19, 1997
 IN THE ASSEMBLY LINE "C"

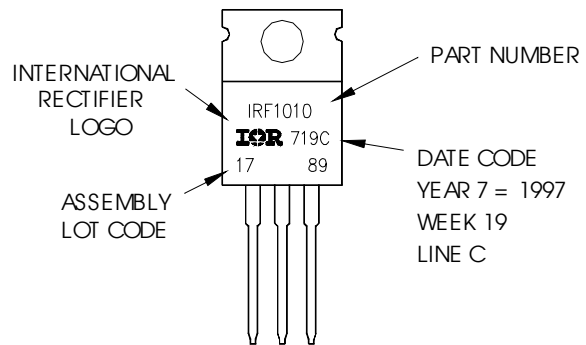

D Pak Package Outline

Dimensions are shown in millimeters (inches)

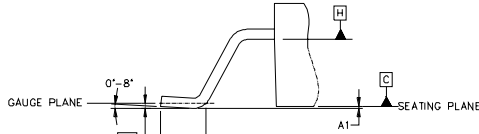

DETAIL "A"
 ROTATED 90°
 SCALE: B:1

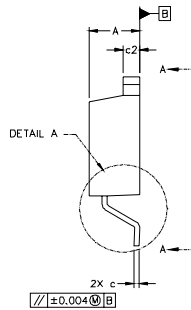
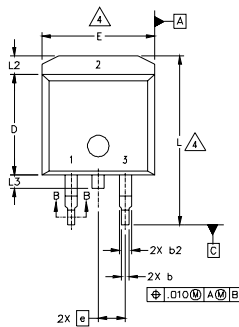
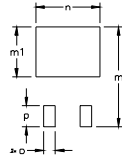
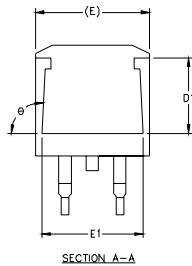
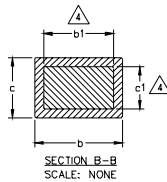

SYMBOL	DIMENSIONS				NOTES
	MILLIMETERS		INCHES		
	MIN.	MAX.	MIN.	MAX.	
A	4.06	4.83	.160	.190	4
A1		0.127		.005	
b	0.51	0.99	.020	.039	
b1	0.51	0.89	.020	.035	
b2	1.14	1.40	.045	.055	4
c	0.43	0.63	.017	.025	
c1	0.38	0.74	.015	.029	3
c2	1.14	1.40	.045	.055	
D	8.51	9.65	.335	.380	3
D1	5.33		.210		
E	9.65	10.67	.380	.420	3
E1	6.22		.245		
e	2.54 BSC		.100 BSC		
L	14.61	15.88	.575	.625	
L1	1.78	2.79	.070	.110	
L2		1.65		.065	
L3	1.27	1.78	.050	.070	
L4	0.25 BSC		.010 BSC		
m	17.78		.700		
m1	8.89		.350		
n	11.43		.450		
o	2.08		.082		
p	3.81		.150		
theta	90°	93°	90°	93°	

LEAD ASSIGNMENTS

HEXFET	IGBTs, CoPACK	DIODES
1.- GATE	1.- GATE	1.- ANODE *
2.- DRAIN	2.- COLLECTOR	2.- CATHODE
3.- SOURCE	3.- EMITTER	3.- ANODE

* PART DEPENDENT.

NOTES:

1. DIMENSIONING AND TOLERANCING PER ASME Y14.5M-1994
2. DIMENSIONS ARE SHOWN IN MILLIMETERS [INCHES]
3. DIMENSION D & E DO NOT INCLUDE MOLD FLASH. MOLD FLASH SHALL NOT EXCEED 0.127 [0.005"] PER SIDE. THESE DIMENSIONS ARE MEASURED AT THE OUTMOST EXTREMES OF THE PLASTIC BODY.
4. DIMENSION b1 AND c1 APPLY TO BASE METAL ONLY.
5. CONTROLLING DIMENSION: INCH.

D Pak Part Marking Information

EXAMPLE: THIS IS AN IRF530S WITH
 LOT CODE 8024
 ASSEMBLED ON WW 02, 2000
 IN THE ASSEMBLY LINE "L"

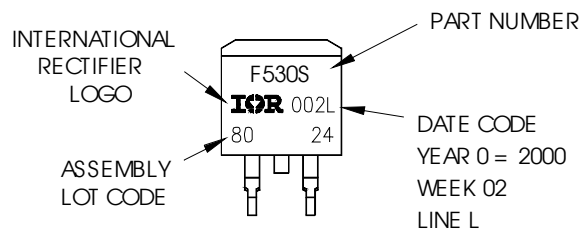

IRGB/S/SL30B60K

TO-262 Package Outline

Dimensions are shown in millimeters (inches)

International
IRF Rectifier

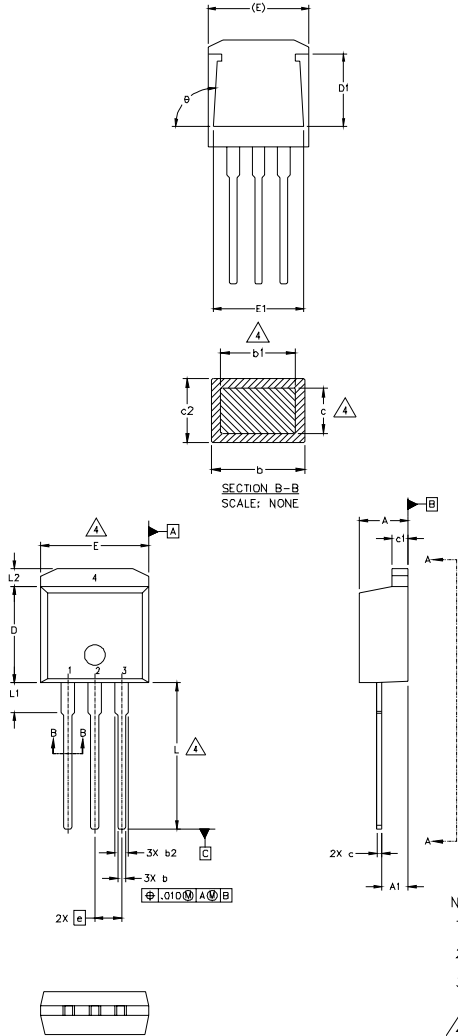

SYMBOL	DIMENSIONS				NOTES
	MILLIMETERS		INCHES		
	MIN.	MAX.	MIN.	MAX.	
A	4.06	4.83	.160	.190	
A1	2.03	2.92	.080	.115	
b	0.51	0.99	.020	.039	
b1	0.51	0.89	.020	.035	4
b2	1.14	1.40	.045	.055	
c	0.38	0.63	.015	.025	4
c1	1.14	1.40	.045	.055	
c2	0.43	.063	.017	.029	
D	8.51	9.65	.335	.380	3
D1	5.33		.210		
E	9.65	10.67	.380	.420	3
E1	6.22		.245		
e	2.54 BSC		.100 BSC		
L	13.46	14.09	.530	.555	
L1	3.56	3.71	.140	.146	
L2		1.65		.065	

LEAD ASSIGNMENTS

HEXFET

- 1.- GATE
- 2.- DRAIN
- 3.- SOURCE
- 4.- DRAIN

IGBT

- 1- GATE
- 2- COLLECTOR
- 3- EMITTER
- 4- COLLECTOR

NOTES:

1. DIMENSIONING AND TOLERANCING PER ASME Y14.5M-1994
2. DIMENSIONS ARE SHOWN IN MILLIMETERS [INCHES]
3. DIMENSION D & E DO NOT INCLUDE MOLD FLASH. MOLD FLASH SHALL NOT EXCEED 0.127 [0.005"] PER SIDE. THESE DIMENSIONS ARE MEASURED AT THE OUTMOST EXTREMES OF THE PLASTIC BODY.
4. DIMENSION b1 AND c1 APPLY TO BASE METAL ONLY.
5. CONTROLLING DIMENSION: INCH.

TO-262 Part Marking Information

EXAMPLE: THIS IS AN IRL3103L
 LOT CODE 1789
 ASSEMBLED ON WW 19, 1997
 IN THE ASSEMBLY LINE "C"

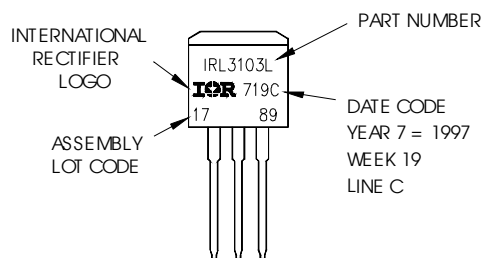

D Pak Tape & Reel Information

Dimensions are shown in millimeters (inches)

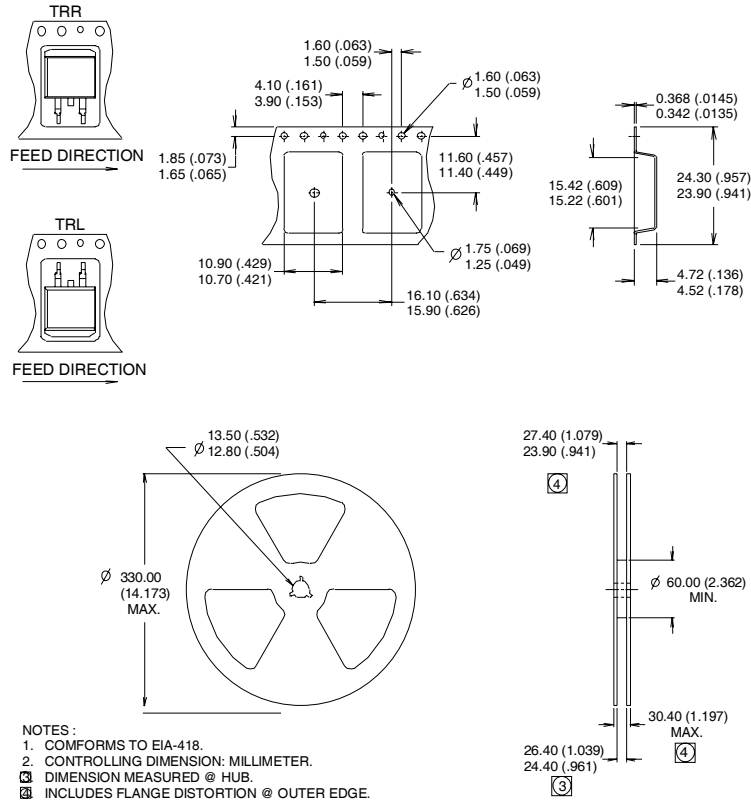

Notes:

- ① $V_{CC} = 80\% (V_{CES})$, $V_{GE} = 15V$, $L = 28\mu H$, $R_G = 22\Omega$.
- ② This is only applied to TO-220AB package.
- ③ This is applied to D²Pak, when mounted on 1" square PCB (FR-4 or G-10 Material).
 For recommended footprint and soldering techniques refer to application note #AN-994.
- ④ Energy losses include "tail" and diode reverse recovery.
- ⑤ Calculated continuous current based on maximum allowable junction temperature. Package limitation current is 75A.

TO-220AB package is not recommended for Surface Mount Application.

Data and specifications subject to change without notice.

Copyright © Each Manufacturing Company.

All Datasheets cannot be modified without permission.

This datasheet has been download from :

www.AllDataSheet.com

100% Free DataSheet Search Site.

Free Download.

No Register.

Fast Search System.

www.AllDataSheet.com