



May 2005

RMPA2259 28 dBm WCDMA PowerEdge™ Power Amplifier Module

Features

- 40% CDMA efficiency at +28dBm average output power
- Single positive-supply operation and low power and shutdown modes
- Meets WCDMA/UTMS and HSDPA performance requirements
- Compact Lead-free compliant LCC package
- 4.0 x 4.0 x 1.5 mm
- Industry standard pinout
- Internally matched to 50Ω and DC blocked RF input/output

General Description

The RMPA2259 power amplifier module (PAM) is designed for WCDMA/UTMS and HSDPA applications. The 2-stage PAM is internally matched to 50Ω to minimize the use of external components and features a low-power mode to reduce standby current and DC power consumption during peak phone usage. High power-added efficiency and excellent linearity are achieved using our InGaP Heterojunction Bipolar Transistor (HBT) process.

Device



Functional Block Diagram

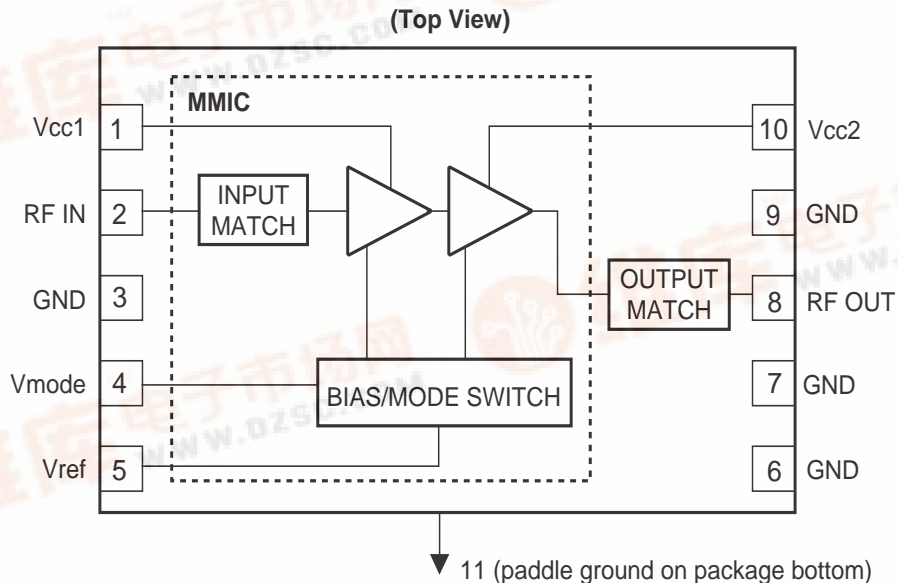

RMPA2259 28 dBm WCDMA Power Edge™ Power Amplifier Module



Absolute Ratings¹

Symbol	Parameter	Ratings	Units
V _{CC1} , V _{CC2}	Supply Voltages	5.0	V
V _{ref}	Reference Voltage	2.6 to 3.5	V
V _{mode}	Power Control Voltage	3.5	V
P _{IN}	RF Input Power	+10	dBm
T _{STG}	Storage Temperature	-55 to +150	°C

Note:

1: No permanent damage with only one parameter set at extreme limit. Other parameters set to typical values.

Electrical Characteristics¹

Symbol	Parameter	Min	Typ	Max	Units	Comments
f	Operating Frequency	1920		1980	MHz	
WCDMA Operation						
Gp	Power Gain		26.5		dB	Po=+28dBm; Vmode=0V
			24		dB	Po=+16dBm; Vmode≥2.0V
Po	Linear Output Power	28			dBm	Vmode=0V
		16			dBm	Vmode≥2.0V
PAEd	PAEd (digital) @ +28dBm		40		%	Vmode=0V
	PAEd (digital) @ +16dBm		9		%	Vmode≥2.0V
	PAEd (digital) @ +16dBm		20		%	Vmode≥2.0V, Vcc=1.4V
Itot	High Power Total Current		450		mA	Po=+28dBm, Vmode=0V
	Low Power Total Current		130		mA	Po=+16dBm, Vmode≥2.0V
	Adjacent Channel Leakage Ratio					WCDMA Modulation 3GPP 3.2 03-00 DPCCH+1 DCDC
ACLR1	±5.0MHz Offset		-40		dBc	Po=+28dBm; Vmode=0V
			-43		dBc	Po=+16dBm; Vmode≥2.0V
ACLR2	±10.0MHz Offset		-53		dBc	Po=+28dBm; Vmode=0V
			-66		dBc	Po=+16dBm; Vmode≥2.0V
General Characteristics						
VSWR	Input Impedance		2.0:1			
NF	Noise Figure		3		dB	
Rx No	Receive Band Noise Power		-139		dBm/Hz	Po≤+28dBm; 2110 to 2170MHz
2fo-5fo	Harmonic Suppression ³			-30	dBc	Po≤+28dBm
S	Spurious Outputs ^{2,3}			-60	dBc	Load VSWR ≤ 5.0:1
	Ruggedness w/ Load Mismatch ³			10:1		No permanent damage
Tc	Case Operating Temperature	-30		85	°C	
DC Characteristics						
Iccq	Quiescent Current		50		mA	Vmode≥2.0V
Iref	Reference Current		5	8	mA	Po≤+28dBm
Icc(off)	Shutdown Leakage Current		1	5	µA	No applied RF signal

Notes:

1: All parameters met at Tc = +25°C, Vcc = +3.4V, f = 1950MHz, and load VSWR ≤ 1.2:1.

2: All phase angles.

3: Guaranteed by design.

Recommended Operating Conditions¹

Symbol	Parameter	Min	Typ	Max	Units
f	Operating Frequency	1920		1980	MHz
Vcc1, Vcc2	Supply Voltage	3.0	3.4	4.2	V
Vref	Reference Voltage				
	Operating	2.7	2.85	3.1	V
Vmode	Shutdown	0		0.5	V
	Bias Control Voltage				
Vmode	Low-Power	1.8	2.0	3.0	V
	High-Power	0		0.5	V
Pout	Linear Output Power				
	High-Power			+28	dBm
	Low-Power			+16	dBm
Tc	Case Operating Temperature	-30		+85	°C

Note:

1: RF input power for WCDMA Pout = +28dBm.

DC Turn On Sequence:

- Vcc1 = Vcc2 = 3.4V (typical)
- Vref = 2.85V (typical)
- High-Power: Vmode = 0V (Pout > 16dBm)
Low-Power: Vmode = 2.0V (Pout < 16dBm)

Performance Data

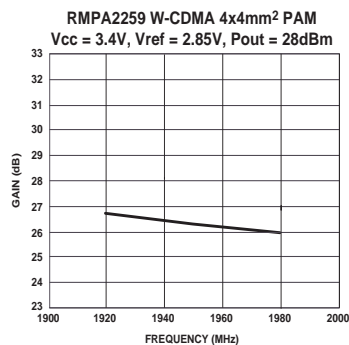

Figure 1.

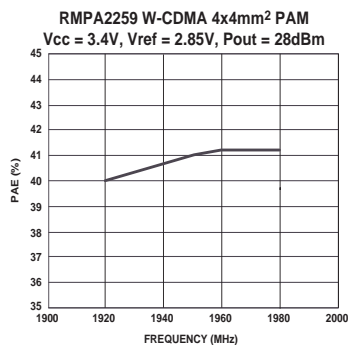

Figure 2.

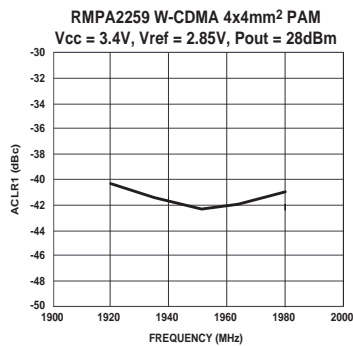

Figure 3.

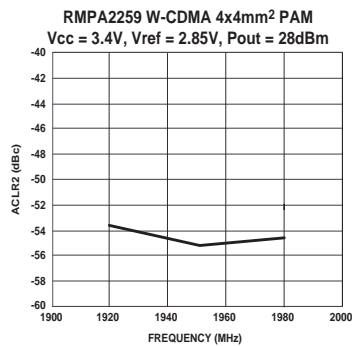

Figure 4.

Efficiency Improvement Application

In addition to high-power/low-power bias modes, the efficiency of the PA module can be significantly increased at backed-off RF power levels by dynamically varying the supply voltage (V_{CC}) applied to the amplifier. Since mobile handsets and power amplifiers frequently operate at 10–20dB back-off, or more, from maximum rated linear power, battery life is highly dependent on the DC power consumed at antenna power levels in the range of 0 to +16dBm. The reduced demand on transmitted RF power allows the PA supply voltage to be reduced for improved efficiency, while still meeting linearity requirements for CDMA modulation with excellent margin. High-efficiency DC-DC converters are now available to implement switched-voltage operation.

The following charts show measured performance of the PA module in low-power mode ($V_{mode} = +2.0V$) at +16dBm output power and over a range of supply voltages from 3.4V nominal to 1.2V. Power-added efficiency is more than doubled from 9.5 percent to nearly 25 percent ($V_{CC} = 1.2V$) while maintaining a typical ACLR1 of -46dBc and ACLR2 of approximately -60dBc.

Operation at even lower levels of V_{CC} supply voltage are possible with a further restriction on the maximum RF output power. As shown below, the PA module can be biased at a supply voltage of as low as 0.7V with an efficiency as high as 10–12 percent at +8dBm output power. Excellent signal linearity is still maintained even under this low supply voltage condition.

Performance Data (continued)

Low-Power Mode ($P_o = +16dBm$)

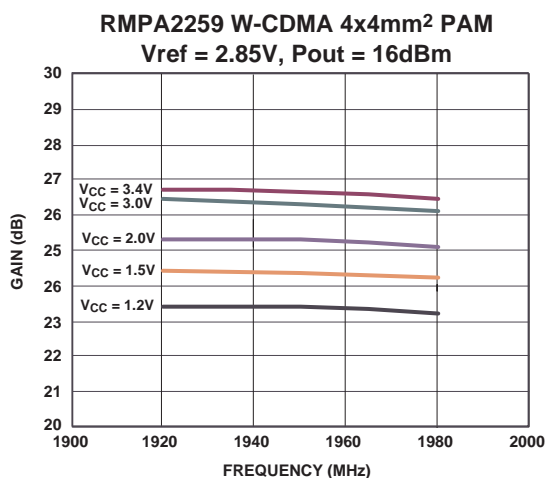

Figure 5.

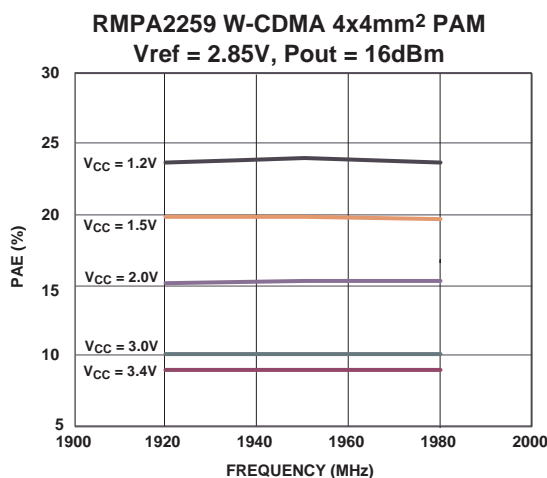

Figure 6.

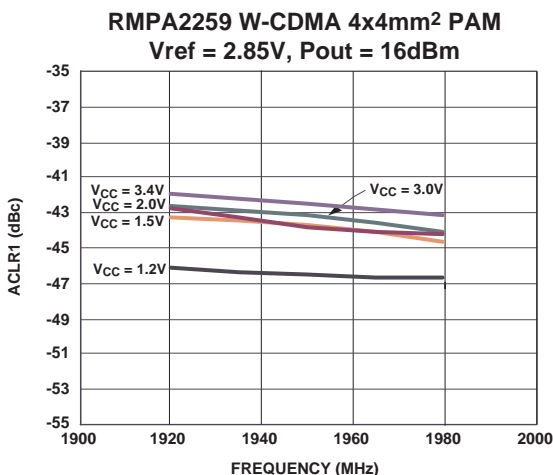

Figure 7.

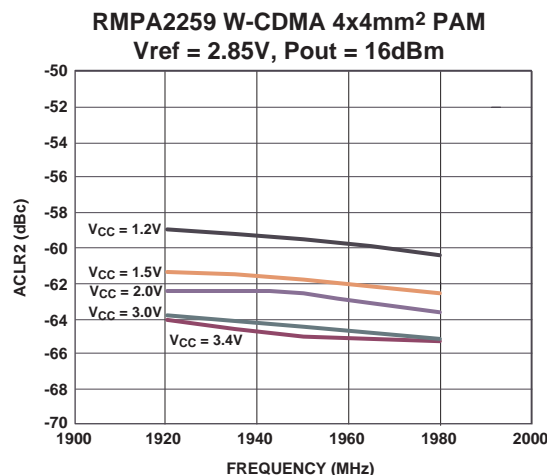

Figure 8.

Performance Data (continued)

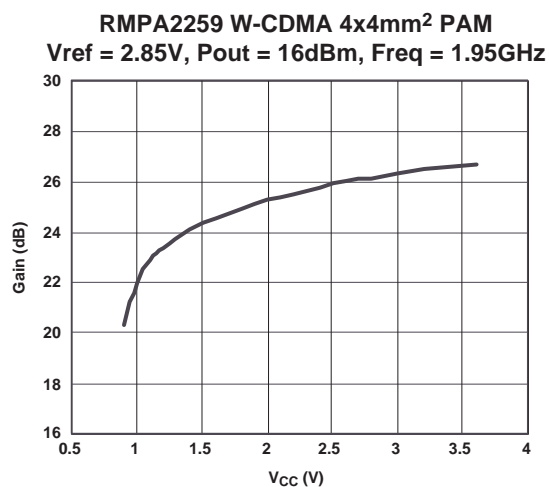

Figure 9.

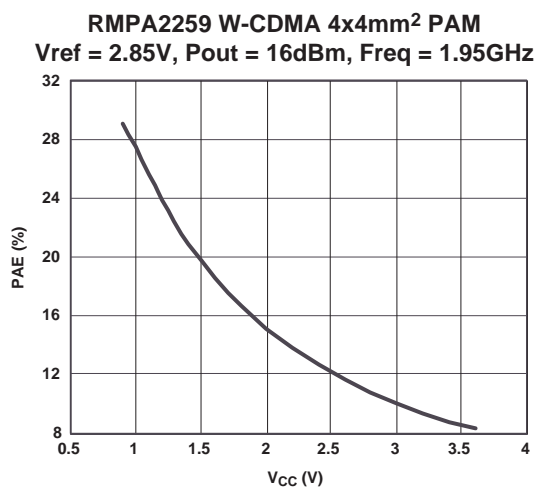

Figure 10.

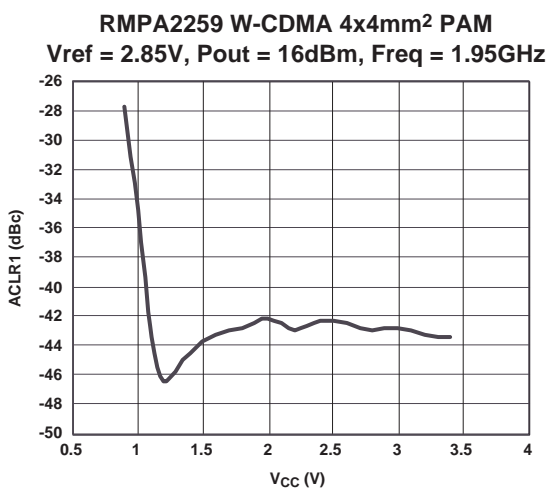

Figure 11.

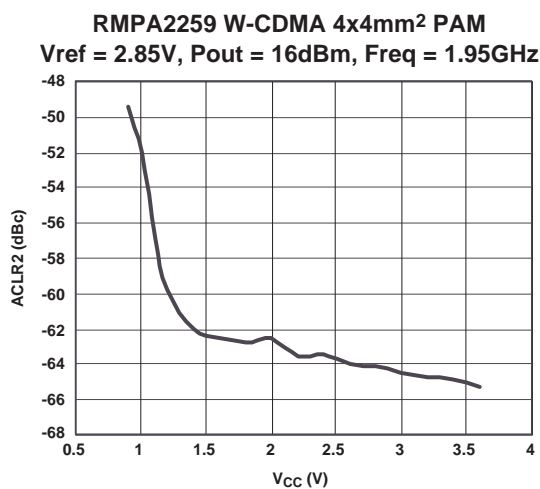

Figure 12.

Performance Data (continued)

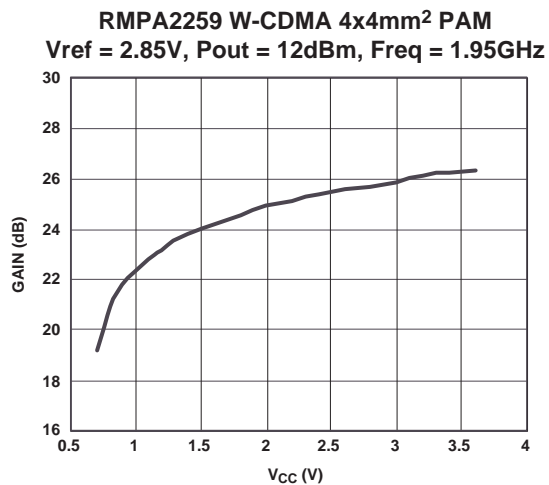

Figure 13.

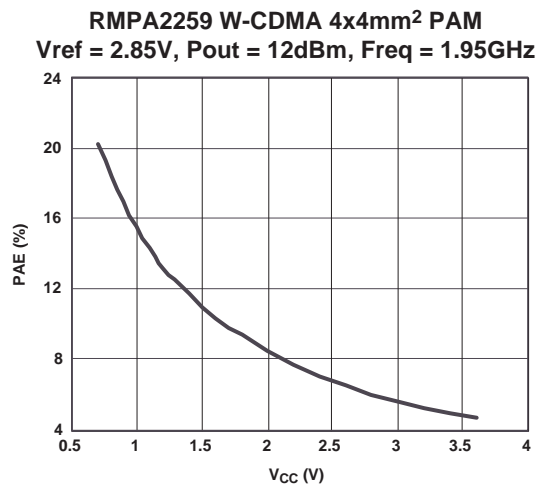

Figure 14.

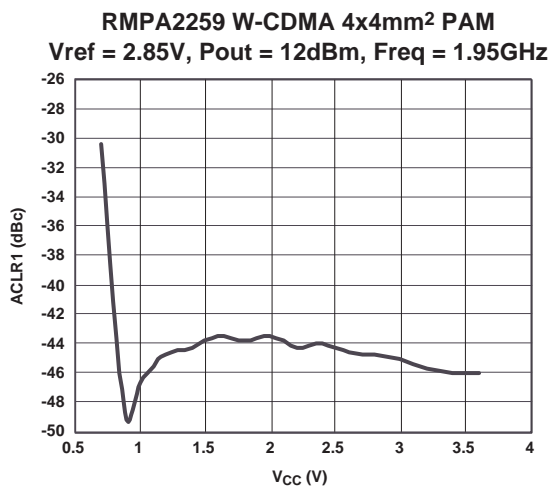

Figure 15.

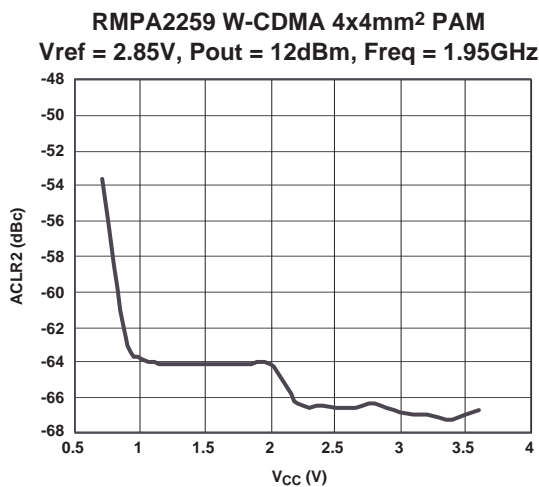

Figure 16.

Performance Data (continued)

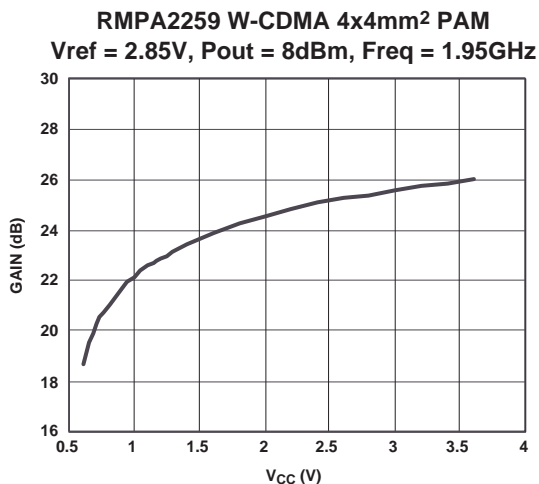

Figure 17.

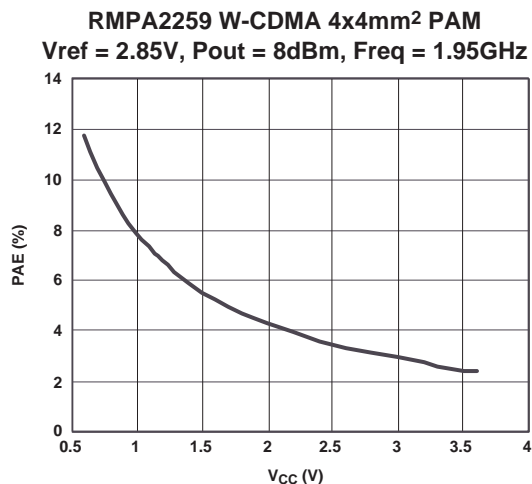

Figure 18.

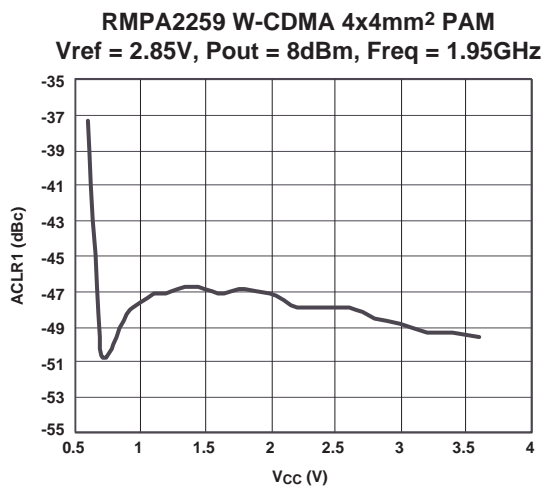

Figure 19.

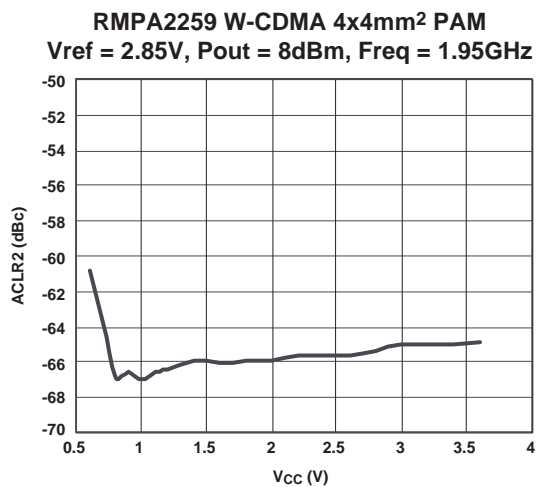
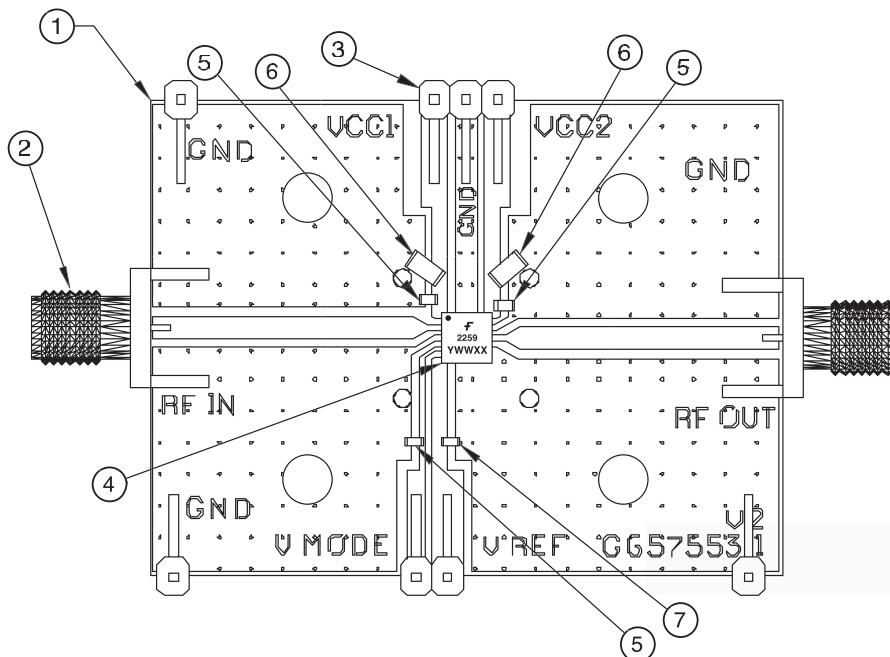

Figure 20.

Evaluation Board Layout



Materials List

Qty	Item No.	Part Number	Description	Vendor
1	1	G657553-1 V2	PC Board	Fairchild
	2	#142-0701-841	SMA Connector	Johnson
	3	#2340-5211TN	Terminals	3M
Ref	4	G657687	Assembly, RMPA2059	Fairchild
3	5	GRM39XR102KS0V	1000pF Capacitor (0603)	Murata
3	5 (Alt)	ECJ-1V81H102K	1000pF Capacitor (0603)	Panasonic
2	6	C3216X5R1A335M	3.3µF Capacitor (1206)	TDK
1	7	GRM39YSV104Z16V	0.1µF Capacitor (0603)	Murata
1	7 (Alt)	ECJ-1VB1CID4K	0.1µF Capacitor (0603)	Panasonic
A/R	8	SN63	Solder Paste	Indium Corp.
A/R	9	SN96	Solder Paste	Indium Corp.

Evaluation Board Schematic

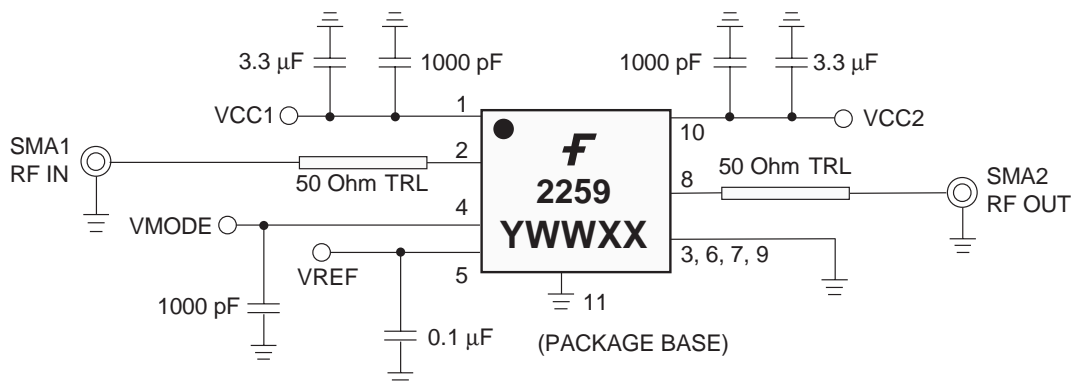

Package Outline

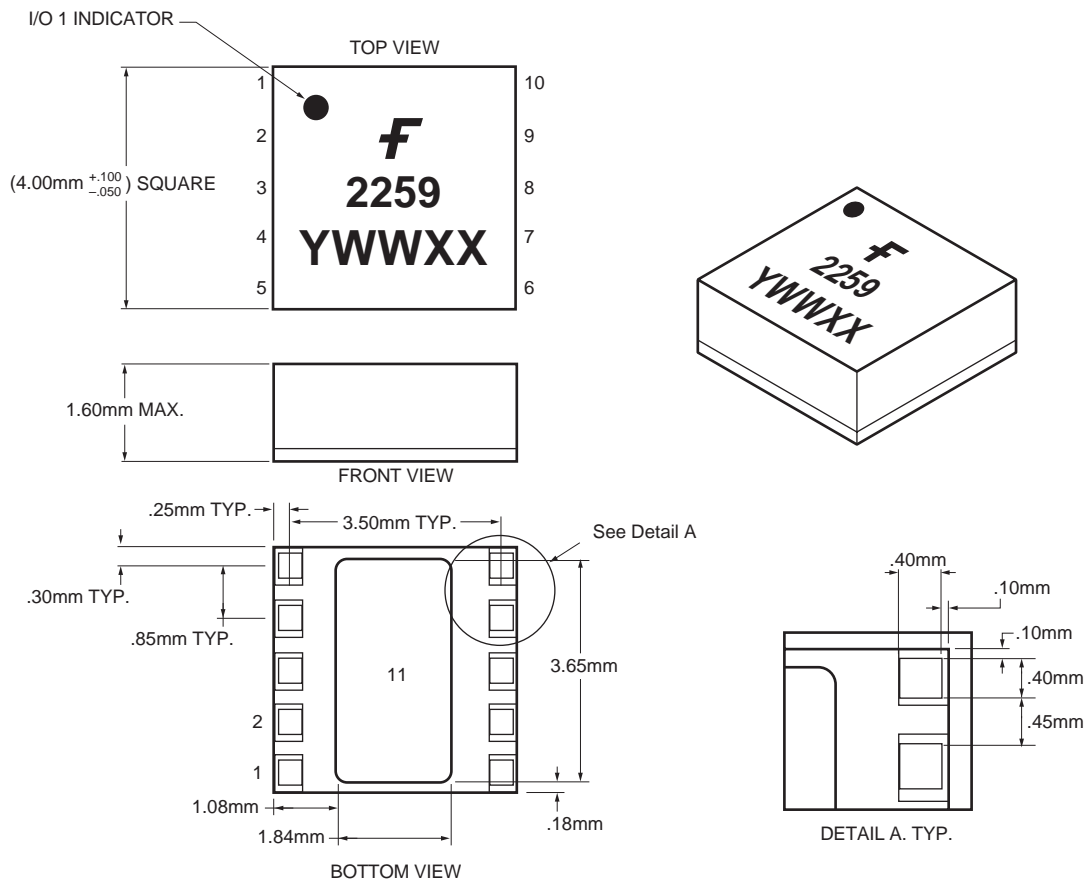

Signal Descriptions

Pin #	Signal Name	Description
1	Vcc1	Reference Voltage
2	RF In	High Power/Low Power Mode Control
3	GND	Ground
4	Vmode	RF Input Signal
5	Vref	Supply Voltage to Input Stage
6	GND	Ground
7	GND	Ground
8	RF Out	RF Output Signal
9	GND	Ground
10	Vcc2	Supply Voltage to Output Stage
11	GND	Paddle Ground

Applications Information

CAUTION: THIS IS AN ESD SENSITIVE DEVICE.

Precautions to Avoid Permanent Device Damage:

- **Cleanliness:** Observe proper handling procedures to ensure clean devices and PCBs. Devices should remain in their original packaging until component placement to ensure no contamination or damage to RF, DC and ground contact areas.
- **Device Cleaning:** Standard board cleaning techniques should not present device problems provided that the boards are properly dried to remove solvents or water residues.
- **Static Sensitivity:** Follow ESD precautions to protect against ESD damage:
 - A properly grounded static-dissipative surface on which to place devices.
 - Static-dissipative floor or mat.
 - A properly grounded conductive wrist strap for each person to wear while handling devices.
- **General Handling:** Handle the package on the top with a vacuum collet or along the edges with a sharp pair of bent tweezers. Avoiding damaging the RF, DC, and ground contacts on the package bottom. Do not apply excessive pressure to the top of the lid.
- **Device Storage:** Devices are supplied in heat-sealed, moisture-barrier bags. In this condition, devices are protected and require no special storage conditions. Once the sealed bag has been opened, devices should be stored in a dry nitrogen environment.

Device Usage:

Fairchild recommends the following procedures prior to assembly.

- Dry-bake devices at 125°C for 24 hours minimum. Note: The shipping trays cannot withstand 125°C baking temperature.
- Assemble the dry-baked devices within 7 days of removal from the oven.
- During the 7-day period, the devices must be stored in an environment of less than 60% relative humidity and a maximum temperature of 30°C
- If the 7-day period or the environmental conditions have been exceeded, then the dry-bake procedure must be repeated.

TRADEMARKS

The following are registered and unregistered trademarks Fairchild Semiconductor owns or is authorized to use and is not intended to be an exhaustive list of all such trademarks.

ACEx™	FAST®	IntelliMAX™	POP™	SPM™
ActiveArray™	FASTr™	ISOPLANAR™	Power247™	Stealth™
Bottomless™	FPS™	LittleFET™	PowerEdge™	SuperFET™
CoolFET™	FRFET™	MICROCOUPLER™	PowerSaver™	SuperSOT™-3
CROSSVOLT™	GlobalOptoisolator™	MicroFET™	PowerTrench®	SuperSOT™-6
DOME™	GTO™	MicroPak™	QFET®	SuperSOT™-8
EcoSPARK™	HiSeC™	MICROWIRE™	QS™	SyncFET™
E ² CMOS™	IC™	MSX™	QT Optoelectronics™	TinyLogic®
EnSigna™	i-Lo™	MSXPro™	Quiet Series™	TINYOPTO™
FACT™	ImpliedDisconnect™	OCX™	RapidConfigure™	TruTranslation™
FACT Quiet Series™		OCXPro™	RapidConnect™	UHC™
Across the board. Around the world.™		OPTOLOGIC®	µSerDes™	UltraFET®
The Power Franchise®		OPTOPLANAR™	SILENT SWITCHER®	UniFET™
Programmable Active Droop™		PACMAN™	SMART START™	VCX™

DISCLAIMER

FAIRCHILD SEMICONDUCTOR RESERVES THE RIGHT TO MAKE CHANGES WITHOUT FURTHER NOTICE TO ANY PRODUCTS HEREIN TO IMPROVE RELIABILITY, FUNCTION OR DESIGN. FAIRCHILD DOES NOT ASSUME ANY LIABILITY ARISING OUT OF THE APPLICATION OR USE OF ANY PRODUCT OR CIRCUIT DESCRIBED HEREIN; NEITHER DOES IT CONVEY ANY LICENSE UNDER ITS PATENT RIGHTS, NOR THE RIGHTS OF OTHERS.

LIFE SUPPORT POLICY

FAIRCHILD'S PRODUCTS ARE NOT AUTHORIZED FOR USE AS CRITICAL COMPONENTS IN LIFE SUPPORT DEVICES OR SYSTEMS WITHOUT THE EXPRESS WRITTEN APPROVAL OF FAIRCHILD SEMICONDUCTOR CORPORATION. As used herein:

1. Life support devices or systems are devices or systems which, (a) are intended for surgical implant into the body, or (b) support or sustain life, or (c) whose failure to perform when properly used in accordance with instructions for use provided in the labeling, can be reasonably expected to result in significant injury to the user.
2. A critical component is any component of a life support device or system whose failure to perform can be reasonably expected to cause the failure of the life support device or system, or to affect its safety or effectiveness.

PRODUCT STATUS DEFINITIONS

Definition of Terms

Datasheet Identification	Product Status	Definition
Advance Information	Formative or In Design	This datasheet contains the design specifications for product development. Specifications may change in any manner without notice.
Preliminary	First Production	This datasheet contains preliminary data, and supplementary data will be published at a later date. Fairchild Semiconductor reserves the right to make changes at any time without notice in order to improve design.
No Identification Needed	Full Production	This datasheet contains final specifications. Fairchild Semiconductor reserves the right to make changes at any time without notice in order to improve design.
Obsolete	Not In Production	This datasheet contains specifications on a product that has been discontinued by Fairchild semiconductor. The datasheet is printed for reference information only.

Rev. 115