

TOSHIBA

S-AU57

TOSHIBA RF POWER AMPLIFIER MODULE

S-AU57

UHF BAND HAM FM RF POWER AMPLIFIER MODULE

Unit in mm

HAND-HELD TRANSCEIVER

MAXIMUM RATINGS (Tc = 25°C)

CHARACTERISTIC	SYMBOL	RATING	UNIT
DC Supply Voltage	V _{DD}	17	V
DC Supply Voltage	V _{GG}	6	V
Input Power	P _i	50	mW
Output Power	P _o	12	W
Total Current	I _T	3	A
Operating Case Temperature Range	T _c (opr)	-30~100	°C
Storage Temperature Range	T _{stg}	-40~110	°C

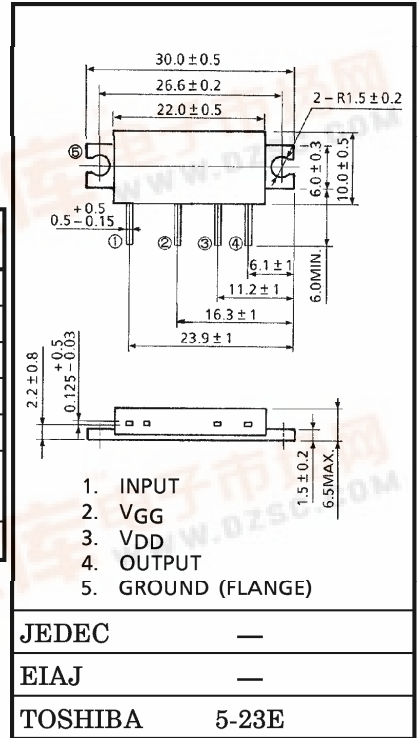

ELECTRICAL CHARACTERISTICS (Tc = 25°C)

Weight : 3.5g

CHARACTERISTIC	SYMBOL	TEST CONDITION	MIN.	TYP.	MAX.	UNIT
Frequency Range	f _{range}	—	430	—	450	MHz
Output Power	P _o	V _{DD} = 9.6V V _{GG} = 4V P _i = 20mW Z _G = Z _L = 50Ω	7	—	—	W
Power Gain	G _p		25.4	—	—	dB
Total Efficiency	η _T		40	—	—	%
Input VSWR	VSWR _{in}		—	—	3.0	—
Harmonics	HRM		—	—	-25	dBc
Load Mismatch	—	V _{DD} = 15V, P _i = 20mW P _o = 7W (V _{GG} = adjust) VSWR LOAD 20 : 1 ALL PHASE	No Degradation			—
Stability	—	V _{DD} = 7.5~11.5V, V _{GG} = 0~4V P _i = 20mW VSWR LOAD 3 : 1 ALL PHASE	All spurious output than 60dB below desired signal			—

CAUTION

- This product has intersetting cap. Please pay attention for exceeding stress and foreign matter in your application. And not to take away the cap.
- Do not intermingle with normal industrial or domestic waste.
- This product is electrostatic sensitivity, please handle with caution.

961001EAA2

● TOSHIBA is continually working to improve the quality and the reliability of its products. Nevertheless, semiconductor devices in general can malfunction or fail due to their inherent electrical sensitivity and vulnerability to physical stress. It is the responsibility of the buyer, when utilizing TOSHIBA products, to observe standards of safety, and to avoid situations in which a malfunction or failure of a TOSHIBA product could cause loss of human life, bodily injury or damage to property. In developing your designs, please ensure that TOSHIBA products are used within specified operating ranges as set forth in the most recent products specifications. Also, please keep in mind the precautions and conditions set forth in the TOSHIBA Semiconductor Reliability Handbook.

● The information contained herein is presented only as a guide for the applications of our products. No responsibility is assumed by TOSHIBA CORPORATION for any infringements of intellectual property or other rights of the third parties which may result from its use. No license is granted by implication or otherwise under any intellectual property or other rights of TOSHIBA CORPORATION or others.

● The information contained herein is subject to change without notice.

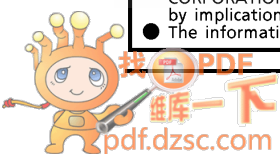

SCHEMATIC

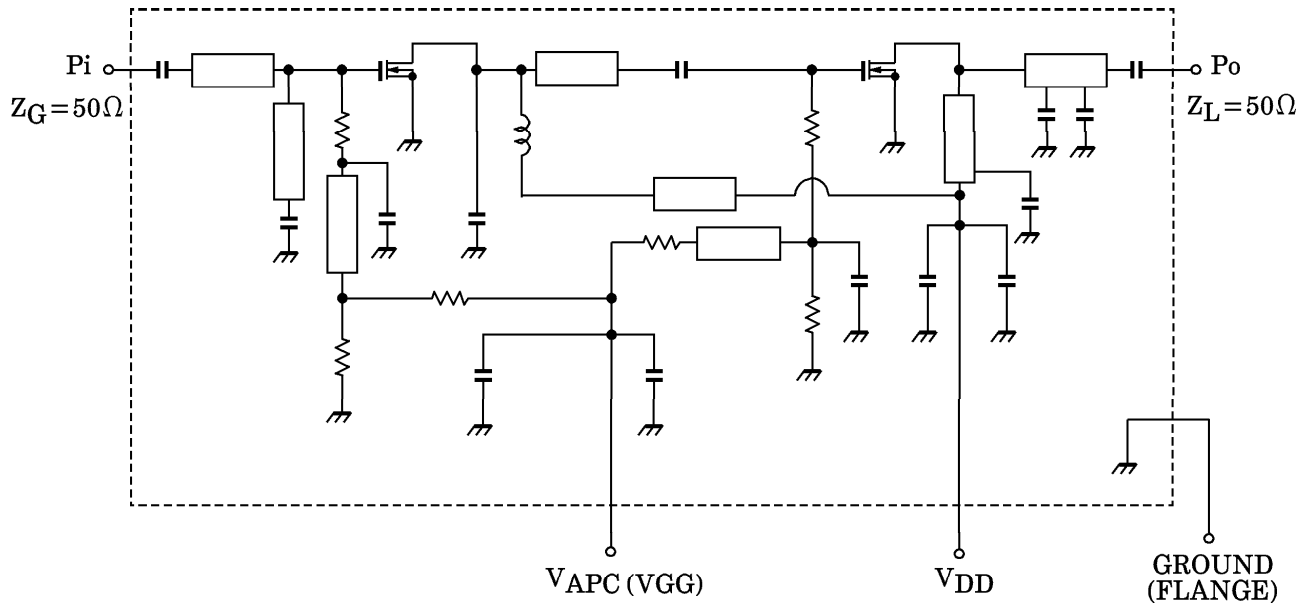

TEST FIXTURE

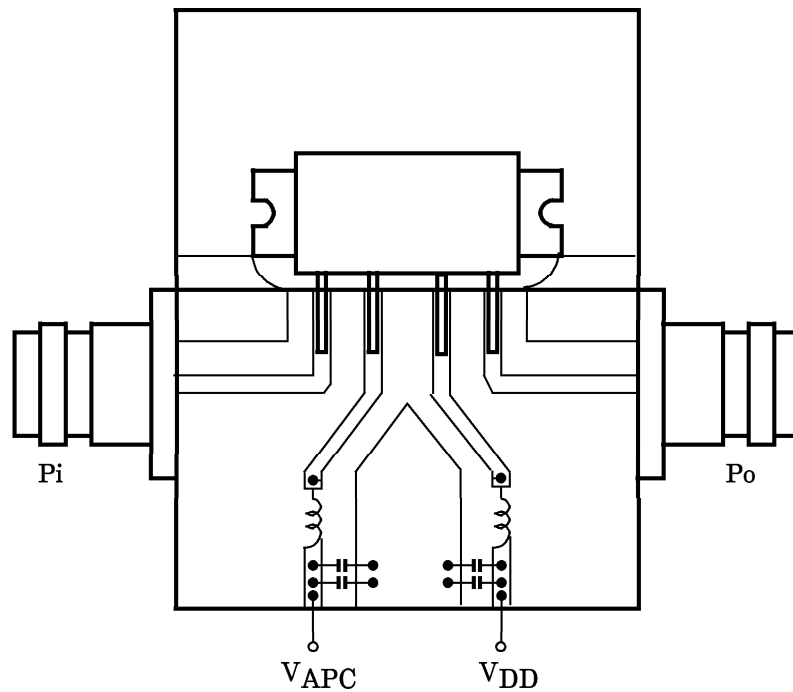

C : 10000pF, 10 μ F PARALLEL
 L : ϕ 0.5, 3ID, 5T ENAMEL WIRE

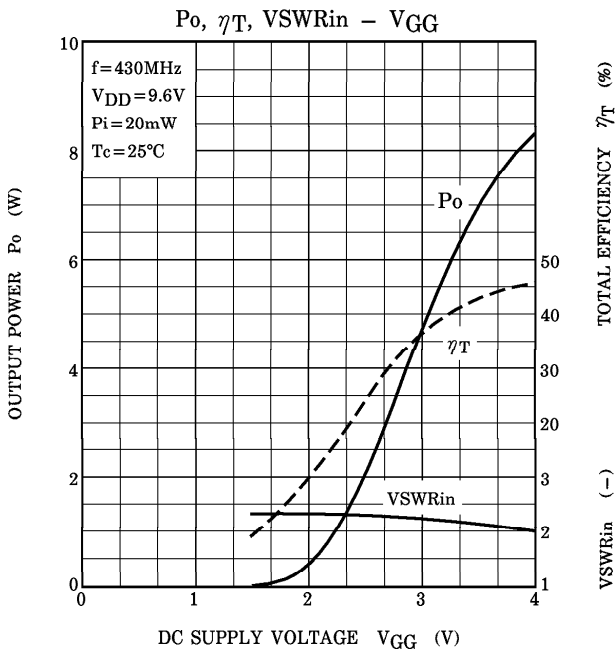
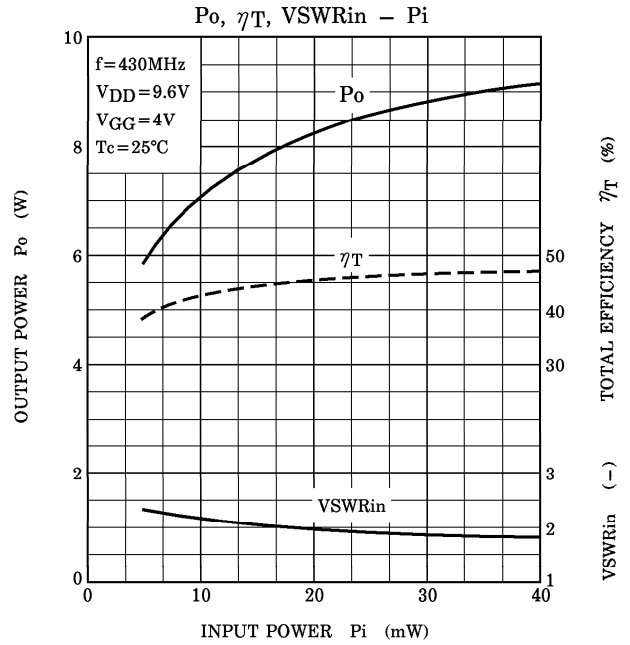
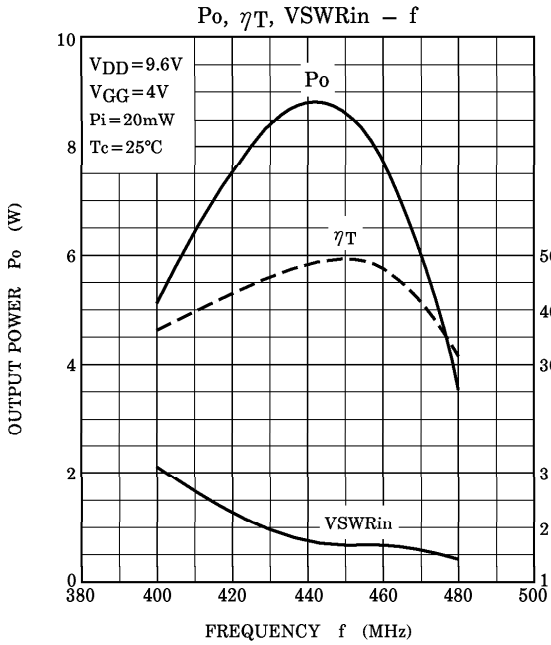

CAUTION

These are only typical curves and devices are not necessarily guaranteed at these curves.