

SHINDENGEN

Super Fast Recovery Rectifiers

Single

S20L60

600V 20A

FEATURES

- High Voltage
- trr100ns
- Small jc

APPLICATION

- PFC
- Switching power supply
- Free Wheel
- Home Appliances, Office Equipment,
- Factory Automation

OUTLINE DIMENSIONS

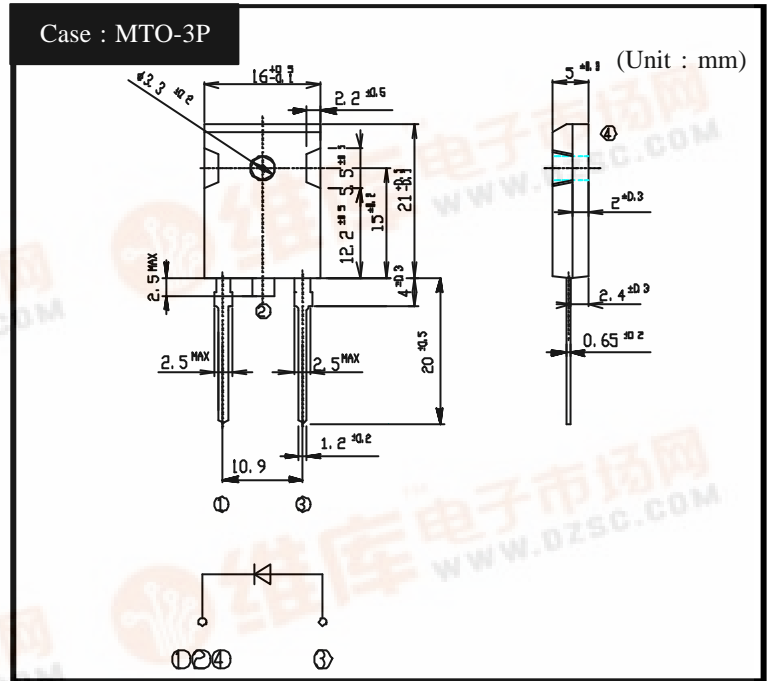

RATINGS

Absolute Maximum Ratings (If not specified Tc=25)

Item	Symbol	Conditions	Ratings	Unit
Storage Temperature	Tstg		-55 ~ 150	
Operating Junction Temperature	Tj		150	
Maximum Reverse Voltage	V _{RM}		600	V
Average Rectified Forward Current	I _o	50Hz sine wave, R-load, Tc=119	20	A
Peak Surge Forward Current	I _{FSM}	50Hz sine wave, Non-repetitive 1 cycle peak value, Tj=25	400	A
Mounting Torque	TOR	(Recommended torque 0.5N·m)	0.8	N·m

Electrical Characteristics (If not specified Tc=25)

Item	Symbol	Conditions	Ratings	Unit
Forward Voltage	V _F	I _F =20A, Pulse measurement	Max.1.5	V
Reverse Current	I _r	V _R =V _{RM} , Pulse measurement	Max.25	μA
Reverse Recovery Time	t _{rr}	I _F =0.5A, I _R =1A	Max.100	ns
Thermal Resistance	jc	junction to case	Max.0.9	/W



S20L60

Forward Voltage

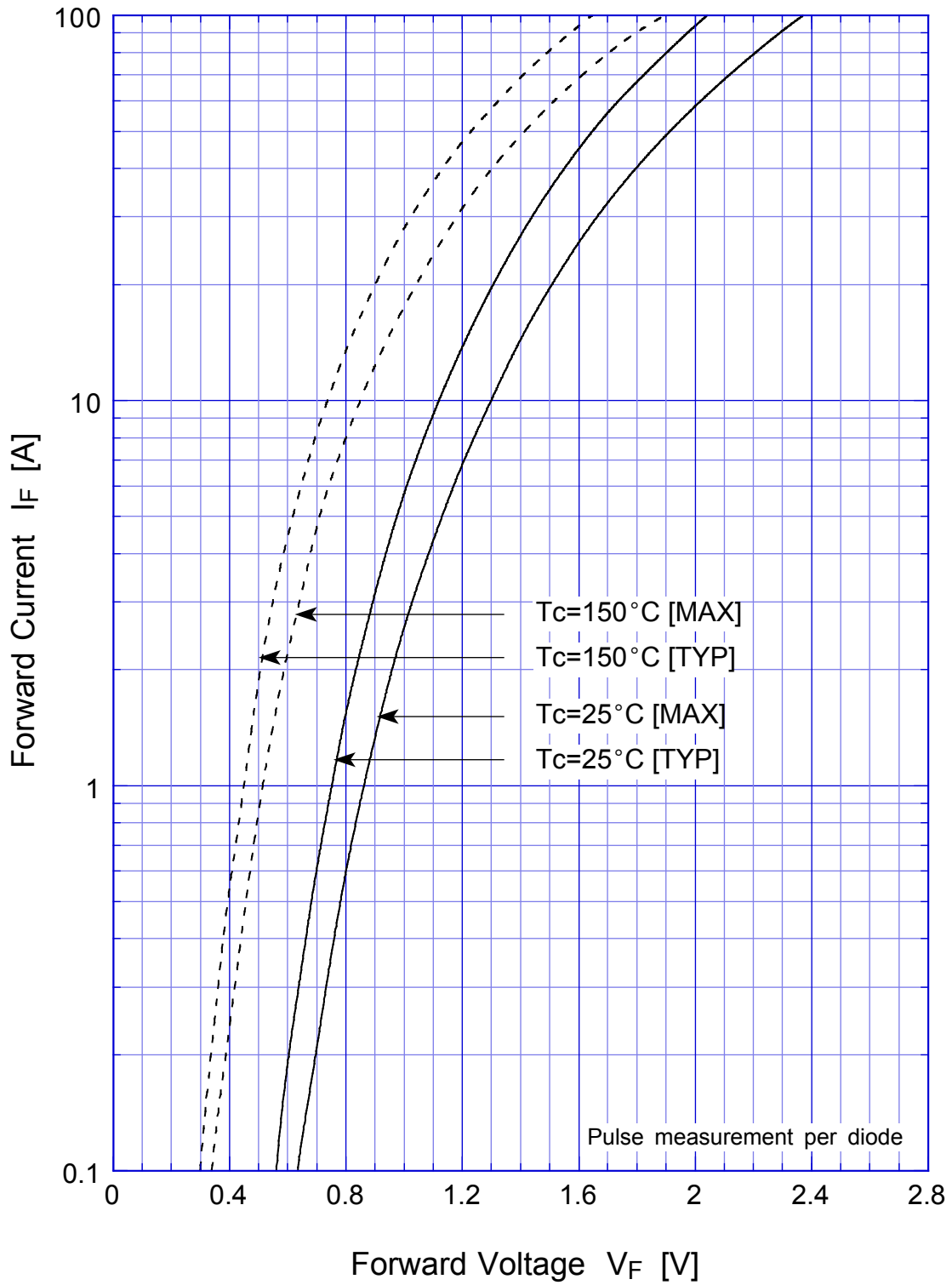

S20L60

Forward Power Dissipation

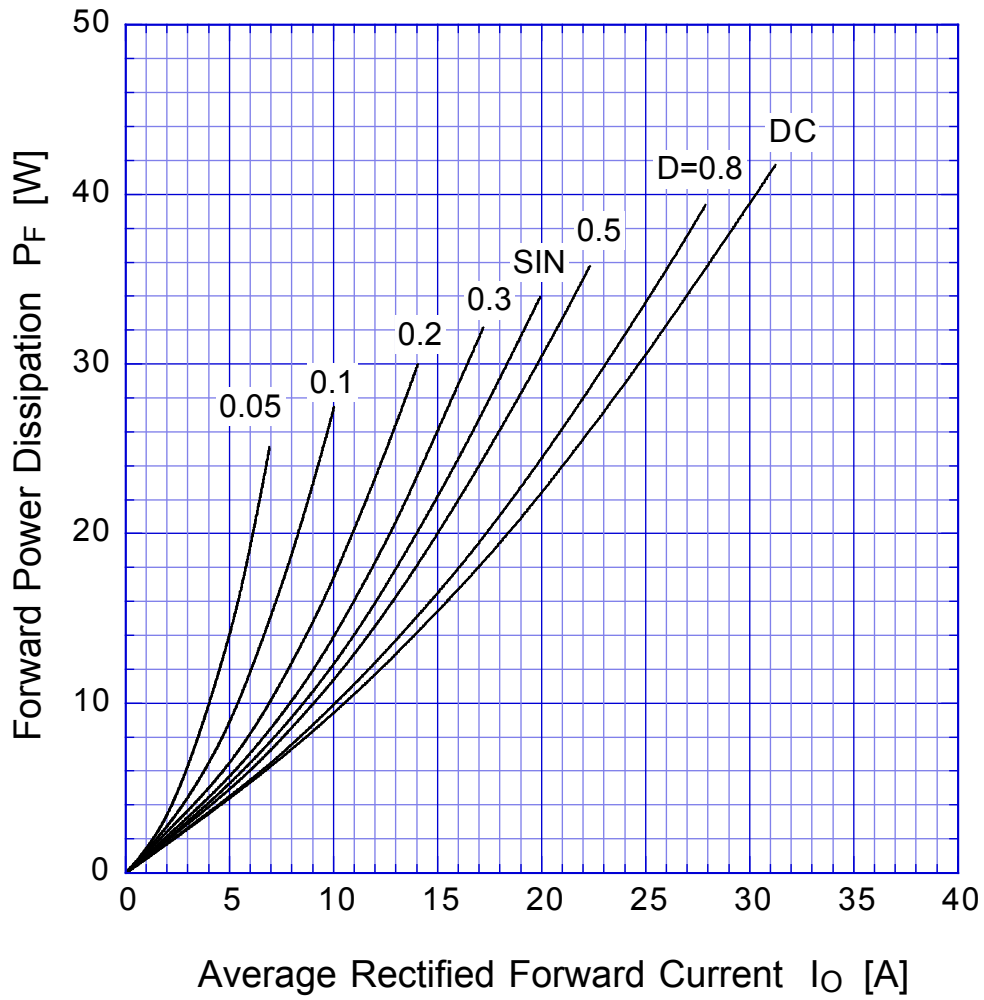

$T_j = T_{jmax}$

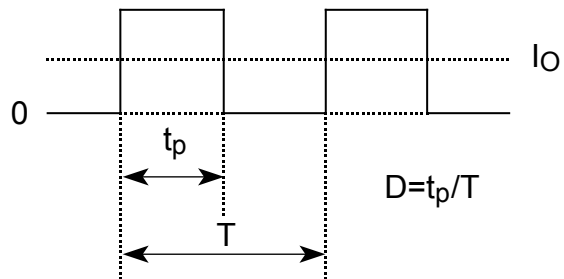

S20L60

Derating Curve

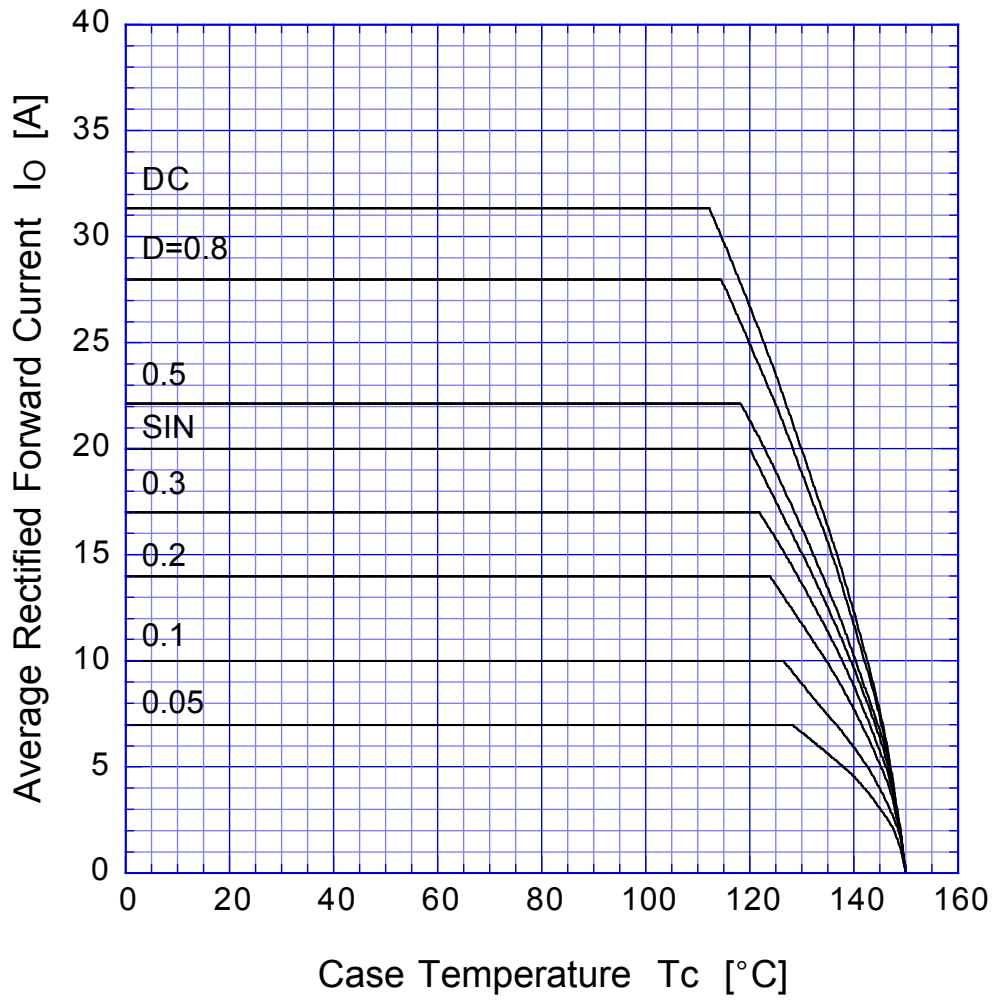

$$V_R = V_{RM}$$

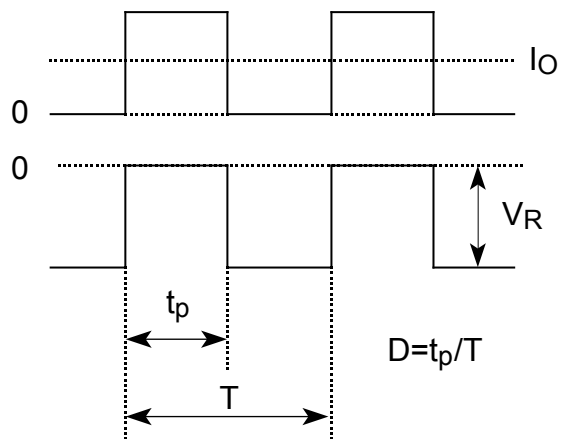

S20L60

Peak Surge Forward Capability

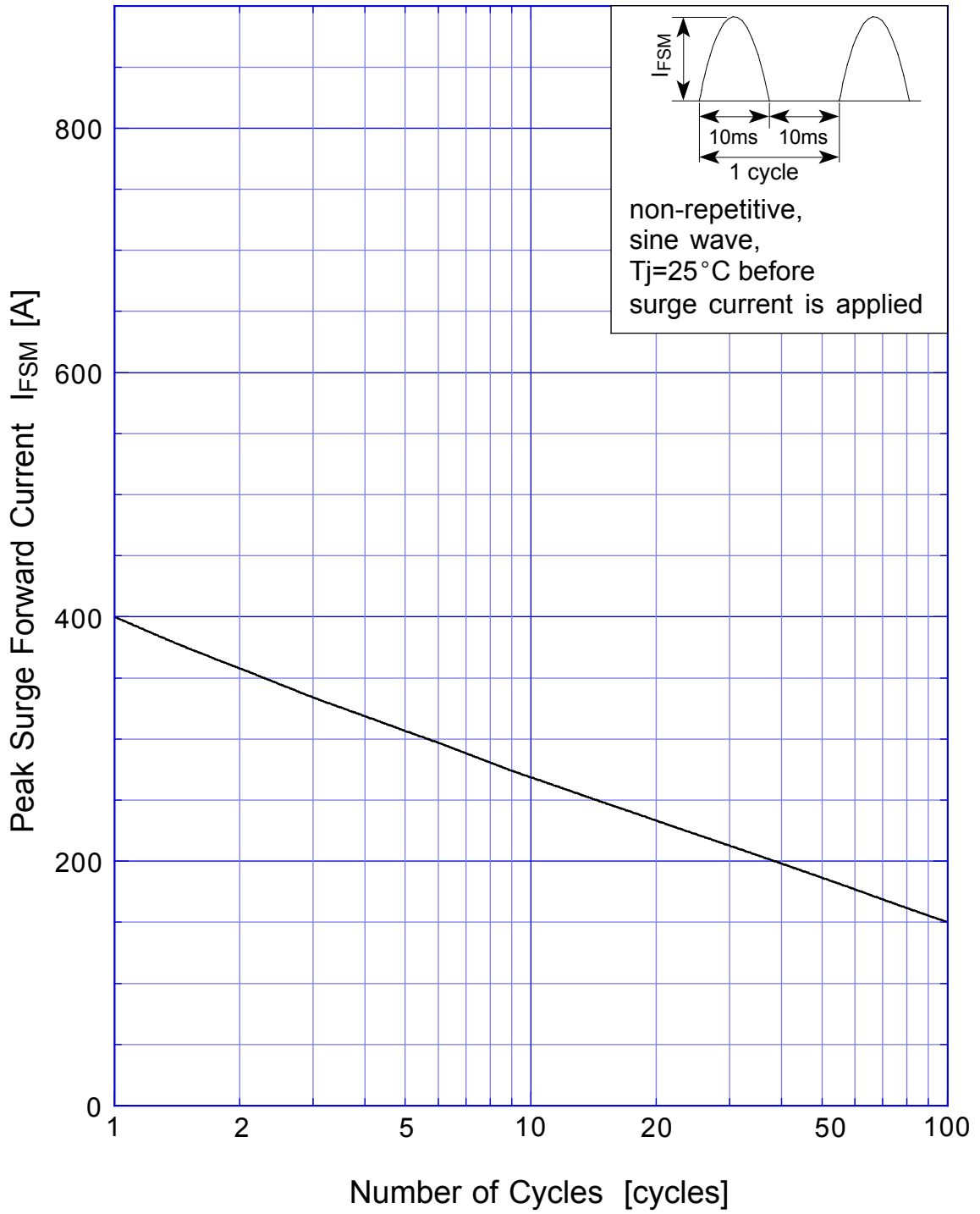

S20L60 Junction Capacitance

