

S22MD2

Photothyristor Coupler

■ Features

1. Long distance between anode and cathode of photothyristor on the output side : 5.08mm
 2. High repetitive peak OFF-state voltage (V_{DRM} : MIN. 600V)
 3. Low trigger current (I_{FT} : MAX. 8mA at $R_G = 20k\Omega$)
 4. High isolation voltage between input and output (V_{iso} : 5 000V_{rms})
- * S22MD2 is for 200V line.

■ Applications

1. ON-OFF operation for a low power load
2. For triggering high power thyristor and triac

■ Outline Dimensions

(Unit : mm)

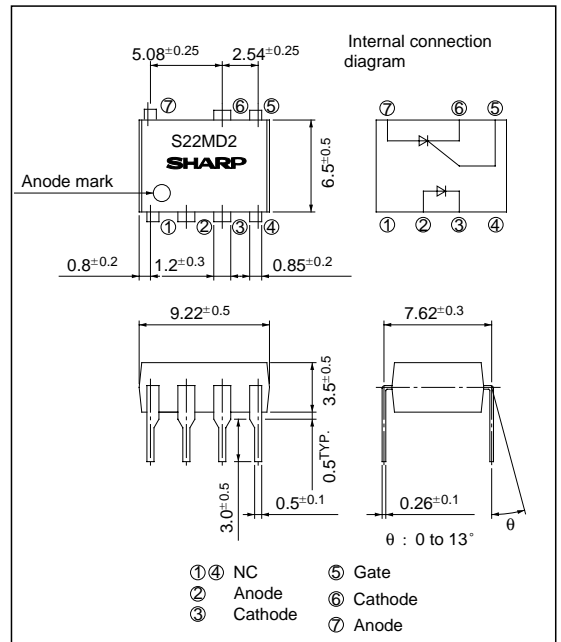

■ Absolute Maximum Ratings

($T_a = 25^\circ\text{C}$)

Parameter		Symbol	Rating	Unit
Input	Forward current	I_F	50	mA
	Reverse voltage	V_R	6	V
Output	RMS ON-state current	I_T	200	mA _{rms}
	*1 Peak one cycle surge current	I_{surge}	2	A
	*2 Repetitive peak OFF-state voltage	V_{DRM}	600	V
	*2 Repetitive peak reverse voltage	V_{RRM}	600	V
*3 Isolation voltage		V_{iso}	5 000	V _{rms}
Operating temperature		T_{opr}	- 30 to + 100	$^\circ\text{C}$
Storage temperature		T_{stg}	- 40 to + 125	$^\circ\text{C}$
*4 Soldering temperature		T_{sol}	260	$^\circ\text{C}$

*1 50Hz, sine wave

*2 $R_G = 20k\Omega$

*3 40 to 60% RH, AC for 1 minute

*4 For 10 seconds

■ Electro-optical Characteristics

($T_a = 25^\circ\text{C}$)

Parameter		Symbol	Conditions	MIN.	TYP.	MAX.	Unit
Input	Forward voltage	V_F	$I_F = 30\text{mA}$	-	1.2	1.4	V
	Reverse current	I_R	$V_R = 4\text{V}$	-	-	10^{-5}	A
Output	Repetitive peak OFF-state current	I_{DRM}	$V_{DRM} = \text{Rated}, R_G = 20\text{k}\Omega$	-	-	10^{-6}	A
	Repetitive peak reverse current	I_{RRM}	$V_{RRM} = \text{Rated}, R_G = 20\text{k}\Omega$	-	-	10^{-6}	A
	ON-state voltage	V_T	$I_T = 200\text{mA}$	-	1.0	1.4	V
	Holding current	I_H	$V_D = 6\text{V}, R_G = 20\text{k}\Omega$	-	0.3	1	mA
	Critical rate of rise of OFF-state voltage	dV/dt	$V_{DRM} = 1/\sqrt{2}$ Rated, $R_G = 20\text{k}\Omega$	3	-	-	V/ μs
Transfer-characteristics	Minimum trigger current	I_{FT}	$V_D = 6\text{V}, R_L = 100\Omega, R_G = 20\text{k}\Omega$	-	6	8	μA
	Isolation resistance	R_{ISO}	DC500V, 40 to 60% RH	5×10^{10}	10^{11}	-	Ω
	Turn-on time	t_{on}	$V_D = 6\text{V}, R_G = 20\text{k}\Omega, R_L = 100\Omega, I_F = 30\text{mA}$	-	20	50	μs

Fig. 1 RMS ON-state Current vs. Ambient Temperature

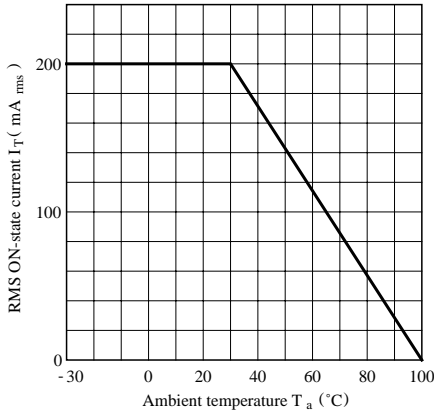

Fig. 2 Forward Current vs. Ambient Temperature

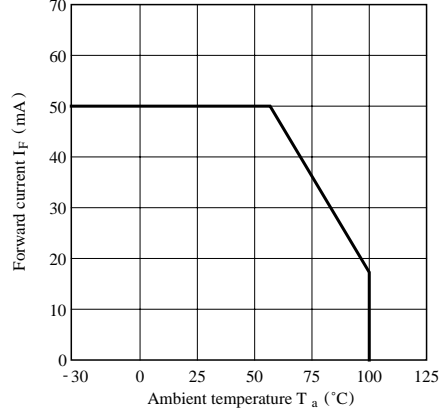

Fig. 3 Forward Current vs. Forward Voltage

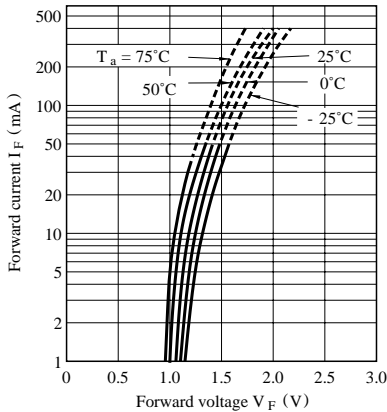

Fig. 4 Minimum Trigger Current vs. Ambient Temperature

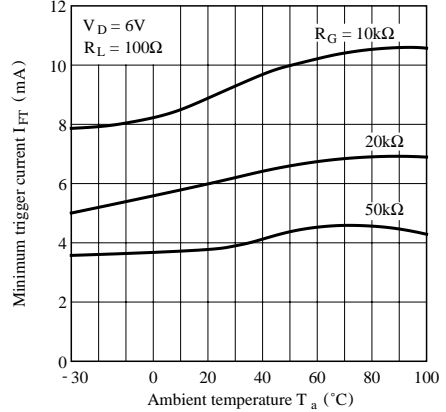

Fig. 5 Minimum Trigger Current vs. Gate Resistance

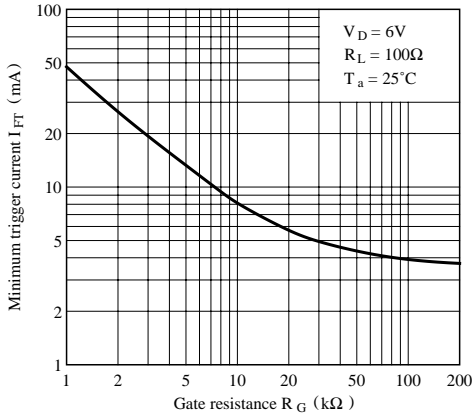

Fig. 6 Break Over Voltage vs. Ambient Temperature

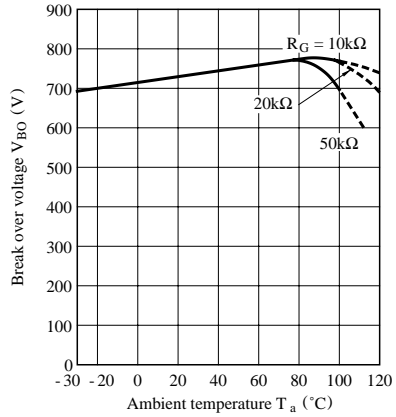

Fig. 7 Critical Rate of Rise of OFF-state Voltage vs. Ambient Temperature

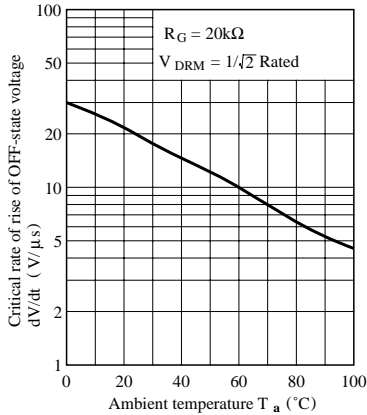

Fig. 8 Holding Current vs. Ambient Temperature

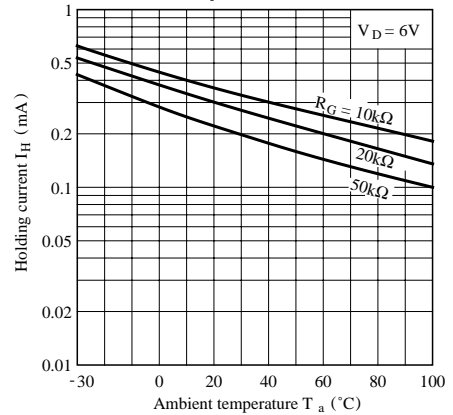
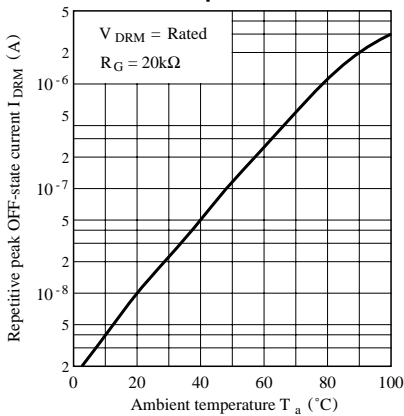
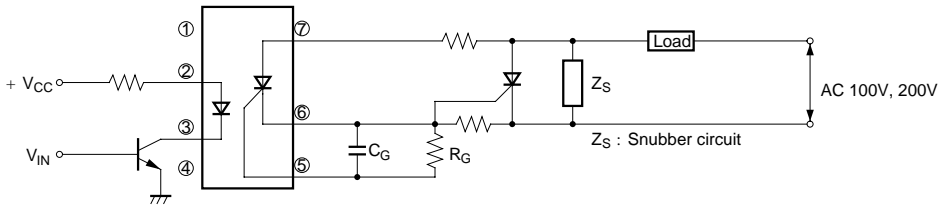

Fig. 9 Repetitive Peak OFF-state Current vs. Ambient Temperature



■ Basic Operation Circuit

Medium/High Power Thyristor Drive Circuit



Medium/High Power Triac Drive Circuit (Zero-cross Operation)

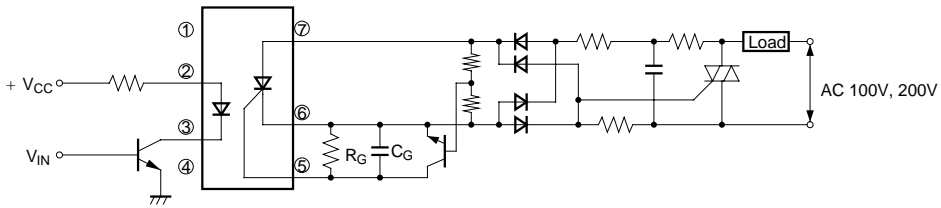

- Please refer to the chapter “Precautions for Use” (Page 78 to 93).