

# IS471F

## OPIC Light Detector with Built-in Signal Processing Circuit for Light Modulation System

### ■ Features

1. Impervious to external disturbing lights due to light modulation system
2. Built-in pulse driver circuit and sync. detector circuit on the emitter side
3. A wide range of operating supply voltage ( $V_{CC}$ : 4.5 to 16V)

### ■ Applications

1. Optoelectronic switches
2. Copiers, printers
3. Facsimiles

### ■ Outline Dimensions

(Unit : mm)

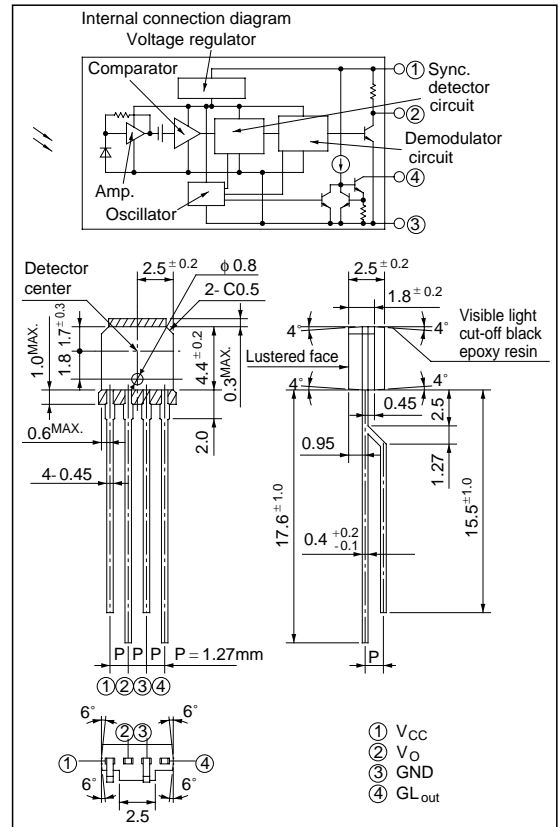

\*"OPIC" (Optical IC) is a trademark of the SHARP Corporation.  
An OPIC consists of a light-detecting element and signal-processing circuit integrated onto a single chip.

### ■ Absolute Maximum Ratings

(Ta= 25°C)

Parameter	Symbol	Rating	Unit	
Supply voltage	$V_{CC}$	-0.5 to 16	V	
Output	Output voltage	$V_O$	16	V
	Output current	$I_O$	50	mA
*1 GL output	Output voltage	$V_{GL}$	16	V
Power dissipation	P	250	mW	
Operating temperature	$T_{opr}$	-25 to +60	°C	
Storage temperature	$T_{stg}$	-40 to +100	°C	
*2 Soldering temperature	$T_{sol}$	260	°C	

\*1 Applies to  $GL_{out}$  terminal

\*2 For 5 seconds at the position shown in the right figure

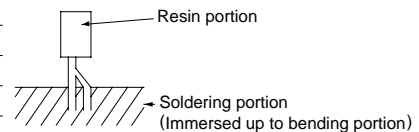

■ Electro-optical Characteristics

( $V_{CC}= 5V, T_a= 25^{\circ}C$ )

Parameter	Symbol	Conditions	MIN.	TYP.	MAX.	Unit
Operating supply voltage	$V_{CC}$	-	4.5	-	16	V
Supply current	$I_{CC}$	$V_o, GL_{out}$ terminals shall be opened.	-	3.5	7.0	mA
Output	Low level output voltage	$V_{OL}$ $I_{OL}= 16mA, E_{VP}= 500lx, E_{VD}= 0^{*3}$	-	0.15	0.35	V
	High level output voltage	$V_{OH}$ $E_{VD}= E_{VP}= 0^{*3}$	4.97	-	-	V
	Output short circuit current	$I_{OS}$ $E_{VP}= E_{VD}= 0^{*3}$	0.25	0.5	1.0	mA
GL output	Low level output current	$I_{GL}$ $V_{GL}= 1.2V$	40	55	70	mA
	<sup>*4</sup> Pulse cycle	$t_p$	70	130	220	$\mu s$
	<sup>*4</sup> Pulse width	$t_w$	4.4	8	13.7	$\mu s$
<sup>*5</sup> "Low→High" threshold irradiance	$E_{ePLH}$	$E_{eD}= 0^{*3}$ Light emitting diode ( $\lambda_p= 940nm$ ) <sup>*6</sup>	-	0.4	2.66	$\mu W/mm^2$
<sup>*5</sup> "High→Low" threshold irradiance	$E_{ePHL}$		-	0.7	2.8	$\mu W/mm^2$
Hysteresis	$E_{ePLH} / E_{ePHL}$		0.45	0.65	0.95	-
Response time	"High→Low" propagation delay time	$t_{PHL}$	*6	400	670	$\mu s$
	"Low→High" propagation delay time	$t_{PLH}$	*6	400	670	$\mu s$
<sup>*7</sup> External disturbing light illuminance	$E_{VDX}$	$E_{ep}= 7.5 \mu W/mm^2, ^{*3}\lambda_p= 940nm$	2000	7500	-	lx

<sup>\*3</sup>  $E_{eP}$  represents illuminance of signal light in sync with the low level timing of output at  $GL_{out}$  terminal.

$E_{eD}$  represents illuminance of DC light. For detail, see Fig. 1.

Light source: Infrared light emitting diode ( $\lambda_p= 940nm$ )

$E_{VP}$  represents illuminance of signal light in sync with the low level timing of output at  $GL_{out}$  terminal.

$E_{VD}$  represents illuminance of DC light. Note that the light source is CIE standard light source A.

Fig.1

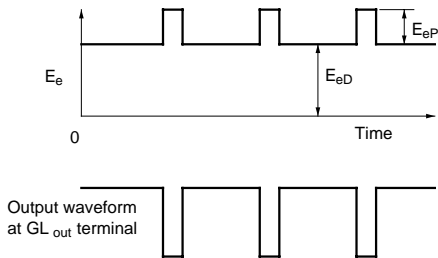

(Note) Fig. 1 shows the output waveform at  $GL_{out}$  terminal with **IS471F** connected as shown in Fig. 3.

<sup>\*4</sup> Pulse cycle ( $t_p$ ), pulse width ( $t_w$ ) are defined as shown in Fig. 2.

The waveform shown in Fig. 2 is the output voltage waveform at  $GL_{out}$  terminal with **IS471F** connected as shown in Fig. 3

Fig.2

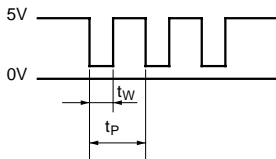
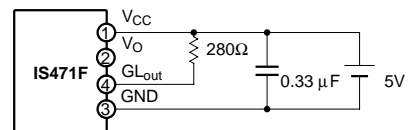

Fig.3



<sup>\*5</sup> Defined as  $E_{ep}$  that causes the output to go " Low to High" (or " High to Low" ).

\*6 Test circuit for response time, threshold irradiance is shown in Fig. 4.

Fig. 4

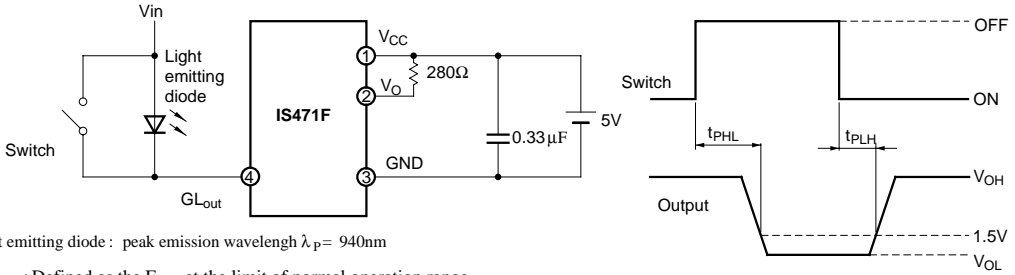

\*7  $E_{VDX}$ : Defined as the  $E_{VD}$  at the limit of normal operation range.

Fig. 5 Power Dissipation vs. Ambient Temperature

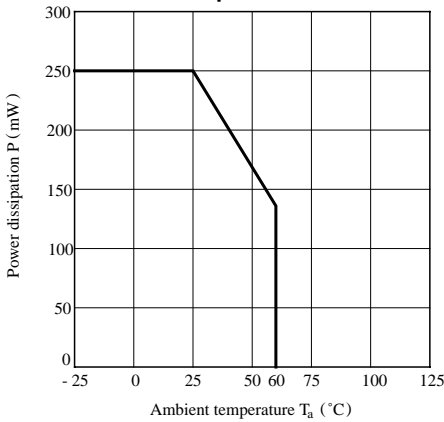

Fig. 6 Low Level Output Voltage vs. Low Level Output Current

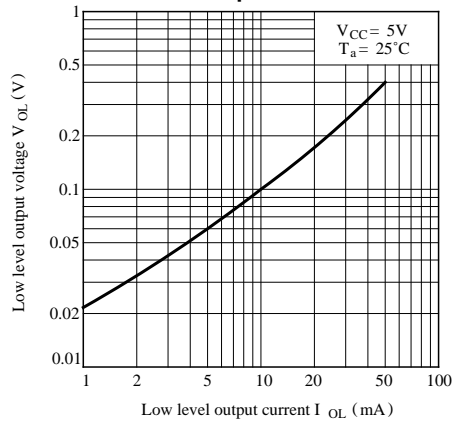

Fig. 7 Low Level Output Voltage vs. Ambient Temperature

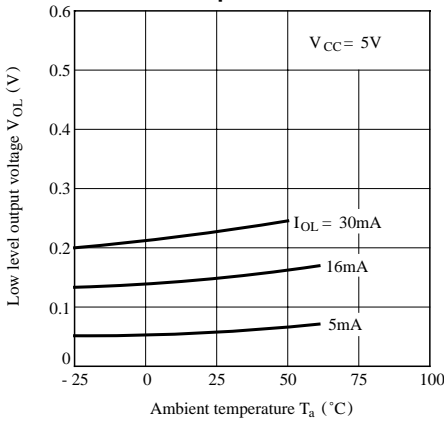
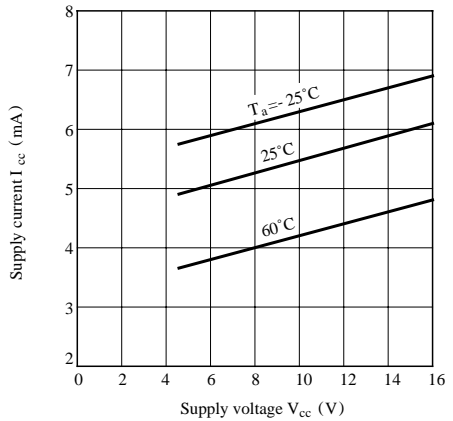
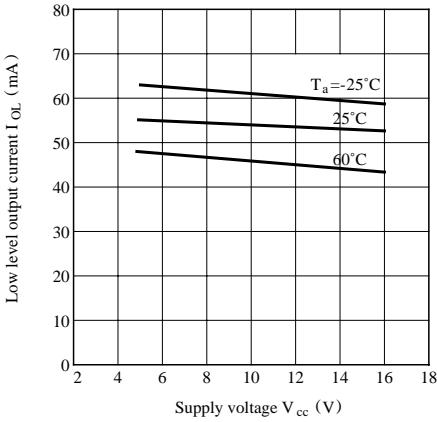

Fig. 8 Supply Current vs. Supply Voltage



**Fig. 9 Low Level Output Current vs. Supply Voltage**



**Fig.10 Sensitivity Diagram ( $T_a = 25^\circ\text{C}$ )**

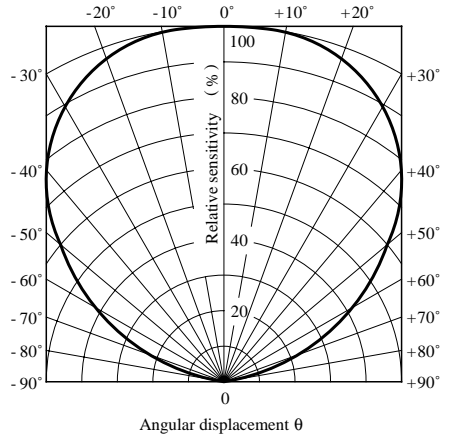

**Fig.11 Spectral Sensitivity**

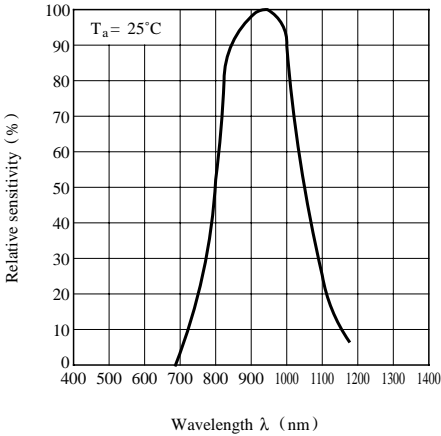

■ **Basic Circuit**

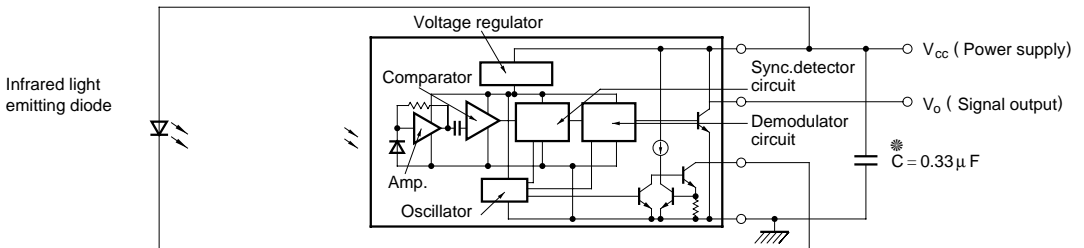

⊛ In order to stabilize power supply line, connect a by-pass capacitor of 0.33 $\mu\text{F}$  or more between  $V_{cc}$  and GND near the device.

● Please refer to the chapter “Precautions for Use.”