

SHINDENGEN

Schottky Rectifiers (SBD)

Dual

S60SC6M

60V 60A

FEATURES

- Tj150
- P_{RRSM} avalanche guaranteed
- Small j_c
- High current capacity

APPLICATION

- Switching power supply
- DC/DC converter
- Home Appliances, Office Equipment
- Telecommunication

OUTLINE DIMENSIONS

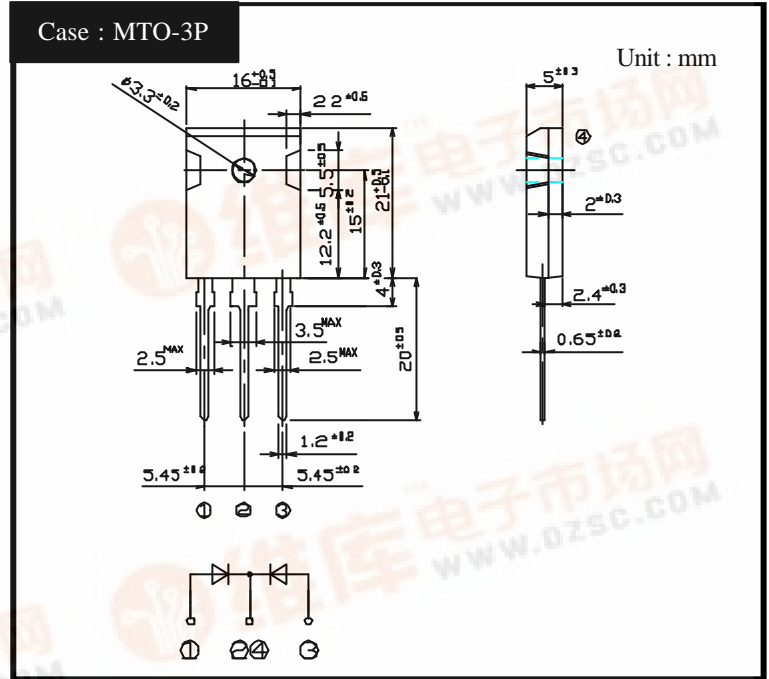

RATINGS

Absolute Maximum Ratings (If not specified T_c=25)

| Item | Symbol | Conditions | Ratings | Unit |
|---------------------------------------|-------------------|--|-----------|------|
| Storage Temperature | T _{stg} | | -40 ~ 150 | |
| Operating Junction Temperature | T _j | | 150 | |
| Maximum Reverse Voltage | V _{RM} | | 60 | V |
| Repetitive Peak Surge Reverse Voltage | V _{RRSM} | Pulse width 0.5ms, duty 1/40 | 65 | V |
| Average Rectified Forward Current | I _o | 50Hz sine wave, R-load, Rating for each diode I _o /2, T _c =118 | 60 | A |
| Peak Surge Forward Current | I _{FSM} | 50Hz sine wave, Non-repetitive 1 cycle peak value, T _j =125 | 500 | A |
| Repetitive Peak Surge Reverse Power | P _{RRSM} | Pulse width 10 μs, Rating of per diode, T _j =25 | 1000 | W |
| Mounting Torque | TOR | (Recommended torque 0.5N·m) | 0.8 | N·m |

Electrical Characteristics (If not specified T_c=25)

| Item | Symbol | Conditions | Ratings | Unit |
|----------------------|----------------|--|----------|------|
| Forward Voltage | V _F | I _F =30A, Pulse measurement, Rating of per diode | Max.0.67 | V |
| Reverse Current | I _R | V _R =V _{RM} , Pulse measurement, Rating of per diode | Max.20 | mA |
| Junction Capacitance | C _j | f=1MHz, V _R =10V, Rating of per diode | Typ.850 | pF |
| Thermal Resistance | j _c | junction to case | Max.0.5 | /W |



S60SC6M Forward Voltage

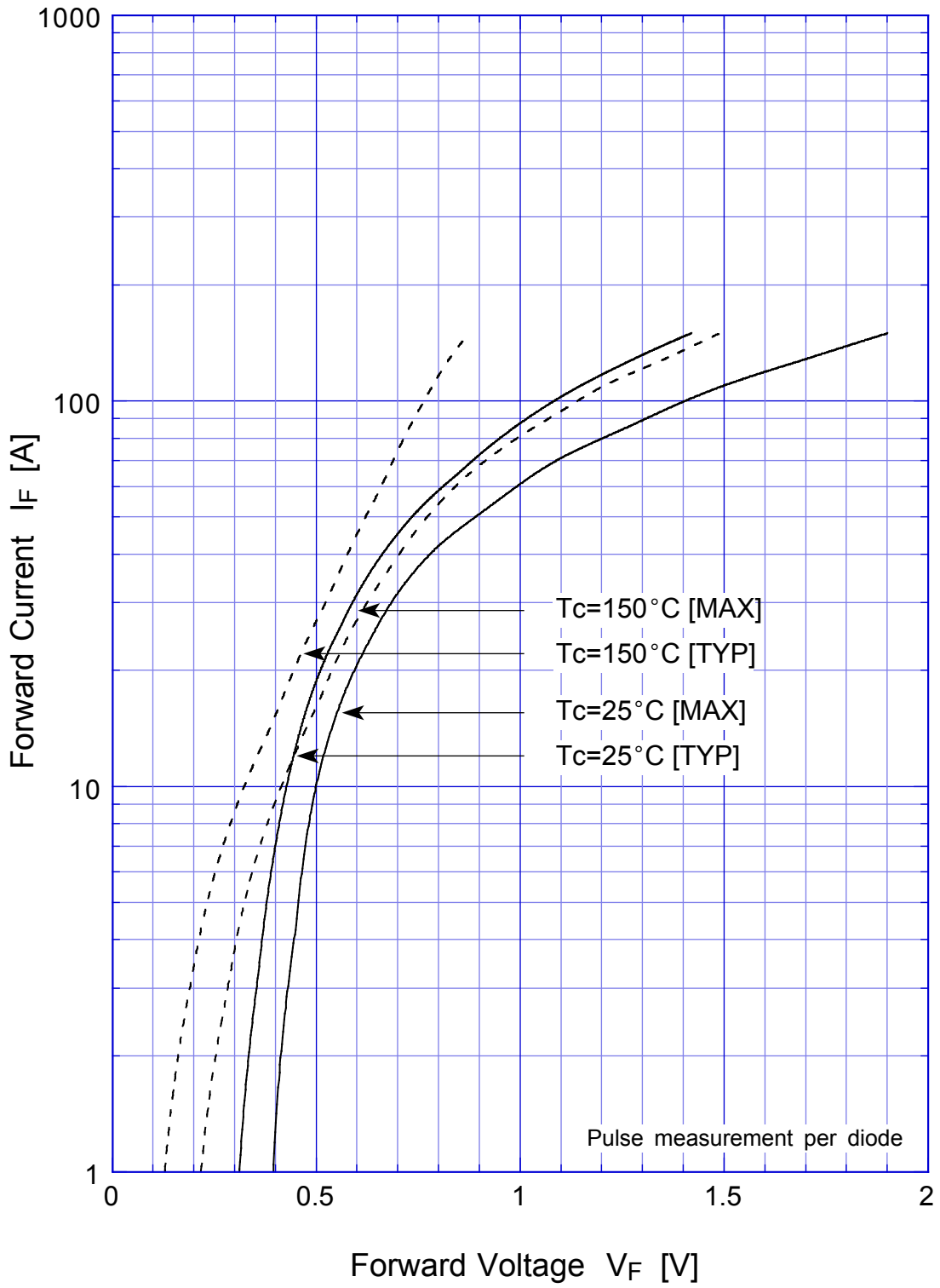

S60SC6M Junction Capacitance

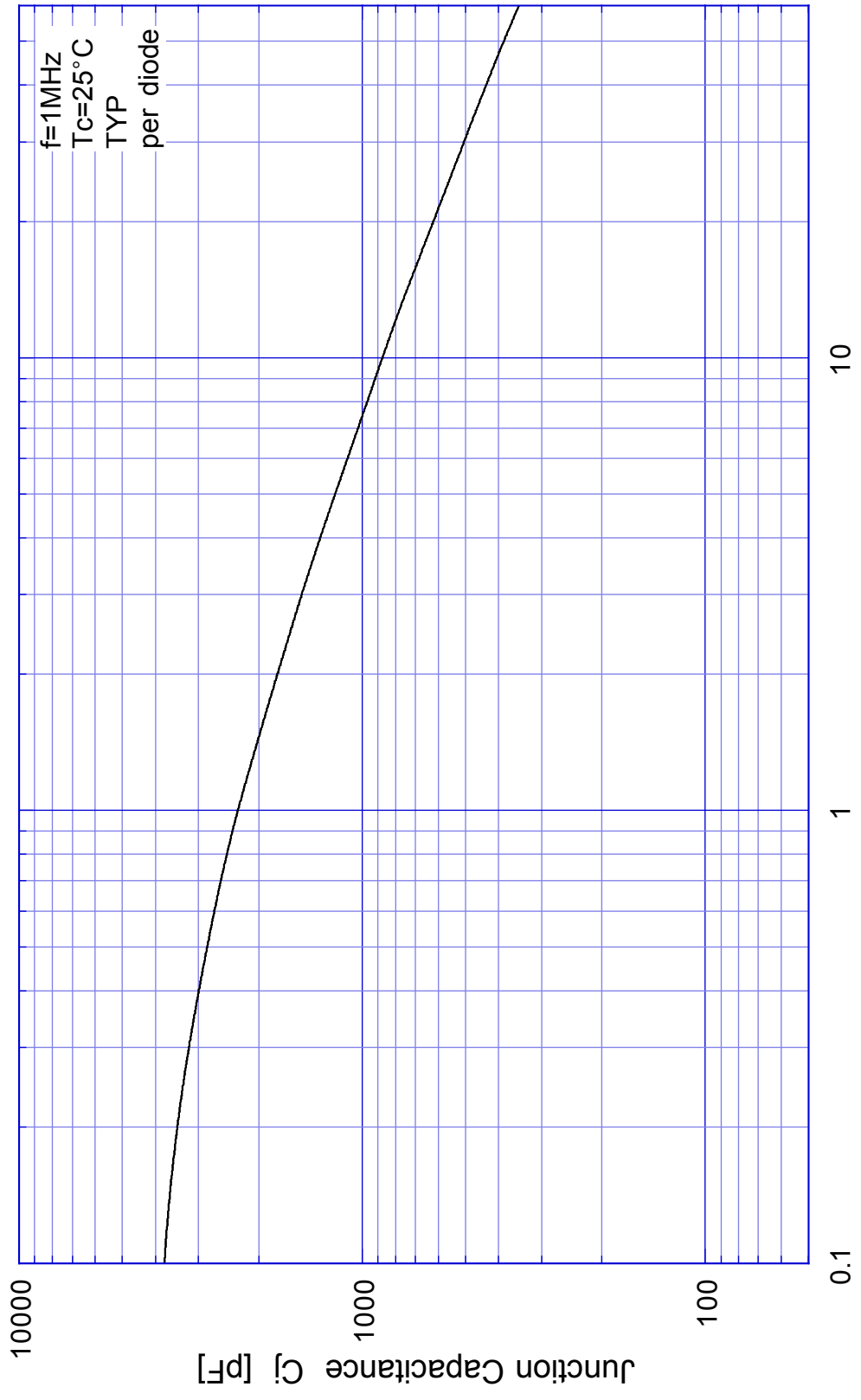

Reverse Voltage V_R [V]

S60SC6M Reverse Current

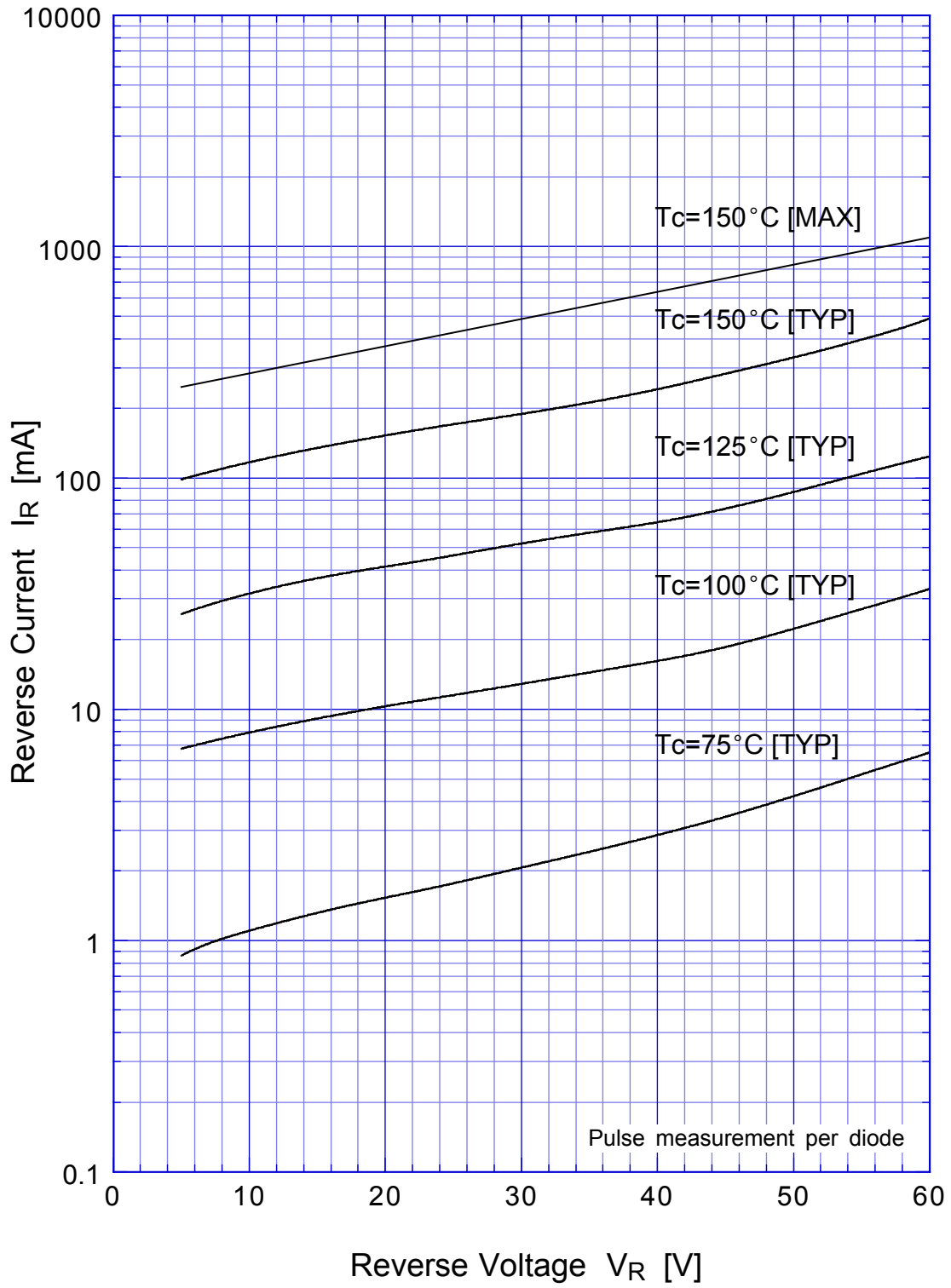

S60SC6M Reverse Power Dissipation

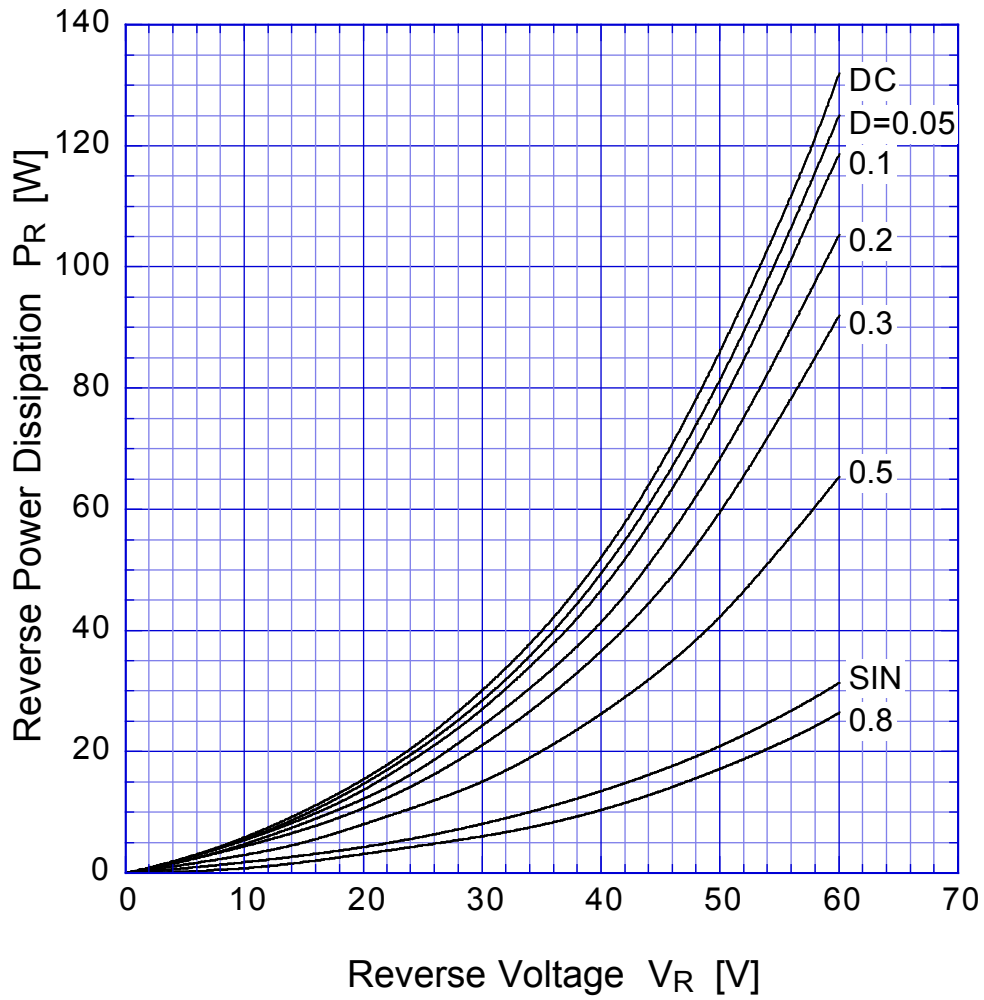

$T_j = 150^\circ\text{C}$

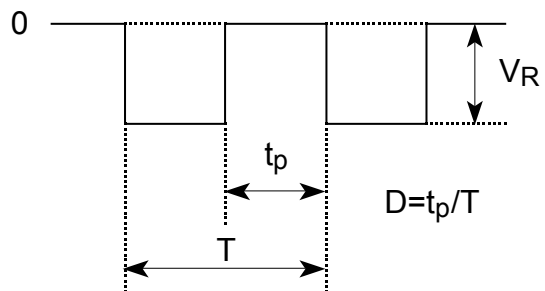

S60SC6M Forward Power Dissipation

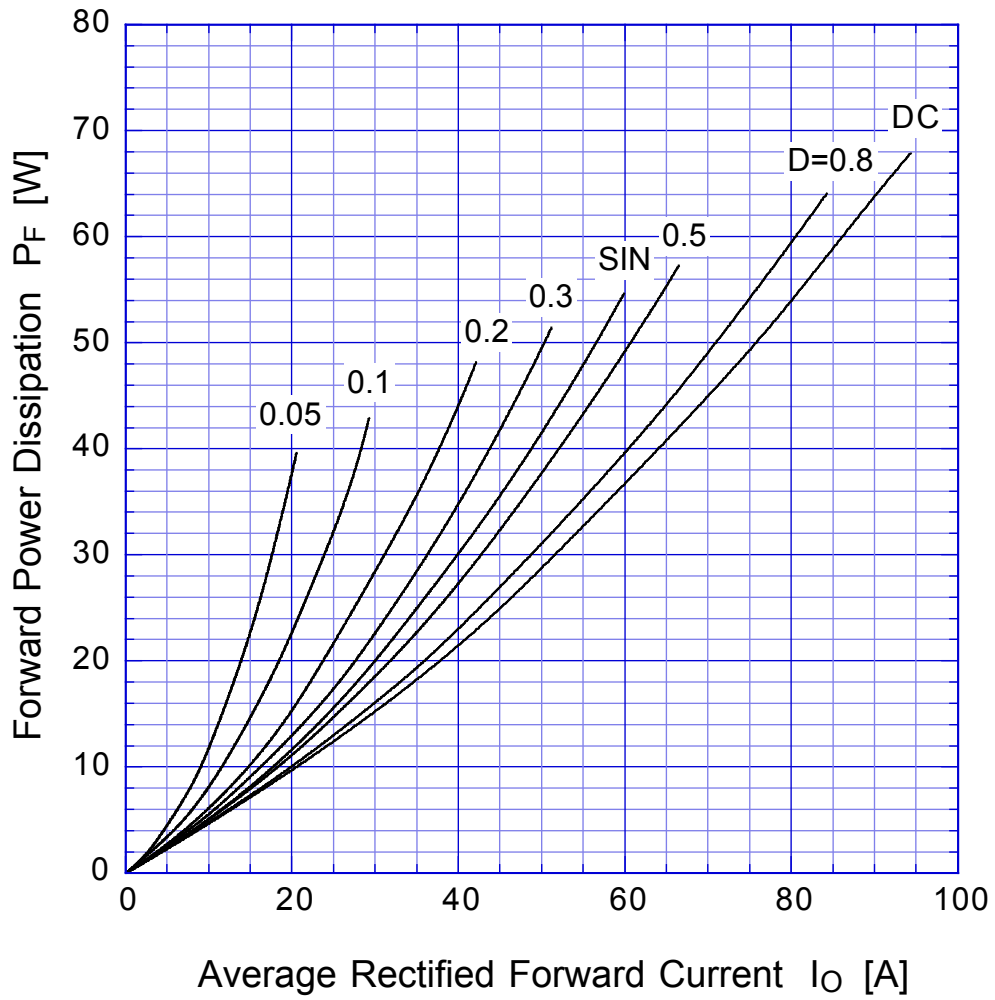

$T_j = 150^\circ\text{C}$

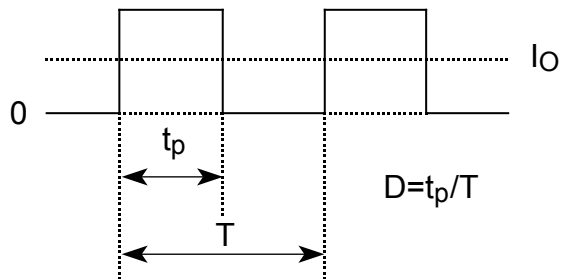

S60SC6M

Derating Curve

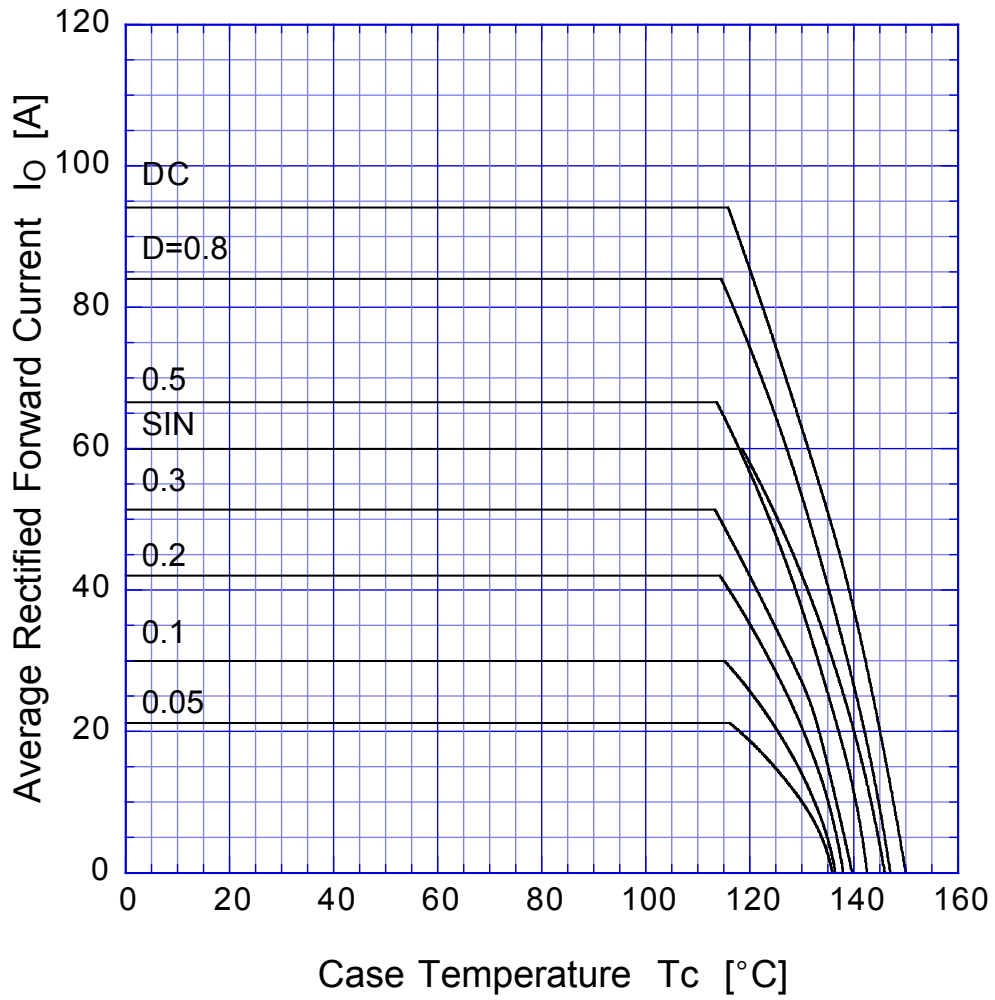

$V_R = 30V$

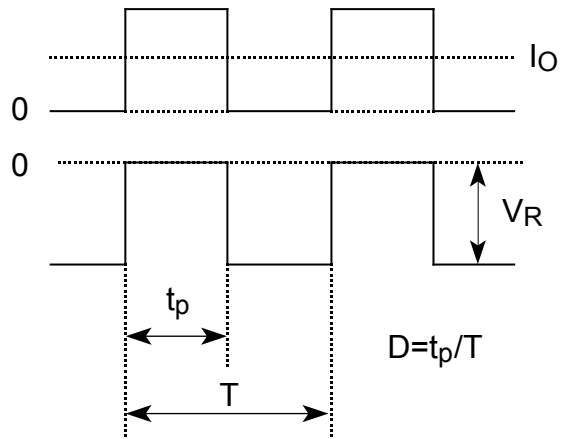

S60SC6M Peak Surge Forward Capability

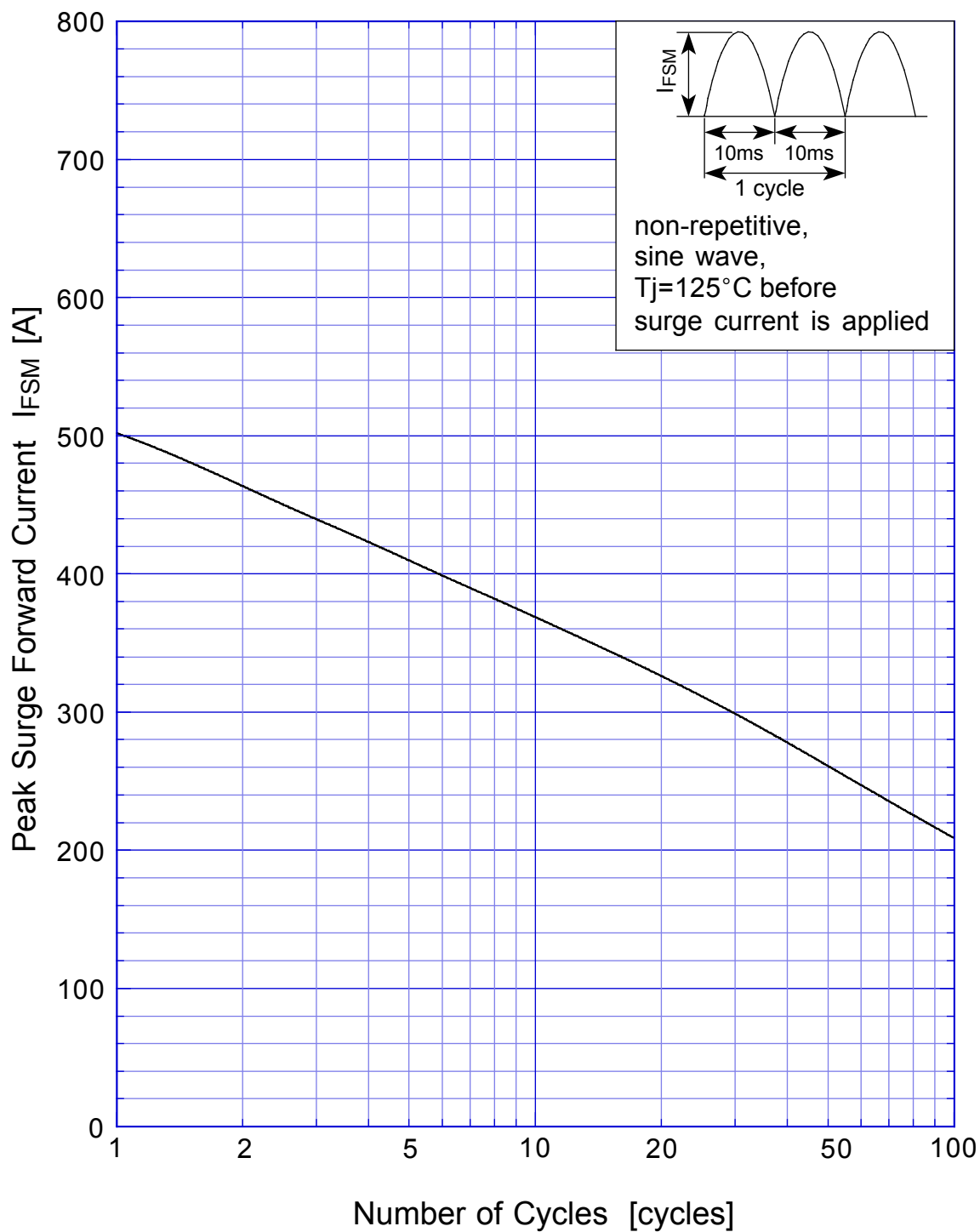

SBD Repetitive Surge Reverse Power Derating Curve

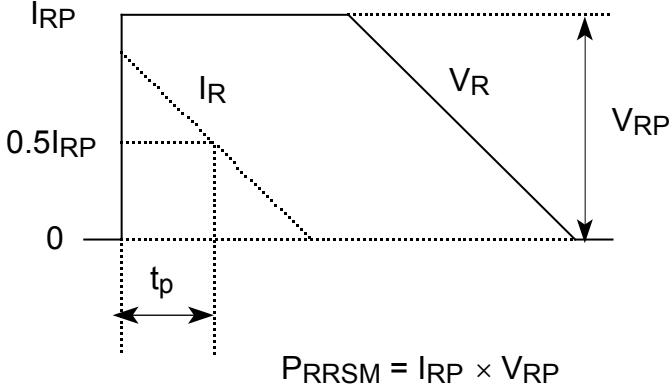
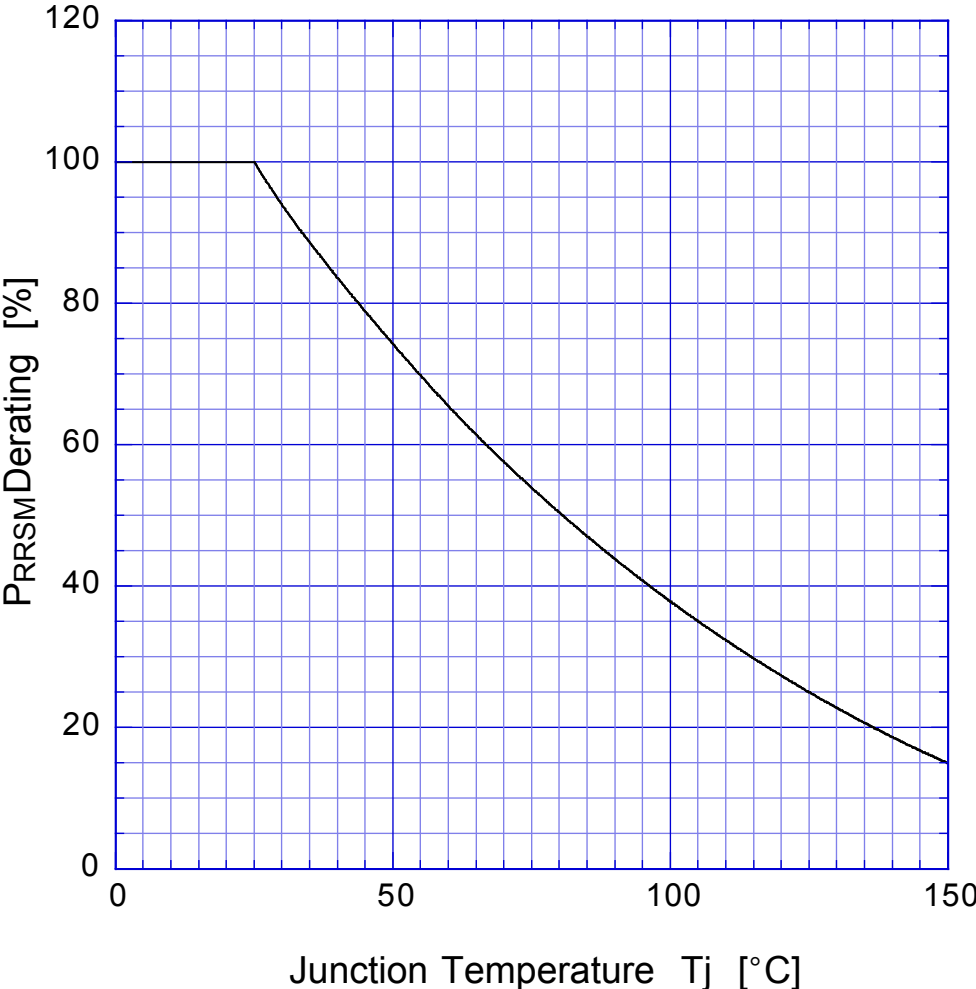

SBD

Repetitive Surge Reverse Power Capability

